

Determining the Acceptable Ranges of Relative Humidity And Temperature in Museums and Galleries

**Marion F. Mecklenburg
Smithsonian Museum Conservation Institute.**

Part 1, Structural Response to Relative Humidity

Introduction

If one attempts to interpret the temperature and relative humidity (RH) information developed for Smithsonian Facilities Management (or any institution for that matter) it would be most useful to look at the raw data from monitors at individual sites. At the Smithsonian, the current environmental guidelines are 45% RH +/- 8% RH and 70° F +/- 4° F for exhibitions and storage spaces. (Mecklenburg et al, 2004) This simply means it is acceptable to be within a RH and temperature box bounded between 37% RH and 53% RH and 66° F and 74° F.

Since the actual data is taken on an hourly basis over a 30 day period one can actually see the excursion events in terms of time and magnitude. This data can be interpreted in such a way that it shows both the actual HVAC system performance and allows a detailed analysis in terms of whether an excursion is actually causing problems for the collections. For example, does a 4 hour depression in RH of 4%-5% outside the allowable bandwidth have a significant impact on the chemical and structural stability of the collection? To answer that question one needs to know what the actual, allowable, RH and temperature ranges are and to examine the time it takes for moisture to enter or leave materials when there is a change in relative humidity.

Before discussing the rate of moisture absorption it would be useful to review some fundamental issues. This includes how the guidelines were originally established and what were the criteria used? Another fundamental issue is how to interpret the hourly monitoring temperature and RH data.

Setting the Initial Criteria for Establishing Environmental Guidelines

When originally developed, the environmental guidelines required criteria from which to work. For example if wood or glue samples were restrained and desiccated, they would develop stresses. The questions that needed answers were; how much depression or elevation in RH would be sufficient to cause failure and how much change could the material withstand without damage? Damage can mean either permanent deformation or actual cracking. Since it is possible to directly relate humidity changes in a material under restraint to the mechanical stresses and strains developed from external loading sources, it becomes possible to develop criteria for the allowable RH fluctuations. (Mecklenburg and Tumosa, 1996)

This approach required determining the mechanical properties and the dimensional responses for the materials at different levels of relative humidity and temperature.

- The first criterion established was to simply assume that every material in the Smithsonian Institution collections was **fully restrained** from dimensional response. This is not necessarily true in all cases but it establishes a worst case condition for most if not all of the collections. A typical example of constrained materials would be wood veneer bonded cross grained over a wood substrate.
- The second criterion is that the restrained materials are **initially free of stress**. Exceptions will be discussed later in this paper.
- The third criterion selected was that the mechanical strains of the material should **never exceed the yield point either in tension or compression**. The yield point defines the upper limit of the elastic (reversible) region of a material's mechanical performance. Loading the material above the yield point induces plastic (permanent) deformation in the material. Even this might be quite small, however.

There has been some uncertainty regarding the dimensional behavior of hygroscopic materials and it is important to show the behavior of very responsive materials. The rigid materials that have the most humidity-related dimensional response are typically woods, glues, and ivory. The flexible materials that have moderate to high dimensional response to relative humidity can include papers, parchments, and textiles. Materials that might be considered to have moderate to low dimensional response to relative humidity include gessoes and oil, alkyd, and tempera paints. For purposes of clarifying the dimensional response of a material to moisture changes it would be useful to describe wood.

The Dimensional Response of Wood

Over centuries, wood has been the material of choice for panel supports for tempera and oil paintings, furniture, structural systems in buildings and a thousand other things. It is still used today and is a material that is very hygroscopic. From both the dimensional and mechanical response to relative humidity wood is said to be orthotropic, that is it responds differently in the three primary and mutually perpendicular directions. Those three directions are the longitudinal direction which is the direction parallel to the grain of the wood (L), the radial direction which is perpendicular to the concentric rings of wood (R), and the tangential direction (T) which is tangent to the concentric rings in wood (Fig. 1).

Figure 1 also shows the RH-related free swelling response in the three primary directions for modern Scotch pine. Wood cut in the tangential direction is the most responsive and is to be avoided when making panel paintings. Wood cut in the radial direction is best for panel paintings since it is typically less than half as responsive as the tangentially cut wood. The least responsive direction is the longitudinal direction. When drying out wood logs tend to crack in the radial

direction (Fig. 2.) Ivory on the other hand is most responsive in the radial direction. That is why ivory tends to crack in concentric rings when exposed to excessively large changes in moisture content (Fig. 3).

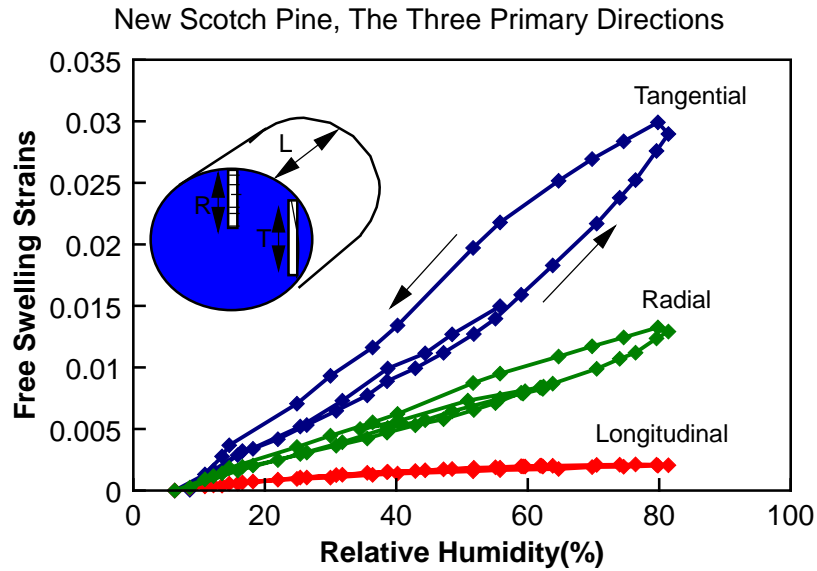

Figure 1, the swelling response to large changes in relative humidity of wood samples in the three primary directions for modern Scotch pine. The most responsive direction is the tangential direction followed by the radial direction. The longitudinal direction is only minimally responsive to changes in moisture content. The woods used for painting stretchers and panels are best cut in the radial direction since they exhibit the least dimensional response to changes in relative humidity.



Figure 2 shows the cracks along the radii of a section of Douglas fir from an Aztec ruin in N.M. cut in A.D. 1240. (Samples courtesy of the Laboratory of Tree-Ring Research, The University of Arizona, Tucson.)



Figure 3 shows the concentric cracks in a mammoth tusk. The cracks formed in this manner since the radial direction of the tusk is the weakest and the most dimensionally responsive to moisture. (Photo courtesy of Wikipedia)

Figure 4 shows the swelling response to large and small changes in relative humidity of 17th century Scotch pine grown in the same forest in Norway as the modern wood discussed in Fig. 1. The tangential direction shown is the most responsive direction and shows entirely different behavior depending on both the direction and magnitude of the changes in relative humidity.

When looking at large changes in relative humidity, the humidification plot is much lower than the desiccation plot. This difference in the paths is called hysteresis.

When there is a much more moderate change in relative humidity, the rate of dimensional response is much reduced and the moisture paths are almost the same. The slopes of the swelling plots shown are the estimated coefficients of moisture expansion as a function of relative humidity. The value of the slope for the large desiccating change in relative humidity is $0.00071 / \%RH$. The slope of the dimensional change for the smaller range in relative humidity is considerably less, ($0.000417 / \%RH$). This difference in rates helps explain why many materials survive uncontrolled but moderate environmental changes.

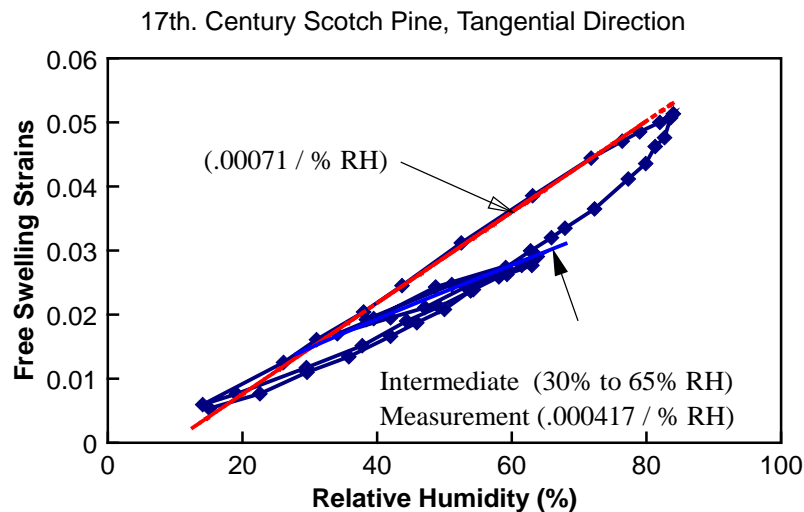

Figure 4, the swelling response to large and small changes in relative humidity of 17th century Scotch pine grown in the same forest in Norway as the modern wood discussed in Fig. 1. The tangential direction shown is the most responsive direction and shows entirely different behavior depending on the magnitude of the change in relative humidity.

It is critical to note that many cultural materials experience hysteresis and different rates of dimensional response depending on the magnitude of the changes in relative humidity. These differences will be illustrated in the plots that follow.

Establishing RH Boundaries Using the Yield Point Criterion for Materials with Large Dimensional Responses

This section of the discussion will illustrate how RH boundaries are determined when using the yield point criterion. It would also be useful to include some of the materials having the most RH-related dimensional response. These materials include wood, hide glue, and ivory. All of the

examples shown are typical of their groups of materials. For example the cotton wood illustrated below is one of the most dimensionally responsive of all of the woods tested. In many woods such as mahogany, teak and, red woods the dimensional response to moisture is considerably less. When testing the different types of animal glues, bovine, porcine, sturgeon and the photographic gelatins, it was found that the dimensional response to moisture was nearly identical. Their mechanical properties differ largely in term of their strength but all can be considered to be very strong materials. Ivory comes from the tusks (modified teeth) of mammals and is structurally similar regardless of the source species. Ivory is also a collagenous material similar to animal glues and gelatin.

Woods

When first evaluating any material it is necessary to examine its mechanical properties when exposed to different levels of RH. Figure 5 shows the tensile stress-strain tests for cotton wood in the tangential direction. Cotton wood, also known as European poplar, was just one of many woods tested because it was used extensively in European panel paintings. (Richard et al, 1998)

The tangential direction of any wood is the most dimensionally responsive to RH and it is also the weakest. The horizontal scale (Fig. 5) is in units of **strain which is the change in length divided by the sample original length**. The vertical scale is in stress where the units are in pound per square inch (psi). **Stress is calculated by taking the force (load) applied to the sample and dividing by the cross-sectional area** of the test sample. The end of the test is when the material breaks. The stress reached when the material fails is called the strength of the material. The strain reached when the material fails is called the strain to failure. The initial strain of 0.005 shown in the figure is the initial yield point and defines upper limit of the elastic or reversible range of the wood. When the wood is strained beyond the yield point it is said to undergo plastic or non-reversible behavior. The modulus of any materials is the ratio of the stress to strain in the elastic region only. It is a measure of the stiffness or flexibility of the material.

One of the most telling features of wood is that for the relative humidity ranges shown, there is not a dramatic effect on the mechanical properties. There is no significant stiffening or embrittlement of the wood at low relative humidity nor does it loose significant strength at high levels of relative humidity. In general, woods lose strength and become very flexible at very high levels of RH. Some woods can become quite stiff and brittle when the RH reaches levels below 10%. It is important to note the location of the yield point at 0.005 in relation to the breaking strains that range from 0.012 to about 0.2 as shown Fig. 5. The wood must be stretched considerably beyond the yield strain before it actually breaks.

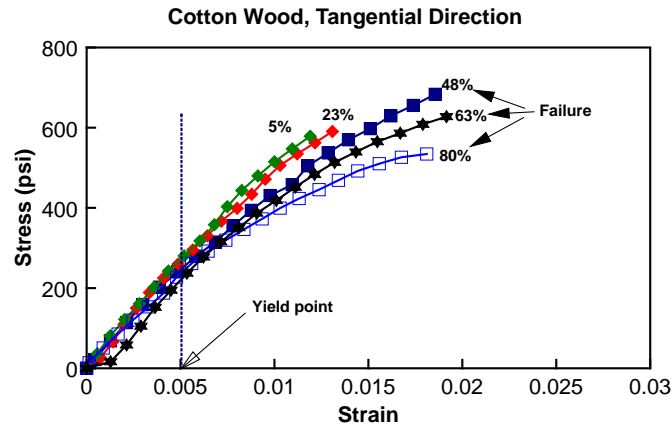

Figure 5 shows the tensile stress-strain tests for cotton wood in the tangential direction. The tangential direction of any wood is the most dimensionally responsive to RH and it is also the weakest. The yield point is indicated by the arrow at a strain 0.005. This is considerably lower than the strain required to cause the wood to actually break.

Figure 6 shows the dimensional response of tangentially cut cotton wood to both large and intermediate changes in relative humidity. The intermediate RH ranges are still fairly large and easily exceed the recommended museum control RH ranges. There is actually a family of the intermediate dimensional response ranges and two of them are shown in this figure. Also shown in this figure are the allowable RH fluctuations if the yield point of 0.005 had been used as the criterion for environmental RH limits.

The allowable fluctuations shown range between 32% RH and 62% RH as compared to the guidelines recommendation of 37% RH and 53% RH. This means that the wood is behaving in a fully elastic and reversible manner in a RH range greater than the recommended museum guidelines. It also means that the change in relative humidity has to be greater still to cause the wood to break.

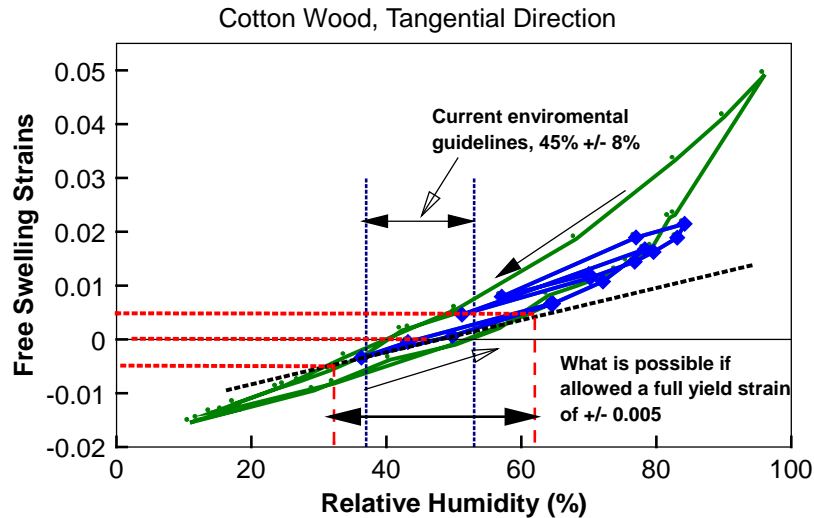

Figure 6 shows the allowable RH fluctuations if the yield point of 0.005 had been used as the criterion for environmental RH limits. These fluctuations range between 32% RH and 62% RH as compared to the guidelines recommendation of 37% RH and 53% RH.

Hide Glue

Hide glue (gelatin) is also a RH-responsive material and it is present in nearly all cultural collections. It is found as the adhesive for bonding parts and veneers in wood furniture, it is used as the size in traditional canvas paintings and some watercolor papers, and it is used to make gesso. When refined into gelatin, it is used as the image emulsion in photographic materials.

Figure 7 shows the tensile stress-strain tests for hide glue at different RH levels. At low RH levels the material is still ductile and not brittle. At high humidity levels hide glue loses strength and this is a critical factor in moisture related damage to paintings. The yield point, the limit of elastic behavior, used for all of the plots is indicated by the arrow, at a strain of 0.005. Early failures shown in the tests at 38% RH and 67% RH, resulted from defects in sample preparation. It is worth noting that defects can cause premature failure. Never-the-less the ultimate breaking strains are far in excess of the yield point strain of 0.005 in each case.

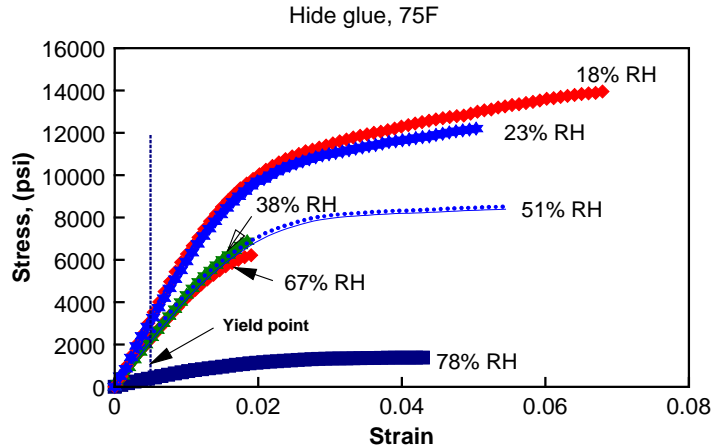

Figure 7 shows the tensile stress-strain tests for hide glue at different RH levels. Note that at very low RH levels the material is still ductile and not brittle. At high humidity levels hide glue loses strength. The initial yield point, the limit of elastic behavior, used for all of the plots is indicated by the arrow, at a strain 0.005.

Figure 8 shows the dimensional response of hide glue to both large and intermediate changes in relative humidity. The intermediate RH ranges are as with the case for the cotton wood still fairly large. Figure 8 also shows the allowable RH fluctuations for hide glue if the yield point of 0.005 is used as the criterion for environmental RH limits. These fluctuations range between 30% RH and 60% RH as compared to the guidelines recommendation of 37% RH and 53% RH. Also as with wood the allowable RH range when using the yield point of 0.005 is considerably larger than the allowable RH range under the current Smithsonian guidelines. As with the cotton wood, the wider RH ranges are still within the elastic region of the glue and it will take significantly wider ranges to cause the material to break.

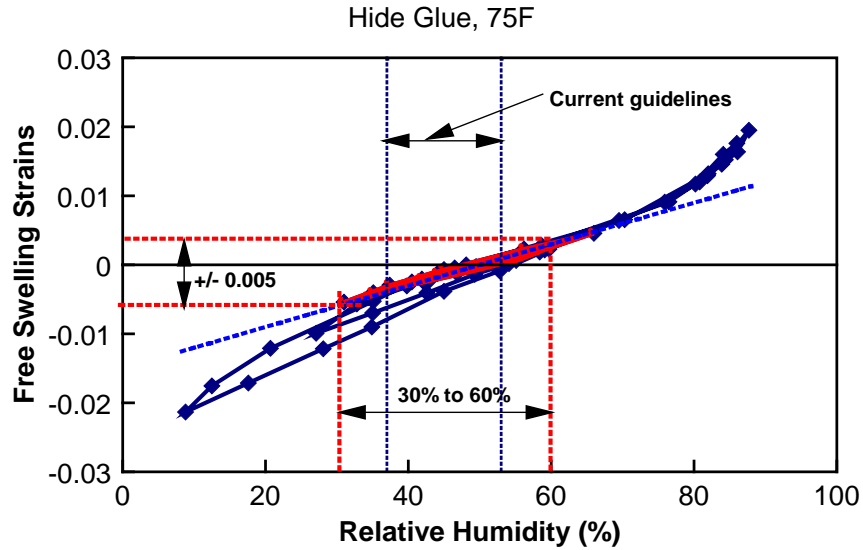

Figure 8 shows the allowable RH fluctuations for hide glue if the yield point of 0.005 is used as a criterion for environmental RH limits. These fluctuations range between 30% RH and 60% RH as compared to the guidelines recommendation of 37% RH and 53% RH.

Ivory

When discussing environmental control, one of the materials that generate the most controversy is ivory. The ivory used in these experiments was from a walrus tusk but quite similar to ivory from other species. In fact, ivory is somewhat less responsive than most woods. Figure 9 shows the tensile stress-strain tests for walrus tusk (ivory). To demonstrate its durability, this material was cycled reversibly for over 5000 cycles within the yield range. The plots shown are cycle 2109 of over 5000 cycles and the full test to failure. That the cycling of the ivory was reversible with no plastic (permanent) deformation indicated that all cycling tests were conducted below the yield point. The yield point for the ivory is indicated by the arrow at a strain 0.005. In order to cause failure the material had to be extended to a strain level of about 0.0095, almost twice the yield strain. The sample tested here was cut through the center from one side of the tusk to the other which is the weakest and most dimensionally responsive direction.

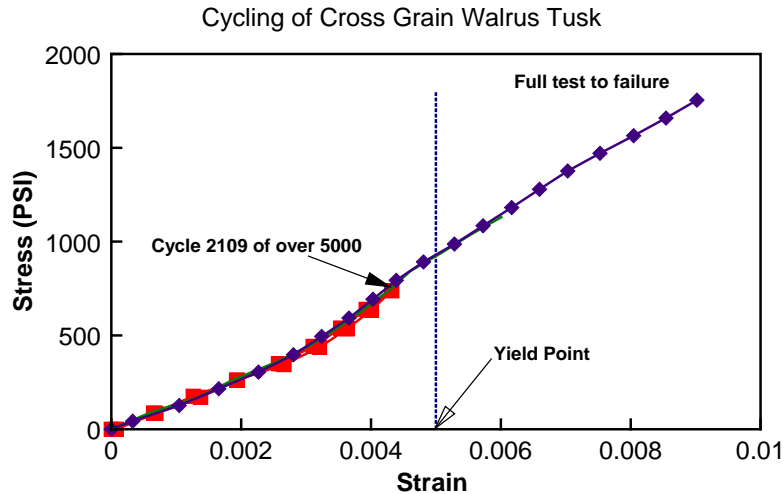

Figure 9 shows the tensile stress-strain tests for walrus tusk (ivory) at 48% RH and 74° F. This material was cycled over 5000 cycles within the yield range. The plots shown are cycles 2109 and the full test to failure. The yield points used for all of the plots is indicated by the arrow at a strain 0.005.

Figure 10 shows the dimensional response of walrus tusk to both intermediate and large changes in relative humidity. The intermediate RH ranges are fairly large. Figure 10 also shows the allowable RH fluctuations for the walrus tusk if the yield point of 0.005 is used as the criterion for environmental RH limits. These fluctuations range between 27% RH and 68% RH as compared to the guidelines recommendation of 37% RH and 53% RH.

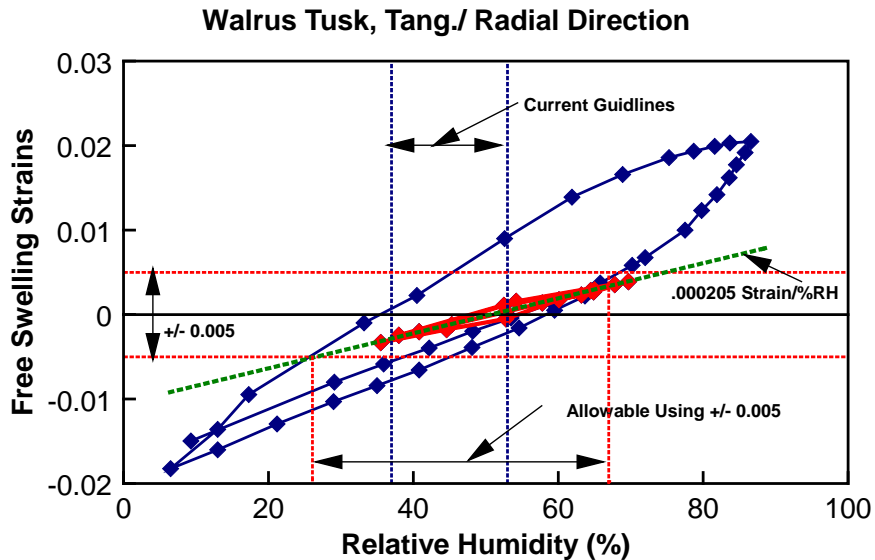

Figure 10 shows the allowable RH fluctuations for walrus tusk (ivory) if the yield point of 0.005 is used as the criterion for environmental RH limits. These fluctuations range between 27% RH and 68% RH as compared to the guidelines recommendation of 37% RH and 53% RH.

Reassessing the Some of the Initial Assumptions and Criteria

Up to this point in this discussion it was assumed that the yield point was a strain 0.005 and that the initial stress for the material zero. In doing so it is possible to show that the allowable RH fluctuations for the materials exceed the museum guideline by a considerable amount. If the actual failure strain of the materials had been used, then the allowable fluctuations would have been even greater. Clearly under selected the criteria there is a large margin of safety in the 37% to 53% RH guidelines.

Actually the magnitude of the yield strains can and does depend to a considerable degree on the environmental history of the material. Cultural materials “strain hardens” in much the same way as steels. That is, if they are stretched beyond their initial yield point and then unloaded (relaxed) they will exhibit plastic deformation (permanent deformation) and be set permanently to a different and higher yield point. Figures 11 and 12 show the unload compliance tensile tests of American mahogany and hide glue. Both of these materials strain harden and develop higher yield strains meaning there is an expansion of the elastic or reversible region of the material.

When unloaded completely and the stress is eliminated, the amount of plastic deformation can be determined by the distance between the original start of the test and the point where the stress returns to zero. In other words the material has “re-initialized” to a point of no stress but with

some plastic deformation. From the perspective of the changes in the environment, it will require RH changes considerably larger than the current Smithsonian guidelines to cause this.

Any object made more than 70 years ago, prior to the use of major HVAC systems in museums, has experienced significant changes in both temperature and relative humidity. So much so that there is a very high probability that environmental changes were sufficient to cause strains in excess of the initial yield points. This can also be said for all materials that to this day exist outside of controlled environments. In such cases the materials all experienced strain hardening in either tension or compression. In restrained woods when the humidity gets very high, this process is called “compression set” because of the plastic deformation.

The point is that the hardened yield strains are highly likely to be found in the materials of older cultural objects and are always larger than the initial yield point of 0.005. This has significant implications.

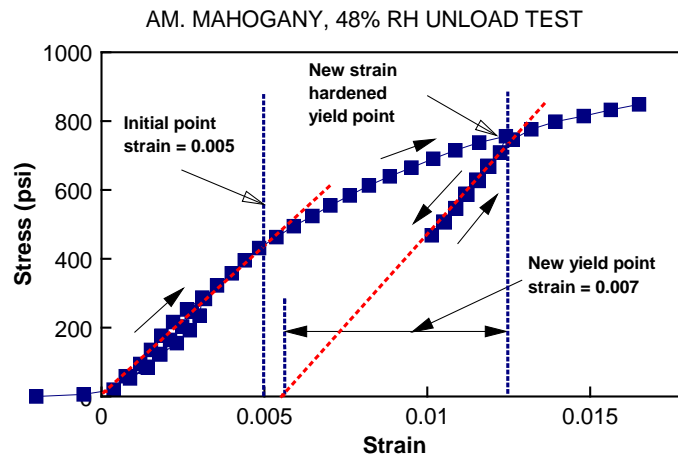

Figure 11, the stress strain test of a sample of American mahogany cut in the tangential direction. This material “strain hardens”, meaning with excessive extension (strain) it develops a larger elastic region but loses the plastic region.

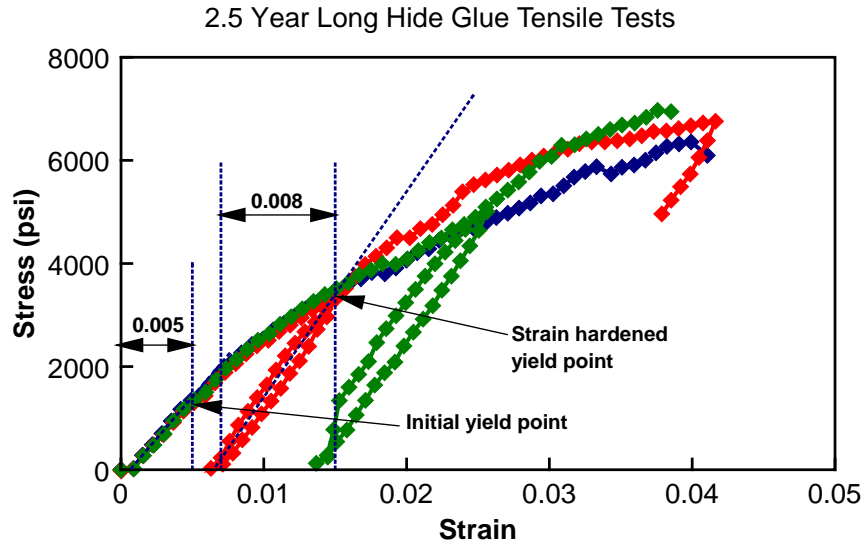

Figure 12, True equilibrium, load-unload compliance, stress strain test of three samples of hide glue at 50% RH and 74° F. This particular test illustrates strain hardening and development of new and larger yield strains of hide glue when loaded beyond the initial yield point.

When cultural materials strain harden and the elastic region increases with higher yield points the allowable fluctuations in RH increase. For example if the hide glue illustrated in Fig. 12 had strain hardened to the point where the yield point was 0.008 instead of 0.005 then the allowable RH fluctuations would increase to a range from 28% to 68% as shown in Fig. 13.

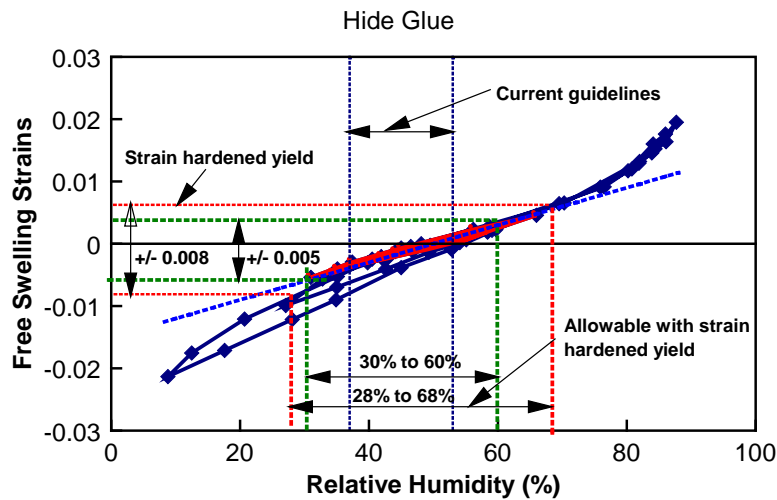

Figure 13 shows the effect of strain hardening on the allowable RH range for hide glue. Now the allowable RH range has increased to between 28% and 68%.

There is one other critical assumption that now needs to be addressed. That assumption is that the initial stress in the materials is zero. Let's suppose that a material such as the hide glue shown in Fig 14 has an initial strain of 0.005 and stress of 1255 psi at 45% RH and 72° F. Since it is already restrained and loaded, any lowering of the relative humidity will increase the mechanical strains and increase the stress.

Lowering the relative humidity from 45% to 28% increases the strain an additional 0.008, to 0.013, where the stress is approximately 3000 psi. It's possible to illustrate this on the same stress strain plot because it has already been shown (Fig. 7) that while there is some, there are no substantial changes in the mechanical properties with respect to changes in RH in the region under discussion.

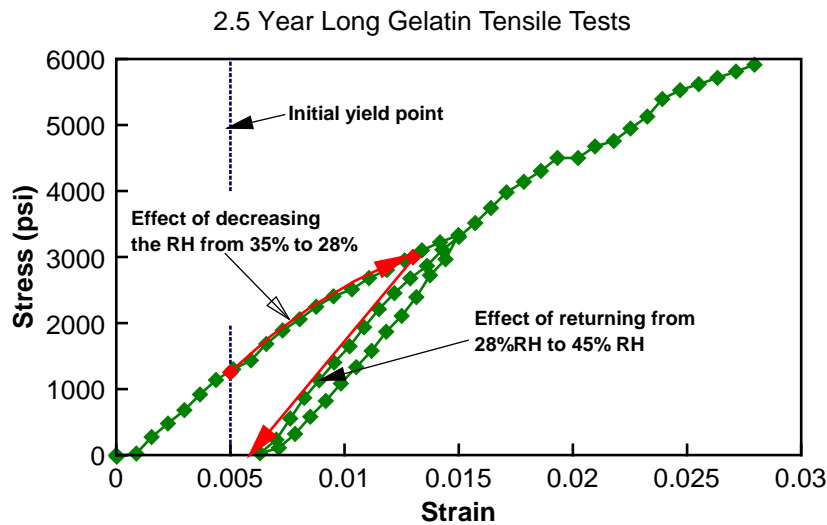

Figure 14 shows how RH excursions are able to reinitialize existing stress levels to near zero values. This is a result of both plastic deformation and strain hardening. The new slope of the modulus is typically a bit higher than the original initial modulus.

Upon returning to the original RH level of 45% one observes that the stress drops to zero as seen in Fig. 14. For restrained materials, any significant excursion from one RH level to another can alter (increase) the yield point. If the specimen is already stressed (loaded), the excursion can also reinitialize the stress level when the RH returns to its original setting.

Considering that nearly all materials found in cultural institutions have experienced RH excursion much greater than the “recommended guidelines” they have to one degree or another actually initialized themselves to the average RH settings of their current environments. This

cannot be prevented. Accordingly assuming that the initial stress is zero in this discussion is not unreasonable.

On the other hand there are times where the materials remain under fairly high stress and it is useful to explore that condition. Figure 15 shows the stress levels developed in samples of American mahogany, cotton wood (also European poplar), and white oak when restrained and desiccated. The samples are all tangentially cut. The sample desiccated from 80% RH to 28% RH follows the same path when decreasing and increasing the relative humidity. This indicates that the wood is acting in a full elastic behavior and that the yield point is considerably higher than the estimated 0.005. The samples desiccated from 55% RH to 30% RH are also acting in a completely elastic manner. None of the samples failed in these tests. Even with very high existing stresses, restrained woods can safely fluctuate in wide RH bands. From about 60% RH to 10% RH the process is completely elastic (reversible). This indicates that the initial yield point, estimated at 0.005, is very conservative and considerably higher. **This behavior also falls within the requirement that there is neither permanent deformation nor failure.**

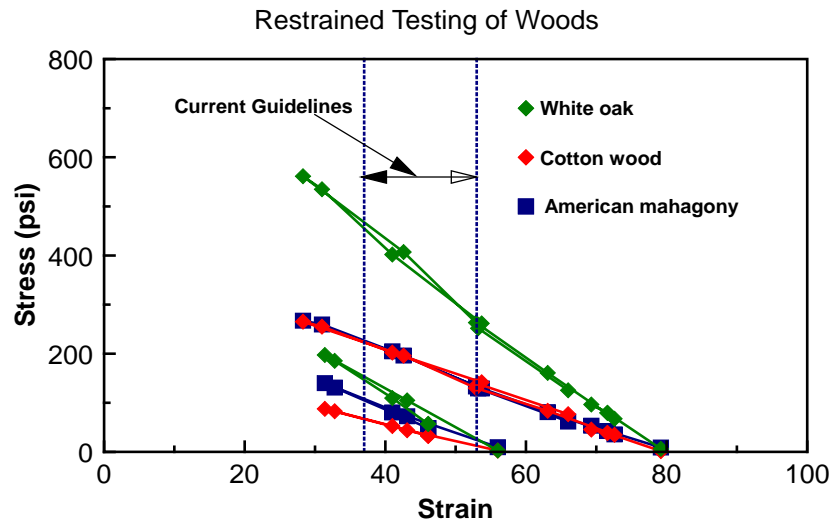

Figure 15 shows the stress levels developed in samples of American mahogany, cotton wood (European poplar), and white oak restrained and desiccated. The samples are all tangentially cut. The sample desiccated from 80% RH to 30% RH and back follows nearly the same path when decreasing and increasing the relative humidity. This indicates that the wood is acting in a full elastic behavior. This indicates that the actual yield point is considerably higher than the estimated 0.005.

Later in this paper we will examine those cases where there is existing stress in the materials.

Examples of Other Materials

Some of the materials found in cultural institutions can truly be considered brittle. This means that there is very little, if any capacity for plastic deformation. Certainly glass and ceramics fall under this category. In these cases the materials often act as if they are completely elastic, exhibiting no permanent deformation. One other feature of these types of materials is that they will break with very little deformation or in terms of mechanics the strain to failure is extremely small.

Some of these materials include gessoes and some brittle paints such as old (and even some new) oil paints and degraded materials such as deteriorated paper. While it is impossible to look at every material found in collections at this time, few have greater dimensional responses than woods, glues, and ivory. Those materials that are somewhat responsive such as paper, parchment, and textiles tend to be exhibited in such a manner that there is little restraint and they are buffered by framing techniques and exhibition cases.

In this section we will discuss gesso and oil paints. Paints such as the acrylics are extremely flexible in normal room temperature environments. Enamels can in many respects fall under the category of oil paints. The alkyd paints can also be placed in the category of oils, not because they are the same chemically but because they have similar if not better properties than the oils with respect to relative humidity. Paints such as the butyrate and nitrate dopes used on the fabrics of early aircraft are extremely durable as evidenced by their ability to withstand outdoor environments for considerable amounts of time. The most serious problem with oil, alkyd and acrylic paints is their susceptibility to damage by low temperature and will be discussed in some detail in the section on temperature effects.

Gessoes

Traditional gesso is a mixture of water, rabbit skin (hide) glue and an inert materials such as calcium sulfate (gypsum). Other inert materials used were calcium carbonate (chalk) and ground marble dust. In more recent times titanium dioxide pigment has been used. Traditionally gesso was applied as a solution onto wood panels prior to painting. When dry it provided a smooth absorbent surface. This was particularly effective when painting in egg tempera. In some of the traditional recipes for gesso molasses was added to improve its flexibility.

There were some gessoes used in canvas painting but the material proved to be too brittle. Other types of gessoes called boles were used to prepare frames for gilding. The inert material used in gilding was clay called gilder's clay but rabbit skin glue was still used. While clay can be somewhat responsive to moisture the most active material was still the hide glue.

Both the dimensional response and the mechanical properties of gesso depend on the strength of the hide glue used and the ratio of glue to inert materials. That ratio is usually described in terms of the percent pigment volume ration or PVC. The higher the volume of inert material (or PVC)

the more brittle the gesso and less the responsive to moisture with respect to dimensional changes. In general stiff and brittle gessos will have little dimensional response to changes in relative humidity. The mechanical properties will change significantly however when the RH levels are changed. (Mecklenburg, 1992)

Figures 16 and 17 show the mechanical properties of gessos made with hide glue and calcium carbonate. Gesso 10A, shown in Fig. 16 shows replicated tests of a gesso at three different levels of RH, 16%, 49% and 96%. The pigment volume concentration of the gesso is 71%. From 49% RH to 16% RH the mechanical properties are fairly similar but as is shown the strain to failure is very close to our assigned yield strain when the RH is at 16%. At 96% RH, the strength of the gesso is greatly diminished but it remains quite flexible. At moderate to very low humidity levels gesso can be considered to be nearly brittle.

Figure 17 shows the mechanical tests gesso 10B at three different environments, 17% RH, 55% RH, and 84% RH. The pigment volume concentration of this gesso is 71% but 16% molasses (by weight) was added to act as a traditional plasticizer. The addition of the molasses has several effects. The gesso is now weaker than the gesso without the molasses. It is more responsive to the changes in relative humidity. For example the samples tested at 17% RH are much stiffer than gesso 10A and fails at a strain of 0.004 which is below the assigned yield strain. At the mid range relative humidity levels, the samples are more flexible and the strain to failure is greater than gesso 10A.

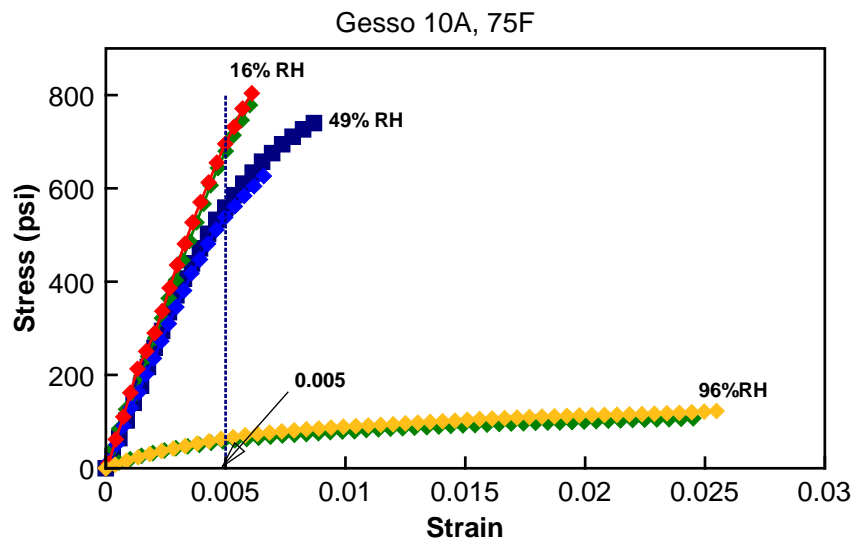

Figure 16 shows the stress strain tests for replicated samples of gesso 10A at three different environments. The gesso was made with hide glue with gram strength of 251 and calcium carbonate. The PVC of the gesso was 71%. (Data courtesy of Dr. Laura Fuster Lopez)

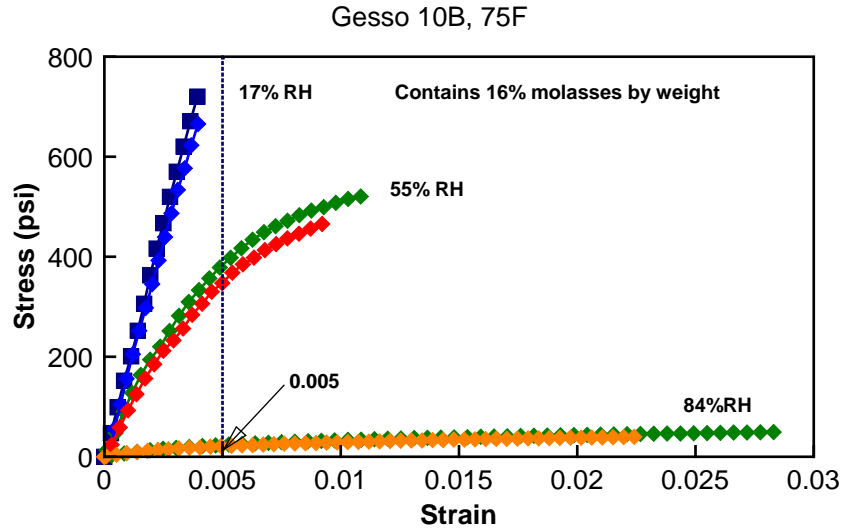

Figure 17 shows the stress strain tests for replicated samples of gesso 10B at three different environments. The gesso was made with hide glue with gram strength of 251 and calcium carbonate. The PVC of the gesso was 71%. Gesso 10B has as added 16% (by weight) molasses. (Data courtesy of Dr. Laura Fuster Lopez)

At the higher RH level of 84%, gesso 10B has nearly lost all of its strength. At even higher humidity around 90% this material will loose all strength. Clearly one needs to stay in the mid range RH for this material.

It is now necessary to determine the allowable humidity ranges. Figure 18 shows the allowable RH fluctuations for gessos 10A and 10B if the yield point of 0.005 is used as the criterion for environmental RH limits. These fluctuations range between 18% RH and 73% RH as compared to the guidelines recommendation of 37% RH and 53% RH. This wide allowable range of RH occurs simply because the dimensional response to changes in relative humidity is so low.

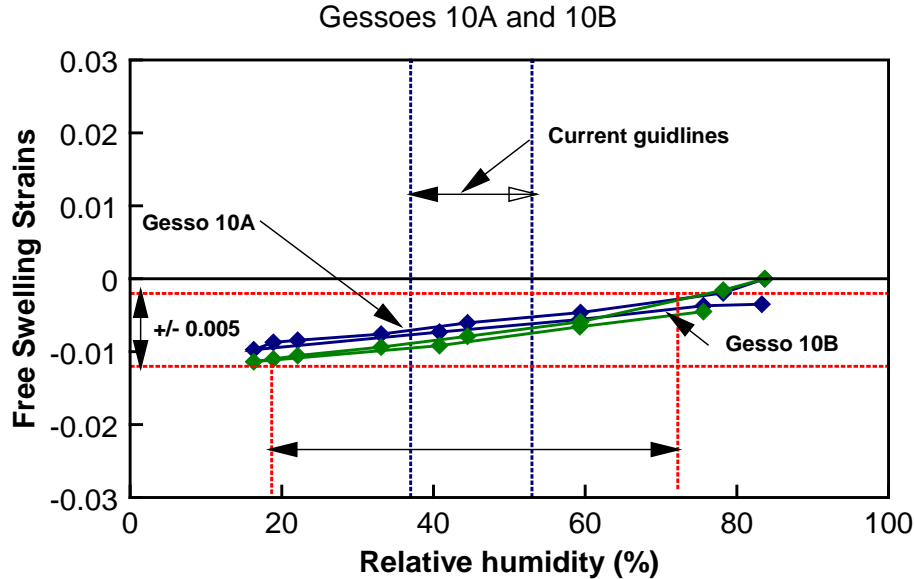

Figure 18 shows the allowable RH fluctuations for gessos 10A and 10B if the yield point of 0.005 is used as the criterion for environmental RH limits. These fluctuations range between 18% RH and 73% RH as compared to the guidelines recommendation of 37% RH and 53% RH. Gessos 10A and 10B were made with the hide glue and calcium carbonate. The PVC was 71%. Gesso 10B has as added 16% (by weight) molasses. (Data courtesy of Dr. Laura Fuster Lopez)

As before, it was assumed that the initial stress at the set point RH of 47% was zero. This might be true for panel paintings that had been subjected to large environmental swings in their history but what about newer paintings and those that have a history of moderate environments.

Suppose that we take different samples of gesso, adding to the ones already discussed, restrain them and systematically desiccate them. In this way it is possible to actually measure the stresses developed but also illustrate the RH ranges that are actually possible with out causing the specimens to break.

Figure 19 shows the result of conducting such a test. The gesso samples used are described as follows.

- Gesso 10A, W&H hide glue, calcium carbonate, PVC = 71%
- Gesso 10B, W&H hide glue, calcium carbonate, PVC = 71%, 16% Molasses
- Gesso 11A, Bjorn hide glue, calcium carbonate, PVC = 75%
- Gesso 11B, Bjorn hide glue, calcium carbonate, PVC = 75%, 16% Molasses
- Gesso 12A, Bjorn hide glue, calcium carbonate, PVC = 69%
- Gesso 12B, Bjorn hide glue, calcium carbonate, PVC = 69%, 16% Molasses

The gesso samples were all restrained at 70% RH and desiccated incrementally. At each increment of RH they reached equilibrium and the stress levels were recorded. As desiccation proceeded the stress increased in the gesso samples. At about 18% RH the test is reversed in that the humidity is now increased. As the humidity increases the stress lowers. At 45% RH, our museum set point, all of the gesso samples already have significant stress levels. So our initial assumption that the stresses need to be zero is not necessarily required. What is extremely significant here is that the downward stress paths are nearly identical to the upward stress paths. This means that the gesso samples tested are all exhibiting nearly full elastic behavior without any plastic deformation. This in turn means that the original assumption that the initial yield strain for the gesso was 0.005 was inaccurate, it is actually much higher.

It is also of significance that none of the specimens broke during this test even though the relative humidity range was from 70% RH to 18%, which is clearly beyond the current museum environment guidelines. This form of restrained testing will be examined with other materials as this discussion proceeds.

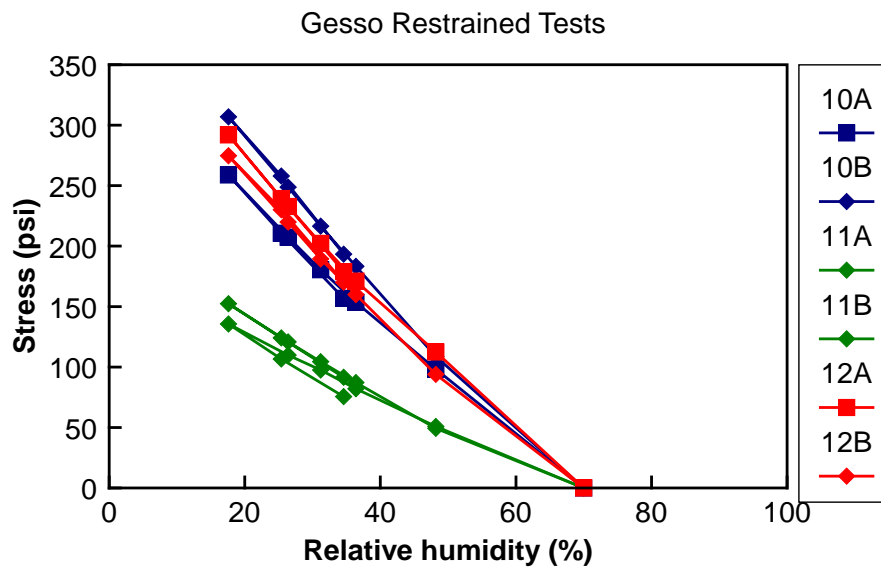

Figure 19 shows the test results of 6 different gesso samples when restrained and desiccated. In this test, stress increases as the humidity is lowered. Samples 11A and 11B, the gesses with the highest PVC (75%) have the lowest hide glue content and are the least responsive to RH. (Data courtesy of Dr. Laura Fuster Lopez)

There can be no question that in the early panel paintings the gesso layer was the weak link in the structure. In the 15th century where both egg tempera and oil paints were used, a typical wood panel painting construction was multilayered. The primary support was wood, then a layer of hide glue, possibly a layer of fabric, a gesso layer and then the colored design layers and possibly gilding. Figures 20 – 23 show both tempera and oil panel paintings and details of paintings from

the 15th century. In both cases cracks appear in the design layers. What is of interest is these cracks originated in the gesso layers of both paintings and that the cracks are primarily perpendicular to the grain of the wood panels.

This means that the wood panel and gesso are responding independently to the environmental changes in moisture. It has already been shown that the wood does not significantly change dimensionally in the direction parallel to the grain and in this case it is acting as a restraint to the dimensional change in the gesso layers of these panel paintings. Since the gesso layers are restrained in direction parallel to the grain of the wood and have been subjected to fairly large and uncontrolled changes in ambient relative humidity, the gesso cracks. These paintings are excellent examples of how one material in the painting can restrain another. On the other hand the wood does move with moisture change in the direction perpendicular to the grain of the wood and when desiccation occurs, the shrinking of the wood relieves the stresses and strains in the contracting gesso layers limiting cracking parallel to the grain of the wood.



Figure 20, Gentile da Fabriano, Marchigian, c. 1370-1427, **Madonna and Child Enthroned**, c. 1420, Tempera on panel, 37 11/16 in. x 22 1/4 in. (95.7 x 56.5 cm), Samuel H. Kress Collection, 1939.1.255. (Courtesy of the National Gallery of Art, Washington, D.C.)



Figure 21, detail, showing cracks largely perpendicular to the grain of the wood support. Gentile da Fabriano, Marchigian, c. 1370-1427, **Madonna and Child Enthroned**, c 1420, Tempera on panel, 37 11/16 in. x 22 ¼ in. (95.7 x 56.5 cm), Samuel H. Kress Collection, 1939.1.255. (Courtesy of the National Gallery of Art, Washington, D.C.)

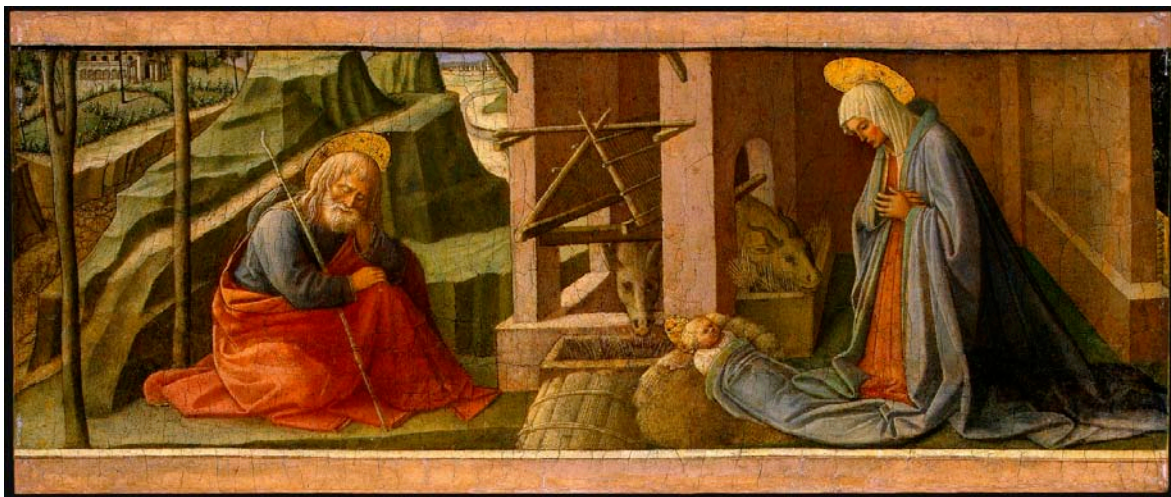

Figure 22, Fra Lippo Lippi and workshop, Florentine, c. 1406-1469, **The Nativity**, probably c 1445, oil and tempera (?) on panel, 9 1/8 in. x 21 ¾ in. (23.2 x 55.3 cm), Samuel H. Kress Collection, 1939.1.279. (Courtesy of the National Gallery of Art, Washington, D.C.)



Figure 23, detail showing cracks perpendicular to the grain of the wool panel. Fra Lippo Lippi and workshop, Florentine, c. 1406-1469, **The Nativity**, probably c 1445, oil and tempera (?) on panel, 9 1/8 in. x 21 3/4 in. (23.2 x 55.3 cm), Samuel H. Kress Collection, 1939.1.279. (Courtesy of the National Gallery of Art, Washington, D.C.)

There are other observations to be made. One is that there is little cracking in the paint layers independent of the gesso layers. Egg tempera forms a very tough film resistant to both moisture and cleaning solvents. Seemingly in the Fra Lippo Lippi (Figs. 22-23) paintings, the oils are demonstrating a similar toughness. Finally the question that needs asking is: what were the environmental changes that occurred to cause such cracking in these paintings? From the research above the change had to have been greater than from 70% RH to 20% RH and it probably was more in the order of 85% to 25%.

Oil Paints

Oil paints are complex in that the different pigments cause paints to dry having very different RH-related mechanical and dimensional properties. Some pigments when added to drying oils form very durable paints while others such as the earth color pigments form weak paints. In addition oil paints made with the white pigments, basic lead carbonate, titanium dioxide, and zinc oxide are very dimensionally stable. On the other hand those paints made with the earth colors, such as ochre, umber, and Sienna get fairly responsive when the relative humidity exceeds 60%. This is a result of the swelling of natural clays found in these pigments. It will be useful to examine some of these paints

Figure 24 show the stress strain results for different paints after drying for at least 12 years in a controlled environment of 40%-50% RH and 23° C. Because of hydrolysis, the paints made with the earth colors develop very little strength and stiffness even after 12.25 years of drying. The paints made with titanium white and basic lead carbonate have nearly the same modulus (initial stiffness) but the titanium white has little strength and its extension barely reaches the yield point of 0.005 (0.5% elongation). The titanium white can be considered a weak and brittle paint. The paint made with the zinc oxide has developed a very high modulus and while it has developed a high strength, it is a very strong, brittle paint having a breaking strain of only 0.003 (0.3% elongation). The paint made with malachite is included to illustrate the effects of pigments containing copper compounds.

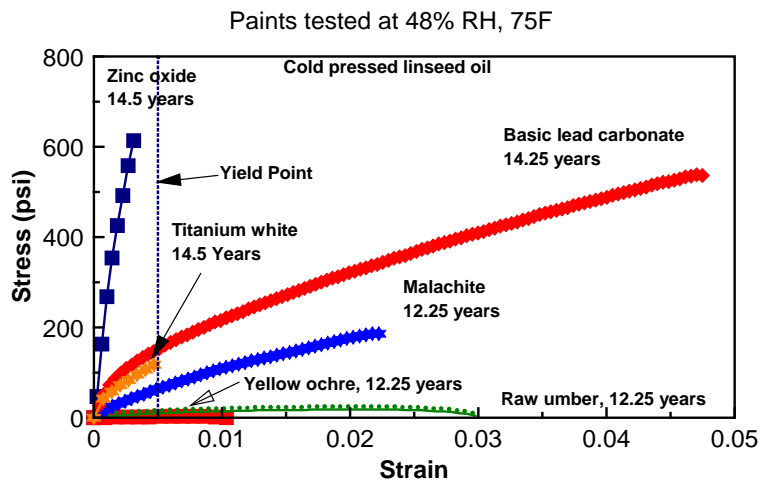

Figure 24, the results of stress strain tests conducted of paints made with different pigments. As can be seen the different pigments have a dramatic effect on the mechanical properties of oil paints. It must be noted that pigment volume concentrations can also have similar effects but these data are a result of the different pigments.

It is necessary to understand that while the strength of paint is important its ability to elongate (its flexibility) is of far greater importance. It doesn't take a great deal of force to crack thin paint films even though they have relatively high strength. It would be useful to look at some oil paints made with different pigments.

Figure 25 shows the tensile stress-strain tests of a paint made by grinding basic lead carbonate in cold pressed linseed oil. This paint would be typical of a paint made several hundred years ago, that is without the addition of any modern driers, stabilizers, or inert bulking material. As shown in this figure, the paint is getting stronger (greater stress at break) as the time of drying continues, and there is a modest reduction in the strain (elongation) at the point of failure. The strains to failure in this paint are fairly high and it is still quite flexible after 14.25 years of

drying. One point of interest is that the paint shows a continual increase in strength over this time period. This means that whatever chemical processes that affect the mechanical properties of this paint are still continuing.

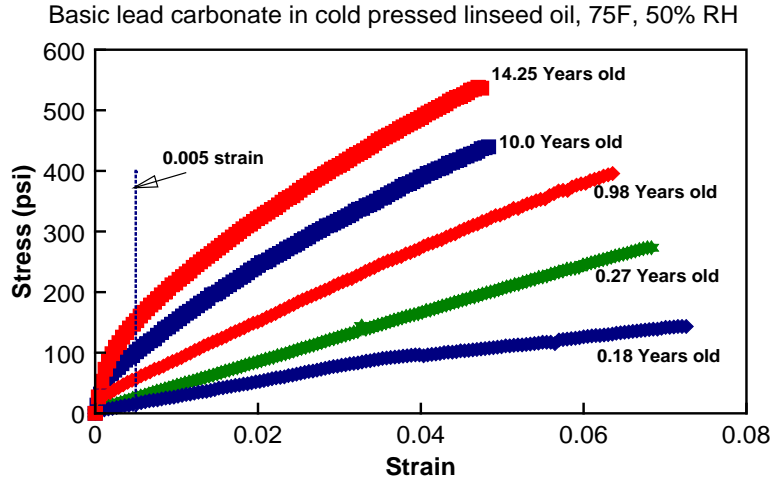

Figure 25 shows the stress versus strain plots of basic lead carbonate (lead white) paint made with cold pressed linseed oil at different ages. Even after 14.25 years, the paint is still gaining in stiffness and strength. These plots indicate that the processes that cause the increase in stiffness and strength show little indication of slowing down.

Figure 26 shows the tensile stress-strain tests for white lead (basic lead carbonate) ground in cold pressed linseed oil at different RH levels. Note that at very low RH levels the material is still ductile and not brittle. At high humidity levels the paint loses some strength but increases in flexibility. The yield point used for all of the plots is indicated by the arrow at a strain 0.005. As with other materials paint also strain harden. White lead oil paint is a very durable paint and this shows in actual paintings subjected to very adverse environmental changes.

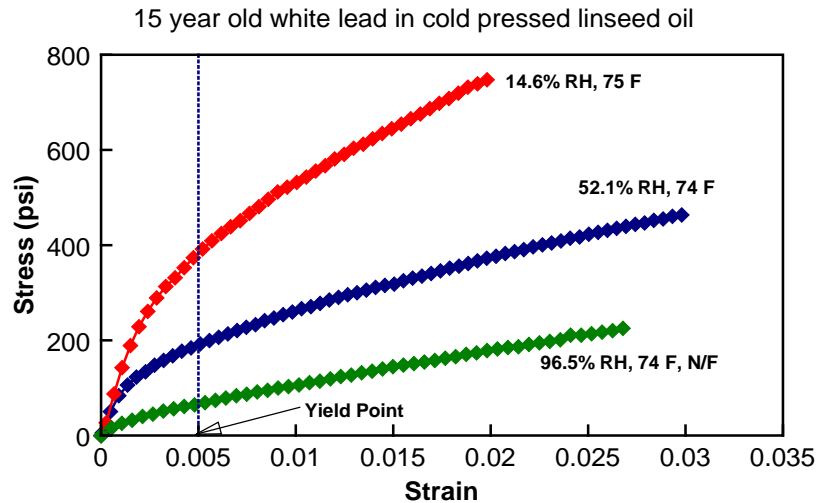

Figure 26 shows the tensile stress-strain tests for white lead (basic lead carbonate) ground in cold pressed linseed oil at different RH levels. Note that at very low RH levels the material is still ductile and not brittle. At high humidity levels the paint loses some strength but increases in flexibility. The yield points used for all of the plots is indicated by the arrow at a strain 0.005. As with other materials paint also strain harden. (N/F means not to failure)

Figure 27 shows the allowable RH fluctuations for lead white oil paint if the yield point of 0.005 is used as the criterion for environmental RH limits. These fluctuations range between 0% RH and 100% RH as compared to the guidelines recommendation of 37% RH and 53% RH. It is the good mechanical properties and the low dimensional response to moisture that explains the durability of lead white oil paint. When the lead based paints were replaced with other whites due to toxicity issues, the commercial replacement whites included oil paints made with mixtures of titanium dioxide and zinc oxide or zinc oxide alone. Both of these commercial oil paints exhibit brittleness and low dimensional response.

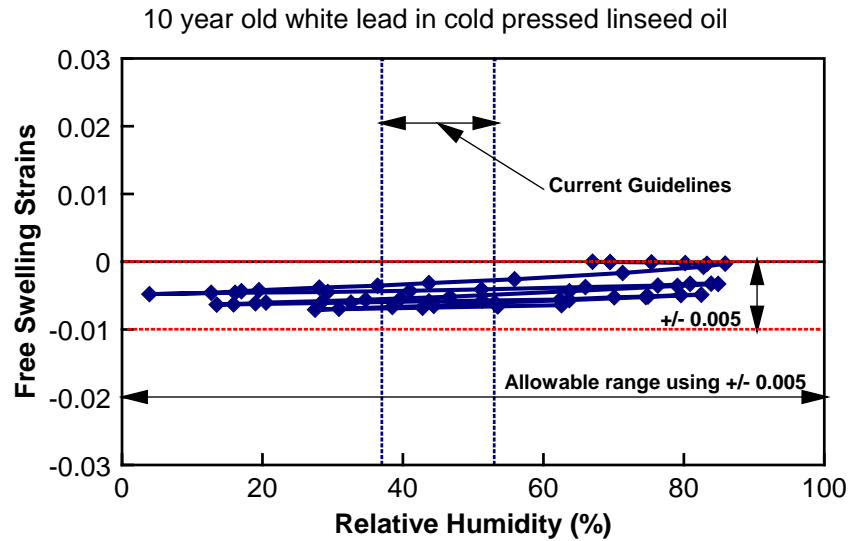

Figure 27 shows the allowable RH fluctuations for lead white oil paint if the yield point of 0.005 is used as the criterion for environmental RH limits. These fluctuations range between 0% RH and 100% RH as compared to the guidelines recommendation of 37% RH and 53% RH.

Looking at Extremely Brittle Paints

If one examines Fig. 24 closely it is easily seen that oil paints made with zinc oxide or titanium dioxide are extremely brittle. So much so that the strains at failure are either at the yield point (titanium white) or below the yield point (zinc white). In these cases it might appear that these materials could be considered limiting factors when establishing RH boundaries for museums. However oil paints made with either titanium or zinc have extremely low dimensional response rates to moisture. Figures 28 and 29 illustrate this. In the case of the titanium white paint if one uses **strain limits of +/- 0.002 instead of the yield strain of +/- 0.005** there would still be a large allowable RH range between 28% RH and 66% RH as shown in Fig. 28.

In the case of the oil paint made with the zinc oxide the allowable range would be from 17%RH to 63% RH if the allowable strain criterion of only +/- 0.002 were used instead of the +/- 0.005 as shown in Fig. 29.

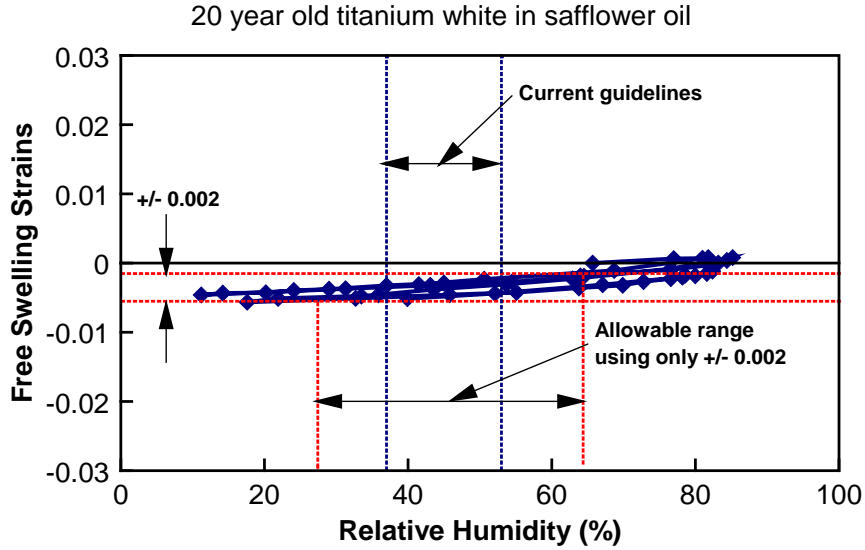

Figure 28 shows the allowable RH fluctuations for titanium white oil paint if the strain criterion of only ± 0.002 and not the yield point of ± 0.005 are used. These allowable fluctuations range between 28% RH and 66% RH as compared to the guidelines recommendation of 37% RH and 53% RH.

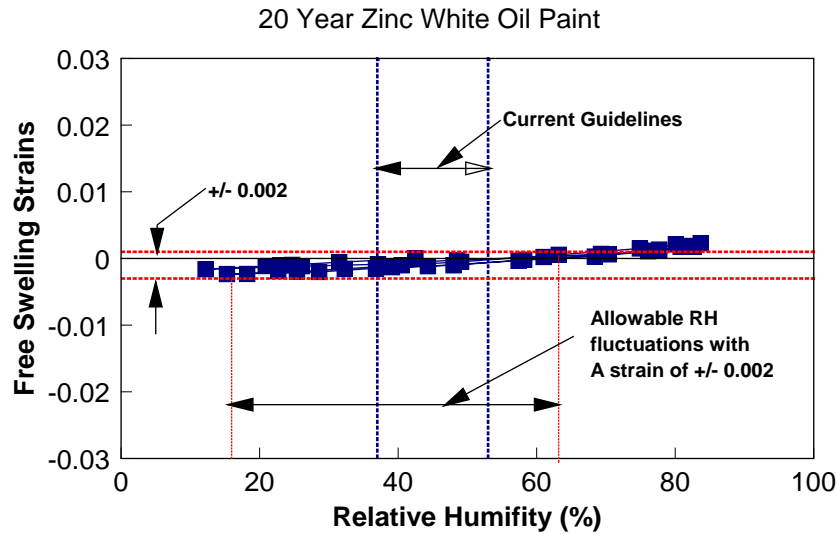

Figure 29, the swelling response to large changes in relative humidity of 20 year old zinc white paint ground in alkali refined linseed oil. As with the other white paints shown, there is very little dimensional response to changes in RH.

Figure 30 shows the mechanical test results of paints made with the pigments raw umber and yellow ochre at 1.25 years and 12.25 years. While the white lead paint in cold pressed linseed oil continues to stiffen over the years (Fig. 25), these two paints (and oil paints made with burnt umber) show an increase in stiffness up to about 1.25 years and at some point thereafter the paints proceed to loose that early stiffness. At 12.25 years the paints are true films but they are extremely weak and they have lost some of their ability to elongate. The reason this is happening is because these paints are becoming hydrolyzed by moisture in the air. (Mecklenburg et al, 2005 and Tumosa et al, 2005)

Hydrolysis is occurring very early in these paint's drying history and in spite of the fact that these paints have been maintained in a very benign environment of 23° C and 40%-55% RH.

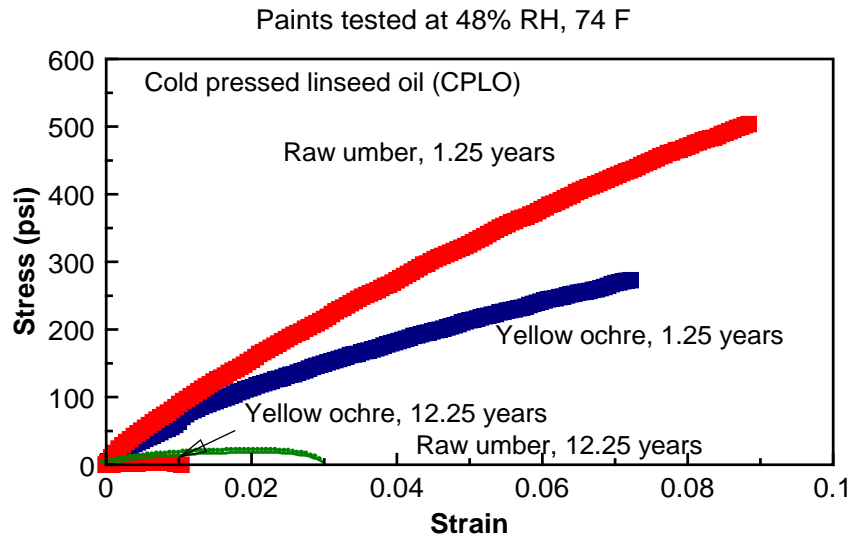

Figure 30 shows the mechanical test results of paints made with the pigments raw umber and yellow ochre at 1.25 years and 12.25 years. Where the white lead paint in cold pressed linseed oil continue to stiffen over the years (Fig. 25), these two paints show an increase in stiffness up to around 1.25 years and at some point shortly thereafter the paints proceed to loose that early stiffness. At 12.25 years the paints are true films but they are extremely weak and they have lost their ability to elongate. This is occurring because these paints are becoming hydrolyzed by moisture in the air

The paints made with the earth colors tend to be low in strength at 50% RH and higher humidity, above 70%, seriously degrades their strength further. Because these paints are weak they are easily damaged by solvents in the cleaning process. Nevertheless the paints made with the earth colors can withstand an allowable RH range of between 30% and 64% as shown in Fig. 31.

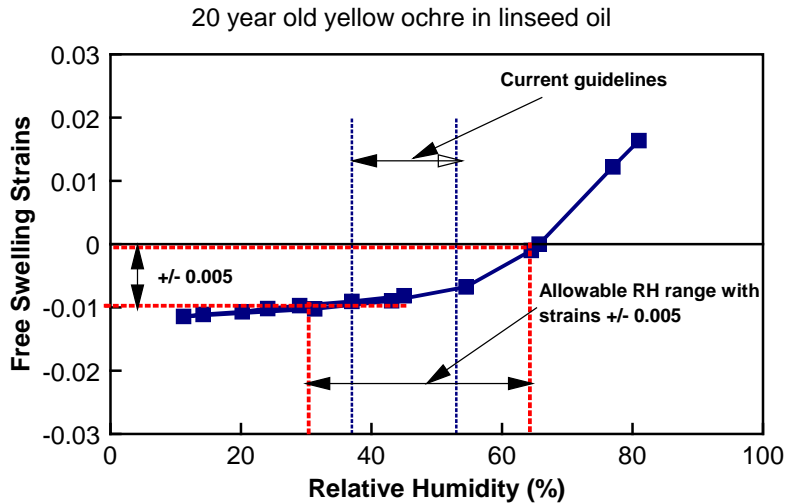

Figure 31 shows the allowable RH fluctuations for yellow ochre oil paint if using a yield point criterion of ± 0.005 is used for establishing the environmental RH limits. These allowable fluctuations range between 30% RH and 64% RH as compared to the guidelines recommendation of 37% RH and 53% RH.

Interactive Behavior in Composite Structures and the Effects of high RH

In some ways, the simplest composite structure is painted wood. The illustrations of some of the behavior of wood panel paintings shown in Figs. 20-23 demonstrate the restraint of wood on gesso. For those panel paintings having oil grounds and oil design layers the same dimensional parameters hold. That is, constraint in the direction of the grain and release of stresses and strains perpendicular to grain.

Certainly oil paintings on wood can have cracking but the real question is what was responsible, the paint or the wood? It is discernible in most cases where the paint is damaged by the wood since the cracks in the paint layer are parallel to the grain of the wood. This makes sense since the wood moves the most in a direction perpendicular to the grain. But to do so the wood has to move considerably and this requires very large changes in relative humidity.

In those cases where paint cleaves in tents parallel to the grain of the wood, excessively high humidity and restraint to the wood must have occurred. At high humidity and if restrained, the wood “compression sets” and becomes smaller than before. On drying out the wood shrinks leaving less room for the design layer cleaved and it is off in ridges.

Consider the case where there is total constraint of the support in all directions and large changes in relative humidity. Such a case is the oil painting on copper. Such total restraint is rare for there is some movement of wood even in the longitudinal direction. Copper is totally

unresponsive (dimensionally) to changes in moisture yet oil paintings on copper are some of the most durable paintings existing today as seen in the painting by Jan van Kessel in Fig. 32.

“And, as artists beginning with Leonardo da Vinci (Italian 1452-1519) suspected, paintings on copper that are well cared for are extremely durable and generally survive in excellent condition” (Bowron, 1999)

It would be expected that if oil paints are excessively responsive to moisture changes in the environment and that the copper is acting as a perfect restraint, there would be extensive damages to such paintings. There is no such damage.

Yet there is a remarkable lack of cracking on many paintings on copper. When there is cracking it is mostly fine and random since the copper support provides no dimensional bias to the paint films. Much of the mechanical damage found in paintings on copper results from the copper supports being dented or folded. Oil paintings on copper represent one of the most significant clues as to the actual durability of oil paints with respect to moisture in the environment. Figure 32 shows the remarkable state of preservation of an oil on copper.



Figure 32, Jan van Kessel, Study of Butterfly and Insects, c 1655, Oil on copper, 4 5/16 in. x 5 13/16 in. 1983.19.3 (Photo courtesy of the National Gallery of Art, Washington, D.C.)

Canvas Paintings

Canvas paintings represent some of the most complex structures in the cultural world. This is because of the widely varied materials used and their complex response to the environment. This can only be illustrated by looking at each layer individually and then superimposing the layers together. A cross-section of a traditional canvas supported oil painting is shown in Fig. 33. This assembly includes the “support” canvas, a glue size layer, an oil ground and the oil design layers. As is shown in the figure the glue size layer is almost too thin to see. This particular section was from a 19th century Italian painting.



Figure 32, the construction of a traditional canvas supported painting. This assembly includes the “support” canvas, a glue size layer, an oil ground and the oil design layers. This particular section was from a 19th century Italian painting. The green bar at the top of the picture is 0.04 in. (1mm). (The cross-section and photograph courtesy of Melvin J. Wachowiak)

Figure 34 shows a detail of the same 19th century Italian painting as shown in Fig. 33 but looking from the front. This assembly includes the “support” canvas, a glue size layer, an oil ground and the oil design layers. As is shown in this figure the glue size layer is an extremely thin film bridging the gaps in the weave of the canvas. Even though very thin this layer is still very responsive to changes in RH.



Figure 34 shows a detail of the same 19th century Italian painting shown in Fig. 33 but looking from the front. As is shown in this figure the glue size layer is an extremely thin film bridging the gaps in the weave of the canvas. Even though very thin this layer is still very responsive to changes in RH. (Photograph courtesy of Melvin J. Wachowiak)

One of the most misunderstood features of the canvas supported paintings is the support itself. Where it has been considered that the canvas of the painting is the support, in actuality it is the glue size that maintains the highest forces for most of the RH ranges. This can be illustrated by looking at the individual layers of the painting when they are restrained and subjected to changes in relative humidity. (Mecklenburg, 1982)

In addition to exploring how each layer of the painting responds to the environmental changes it is possible to determine the actual damage mechanisms that occur at different levels of relative humidity. Where it was assumed that the initial stresses in the materials were zero, that condition rarely exists in a stretched canvas painting. As will be shown the stresses in each layer vary considerably with changes in relative humidity.

For this discussion let's restrain samples of linen in both the warp and fill directions. Once restrained it is possible to see the forces that are developed in the material. In this section each of the materials examined will be of the thickness encountered in a typical painting. **It is important**

to note that the force per width of sample acting on individual materials is used since it is not practical to calculate the stresses in a linen textile. Using this strategy, it is also possible to examine the effects of the thicknesses of each of the different layers.

In building the composite painting from the support canvas up it is useful to start with the canvas. The sample of linen tested was from an Ulster #8800 canvas. It is a medium weight canvas and would be found on many easel paintings. Both the weft and fill directions were tested. An initial force was applied to the specimens at mid RH and the relative humidity was incrementally changed and the force per width recorded. This was continued for several cycles over a large range of relative humidity.

Figure 35 shows the results of such testing. Between 10% RH and 60% RH there is relatively little change in the force on either the warp or fill directions of the textile. From 60% RH on there is a gradual increase in stress and above 80% RH the force increases dramatically. When damp or wet, loose textiles shrink dramatically and when restrained the shrinkage show up as significant forces in the textile. This is the first indication that dramatic events take place in canvas paintings when the humidity gets very high. This behavior was replicated using a wide variety of different textiles by Gerry Hedley at the Canadian Conservation Institute. (Hedley, 1988)

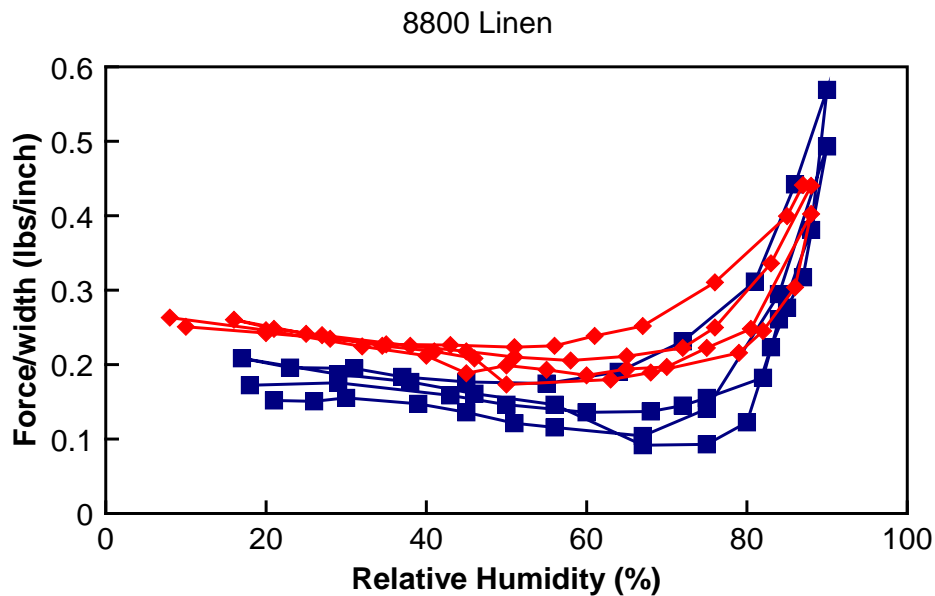

Figure 35 shows the tensile forces per width measured in individual restrained samples of the #8800 linen in the warp and fill directions with changing relative humidity. The greater forces develop when the relative humidity is above 80%.

Of all of the materials used in canvas paintings hide glue is the strongest and nearly the stiffest. It is also the one material that develops the most force when restrained and desiccated. It is because this material is both stiff (and strong) and has a high dimensional response at low humidity that it develops so much force. Figure 36 shows both the force per width (and stress) that a very thin film (0.00047 in.) of glue will develop when restrained and desiccated from 85% to 15% RH. The thickness of the film is about the same as that found as a size coating on a painting. (See Fig. 34)

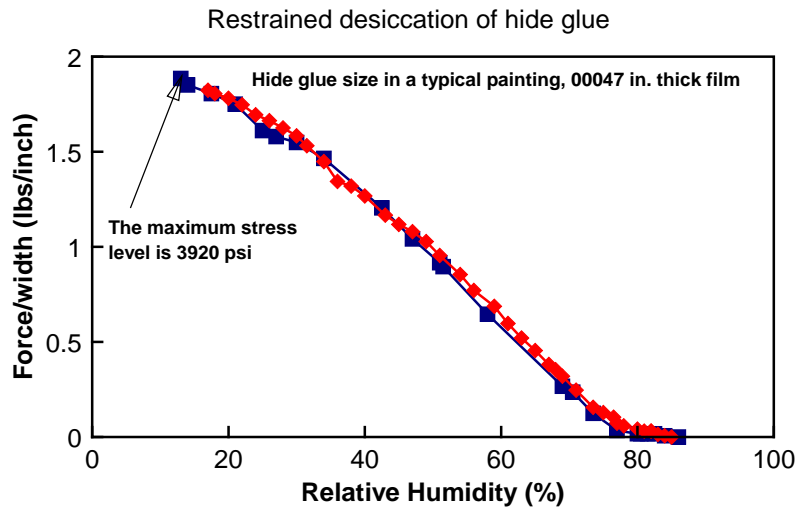

Figure 36 shows the force per width of restrained samples of hide glue when desiccated from 85% to 15% RH. The stress of the hide glue at the maximum force per width of these samples was 3920 psi. From 80% RH and above the hide glue has no strength and therefore no ability to retain the bond between the canvas and ground layers.

In general, the force per width (and stress) developed in restrained and desiccated oil paint is considerably less than the other materials found in paintings. One of the reasons is that with the exception of some of the paints made with the earth colors, the dimensional response to humidity changes is low. On the other hand while the earth colors tend to have a higher dimensional response they have relatively low stiffness. Figure 37 shows two paint samples restrained and desiccated from around 75% to 5% RH. Even with this large change in relative humidity, the forces and stresses developed are low. So the likelihood that large changes in low humidity alone can damage the oil paint layer is low. It takes a combination of materials and their individual responses to changes in humidity to cause deterioration. This can be demonstrated by superimposing all of the layers of a painting together and comparing the results with an actual painting.

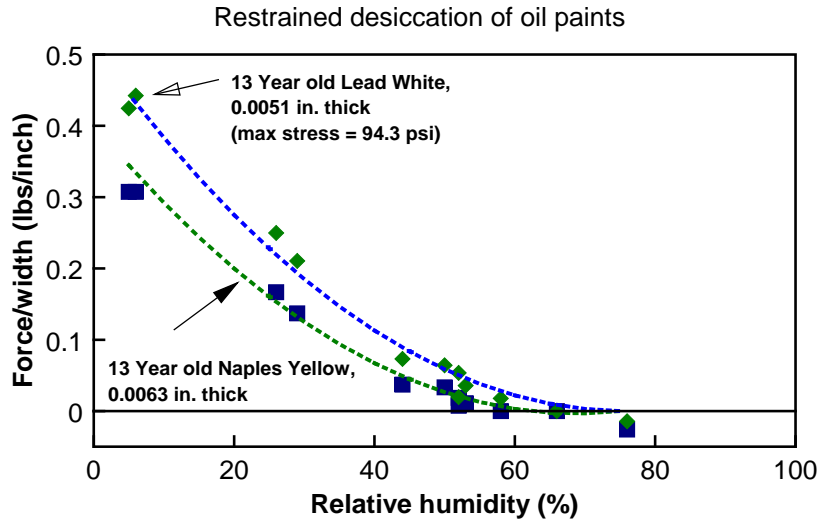

Figure 37 shows the force per width of restrained samples of lead white and Naples yellow oil paints. The stress of the white lead paint at the maximum force per width of this sample was only 94.3 psi. The force per width of the paints is considerably lower than the hide glue and a bit lower than the #8800 linen shown in Fig. 33. The thicknesses indicated for the paint samples is typical of those found in paintings.

Superposition of the different paint layers

It is possible to plot the information from Figs. 35, 36, and 37 on the same graph as shown in Fig. 38. The thickness of these films are the same shown in their respective figures and would be typical of a common painting. In this figure it is possible compare the responses of the individual layers of a canvas painting and to determine the different forces occurring at different levels of RH. For example the fabric is developing high forces only at high RH levels and staying relatively constant at humidity levels below 80%. The hide glue is developing high forces at very low RH levels but loses all strength at levels above 80%RH. Also note that the paint films are developing relatively low forces and that is only at very low levels of RH.

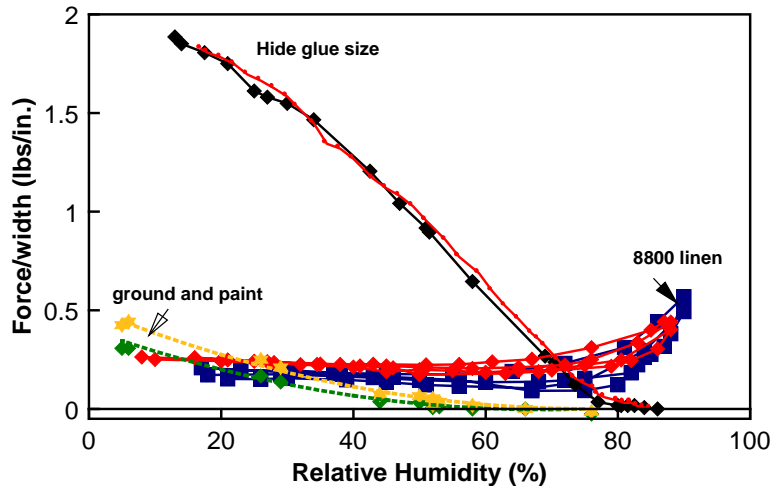

Figure 37 shows the force per width of restrained samples of linen, hide glue, and lead white and Naples yellow oil paints. The thickness of these films are the same shown in their respective figures and would be typical of a common painting. Using this figure it is possible compare the responses of the individual layers to that of an actual canvas painting and to determine the different forces occurring at different levels of RH. For example the fabric is developing high forces at high RH levels and the hide glue is developing high forces at very low RH levels.

The restrained testing of samples from an actual painting

Figure 38 shows the force per width developed in restrained samples of a 1906 painting by Duncan Smith. This painting was constructed with a medium weight machine woven fabric, a hide glue size, a lead white ground and a design layer of raw and burnt umber. It is important to note that there are two areas of high force development, one at the very low levels of RH and the other at the very high levels of RH. This is comparable to the force development of hide glue and the canvas as shown in Fig. 37. When looking at this figure it is easy to determine which layers of an actual painting are developing the highest forces at different levels of relative humidity.

Also when looking at both Figs. 37 and 38, it also becomes apparent which materials are losing all of their strength. For example it is safe to say that above 80% RH the hide glue is no longer acting as the secure bond between the ground and linen canvas. From 80% RH and above the paint layer is clearly at risk of delaminating from the canvas. At this same RH the paints films are the most flexible but are also in their weakest state. From 80% RH and below the forces in the fabric are changing very little. Above 80% RH, the fabric will shrink if loose and certainly delaminate the design layers attached to it. This will be explored in more detail in later sections. One further comment here is that from 10% RH to 75% RH, the force level in the glue layer is so much higher than the other layers, including the linen canvas. In this range the hide glue is the support of the painting.

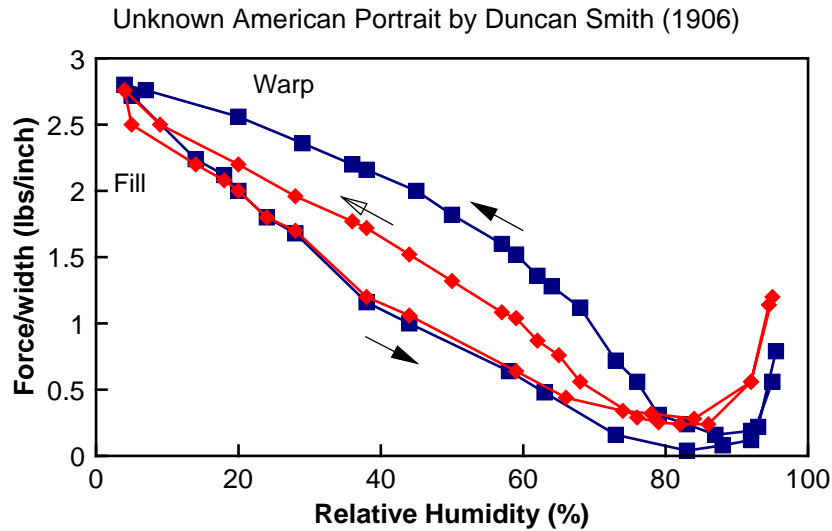

Figure 38 shows the forces per width of restrained samples of an actual painting in both warp and fill directions. These painting samples were constructed with a medium weight machine woven fabric, a hide glue size, a lead white ground and a design layer of raw and burnt umber. It is important to note that there are two areas of high force development, one at the very low levels of RH and the other at the very high levels of RH. This is comparable to the force development of hide glue and the canvas as shown in Fig. 37.

Not all linens show the same behavior. Other linens are woven such that the fill direction yarns are quite straight and have little crimp. It is the crimp in a yarn that causes high humidity shrinkage when loose and high forces when restrained. Figure 39 shows the response of such linen when restrained and subjected to changes in humidity. Linens of this type can show up in commercially prepared artists' canvases where the quality of the linen is lower. In order to get the stiffer feel for the linen heavier layers of glue size are applied to the linen before the oil ground is applied. This results in even higher forces at the low humidity ranges as shown in Fig. 40.

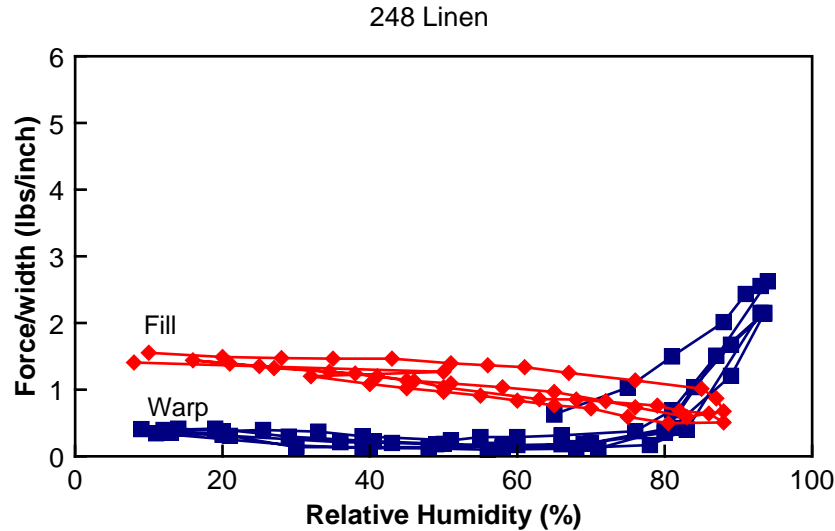

Figure 39 shows the tensile forces per width measured in individual restrained samples of the #248 linen in the warp and fill directions with decreasing relative humidity. In this case the greater forces develop only in the warp direction when the relative humidity is above 80%. The reason there is no force development in the fill direction is because these yarns are quite straight and without the crimp found in the warp yarns.

Figure 40 shows the response to changes in relative humidity of restrained samples of a 1990's painting. This painting was constructed with commercially prepared linen with a heavy glue size. The ground layer was a mixture of lead, titanium and zinc in oil. On top of the ground is a layer of titanium dioxide and zinc oxide in oil. The top design layer was titanium dioxide, zinc oxide, and an earth color in oil. At very high relative humidity, above 80%, the force levels rise dramatically only in the warp direction. Since there is little crimp in the fill yarns there is no force developed. On the other hand the cause of the high forces developed with desiccation is the addition of a thick hide glue size in the painting.

A important point to make is that the starting forces at the beginning of this test were high. Once the humidity was cycled the stresses lowered to equilibrium levels. This painting re-initialized it self and this actually happens frequently. Artist and conservators are routinely re-stretching paintings and there is really no way of knowing the level of stress caused by that stretching. It is almost certain that recently stretched paintings have a high stress level in the different layers.

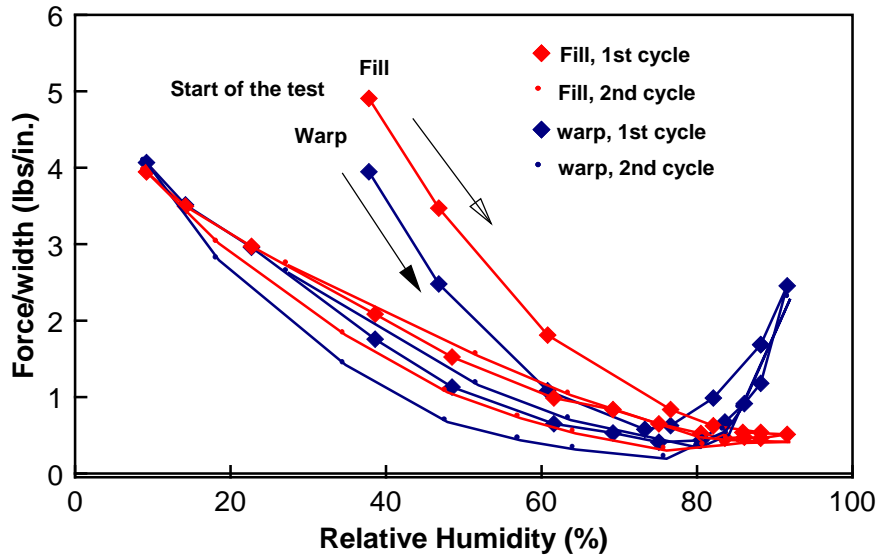

Figure 40 shows the force per width developed in restrained samples of a 1990 painting by an unknown American. This painting was constructed with commercially prepared linen with a heavy glue size. The ground layer was a mixture of lead white, titanium dioxide, and zinc oxide in oil. On top of the ground is a layer of titanium and zinc in oil. The top design layer was titanium dioxide, zinc oxide, and an earth color in oil. At very high relative humidity, above 80%, the force levels rise dramatically only in the warp direction. Since there is little crimp in the fill yarns there is no force developed. On the other hand the cause of the high forces developed with desiccation is the addition of a thick hide glue size in the painting.

Mechanical Damage due to the Expansion of the Stretcher

While directly related to environmental factors it is useful to look at the most obvious sources of damage, the simple expansion of the stretcher. Examining the expansion of a stretcher is also helpful in understanding why the mechanical measurements are useful. Suppose that a small painting of 25 in. x 30 in. is keyed-out in the corners such that there is an expansion of 1/16 in. in each direction for all of the corners as shown in Fig. 41. This means that the 25 in. x 30 in. painting has been expanded a total of 1/8 in. in each direction. This is actually pretty typical for older paintings that have become loose on their stretchers.

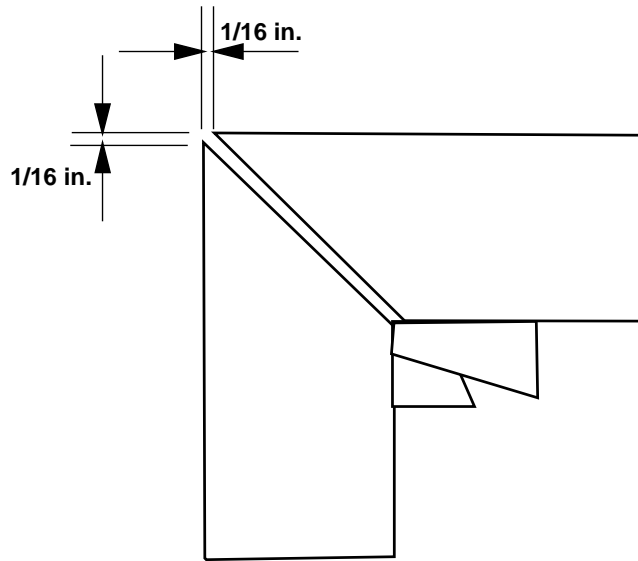

Figure 41, show the corner of a stretcher keyed out 1/16 in. in each direction.

Now let's consider what this deformation does to the actual painting. Figure 42 shows the strains resulting from keying out the 25 in. x 30in. painting a total of 1/8 in. in each direction.

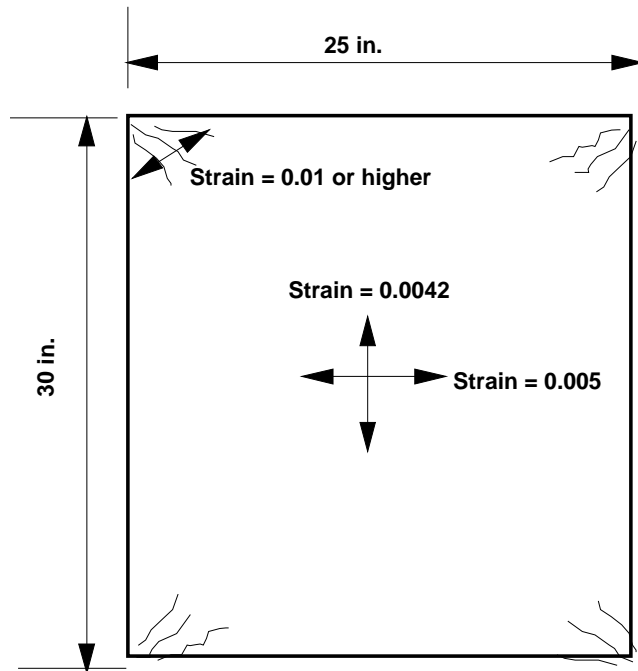

Figure 42, shows the strains resulting from keying out a 25 in. x 30 in. painting a total of 1/8 in. in each direction. Cracking is illustrated in all of the corners.

Strains are calculated as the change in length divided by the original length. In the middle of the painting and in the horizontal direction the strains are 1/8 in. / 25 in. or 0.005 micro strains which is the initial yield point of most artists' materials. This is also 0.5% elongation. In the center of the painting and in the vertical direction, the strains are 1/8 in. / 30 in. or 0.0042 (0.42 % elongation).

In the corners however this is a different story. Because the painting is tacked (stapled) to the stretcher there is little freedom for the painting to expand and the stretcher expansion results in very high strains. The closer to the corner the higher the strains get. This is why one often sees cracks radiating out from the corners of paintings. If cracks do not initially occur at the time of the stretching, desiccation certainly can precipitate it. The point is that the magnitude of the strains typically found in paintings can be used as the criteria for discussing the performance of paints. So if a paint film, as shown in a mechanical test cannot elongate to a strain of even 0.005, (0.5% elongation) then it is most likely going to crack with even modest stretcher expansion. It is generally the extensive distortion of the raw canvas at the tacks or staples near the edges of paintings that relieves the strains on the actual design layers and mitigates the severity of stretching.

Effects of Cycling Canvas Paintings in Large Ranges of Relative Humidity

If a canvas painting, as described in this discussion, is exposed to cycling of large changes in relative humidity then another form of corner cracks can occur. This can be demonstrated by constructing a "mock" painting of canvas, a size layer of hide glue and a "design layer" composed of a hard gesso film having the mechanical properties of an old brittle oil paint film. The dimensions of the painting were 20 in. x 30 in. The gesso layer was a hide glue and calcium carbonate mixture. (Mecklenburg et al, 1994)

Figure 43 illustrates the results of such an experiment. This mock painting was cycled from 90% RH to 35% RH and then back to 90% RH. Each half cycle (from high to low RH or low to high RH) required just less than 24 hours for full equilibration. Periodically the test painting was examined to see what cracking might have occurred. It was observed that with one small exception, all of the cracks occurred at the corners of the painting. At the ends of selected cycles (#4, #7, and #9), the ends of the cracks were noted and marked. For example a crack with a line and a "4" marked next to it indicated the maximum extension of the crack after 4 complete cycles from 90% RH to 35% RH and back to 90% RH.

After nine full cycles the crack extension ceased as was demonstrated by additional cycles. The painting was then subjected to several more severe cycles from 95% RH to 20%RH and back. There was no additional cracking or crack extension. What is of interest is that the first 4 cycles caused the most initial damage and subsequent cycles only produced smaller increments of crack extension until it ceased altogether. More severe cycles did not add to the damage. The cracks

that did occur began to act as expansion joints (removing some of the restraint and relieving further stress) and now the painting can experience large RH cycling without further damage.

From the discussion above hide glue loses strength at high humidity levels but develops very high stresses when desiccated. It was also shown that acting alone paint layers won't generally develop high stresses and damage themselves when restrained and desiccated. It is the desiccation of the glue layer acting on the paint layer that can cause problems. The cracks shown in the corner of the test painting (Fig 43) reflect the effects of the hide glue (and to a small extent the paint itself) pulling from the central regions and away from the corners of the painting. This distorts the design layers sufficiently to cause cracking in the paint layer at the corners. But why is there no cracking in the central regions of the painting? This is because the glue and the paint are contracting simultaneously with desiccation and relieving, not increasing stresses in the paint. It will be shown that exposure to very wet (not just high RH) conditions or low temperature levels cause the severe cracking to the central regions of the paintings.



Figure 43 shows the results of cycling and experimental “mock” painting to cycles of large changes in relative humidity. Additional cycling beyond the initial 9 cycled did no further damage as the cracks that occurred relieved the stresses due to the initial RH cycles. This model painting was constructed with a stretched canvas, a hide glue size and a stiff gesso acting as a design layer.

In an actual painting, it is not unusual to see both the cracking from stretcher expansion and environmental cycling in large ranges of relative humidity combined. This is illustrated in Fig. 44.

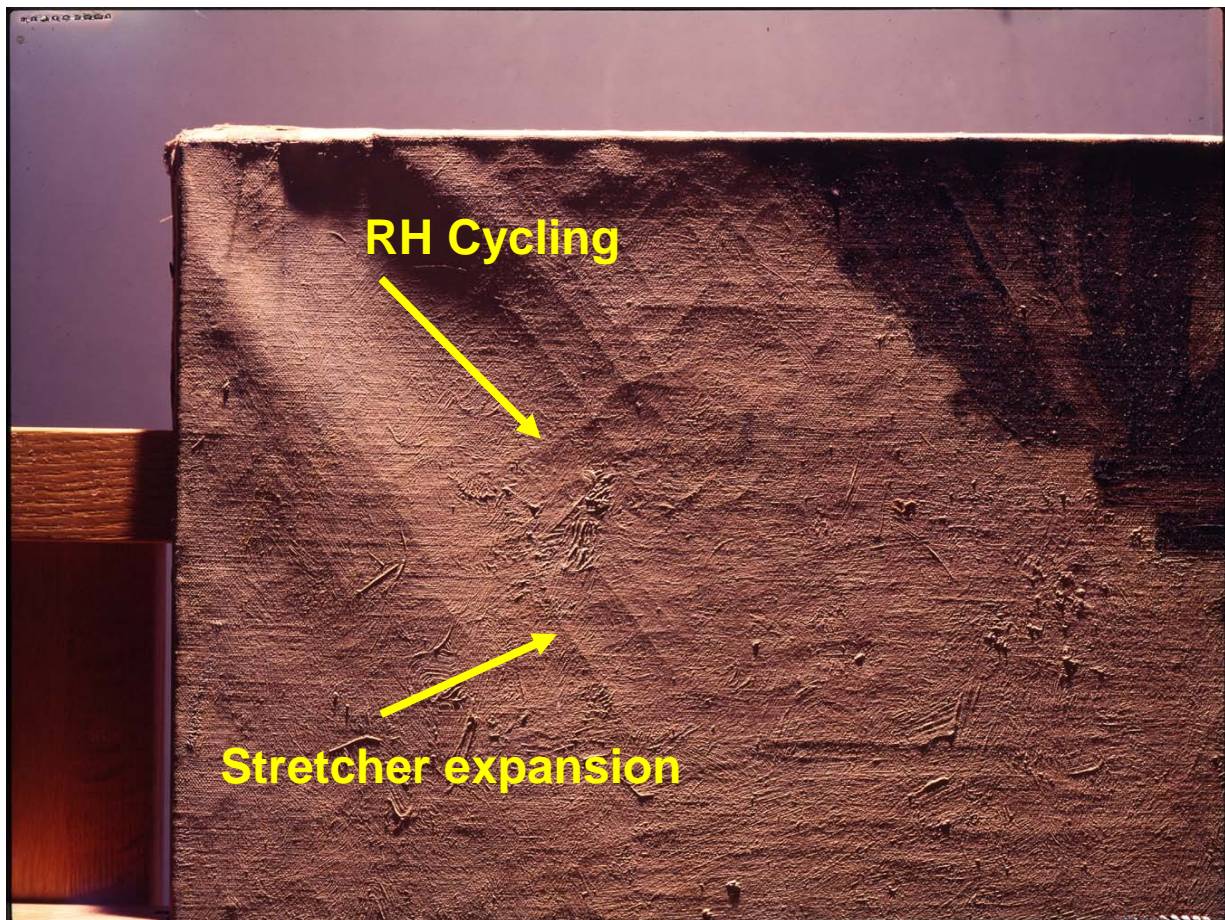

Figure 44 shows the combination of crack patterns from stretcher expansion and cycling in large changes in relative humidity.

Moisture Induced Damage to Canvas Paintings

One of the most frequently encountered types of damage to paintings, both on canvas and on wood is a result of exposure to high moisture levels. In old historic buildings, the moisture can condense on the inside of exterior walls from a variety of reasons. One of those reasons is the excessive humidification of the interior spaces of the building in the wintertime. At such times the exterior walls of older buildings can get quite cold to the point where the interior surfaces reach the dew point. The dew point is the ambient temperature where moisture condenses out of the air. Behind paintings, which can act as insulation, moisture condenses on the cold walls. Conversely in the summertime, the exterior walls get hot and the space behind the painting is warmer than the interior space of the gallery where the painting is exhibited. In such cases the

relative humidity can get as low as 35%. The microclimate behind paintings hanging in the inside surfaces of exterior walls is entirely different than the central gallery space.

Another reason that condensation can occur is that in old stone buildings, the masonry walls are cooled during the wintertime. These massive stone walls, due to their high thermal mass, are slow to warm up with the changing seasons and in the spring time warm moist air enters the building along with visitors through open doors. This results in extensive condensation of not only the walls but paintings hanging on those walls. This occurs on many of the monuments in Washington, D.C.

One of the less frequently considered conditions occurs on very hot, humid days in the summertime. In July in Rome for example, the outside temperature can easily reach 90° F and the relative humidity can reach 65% or higher. Inside a building such as St. Peter's Basilica it is considerably cooler where the temperature can be around 80° F but the relative humidity can be as high as 90%. This is a result of open doors and the outside air cools at it enters the building. The air in such large buildings can stratify and the cooler air remains at the lower levels of spaces where the humidity can be even higher, even approaching the dew point.

Existing environmental conditions are not the only source of high moisture levels. Many of the traditional lining techniques using hide glues and pasta lining adhesives contribute to increasing the moisture content of the painting. This increases the potential for causing massive shrinkage of the original painting canvas and weakening the original glue size.

Water condensing on paintings often tends to run to the bottom of the painting and typically causing damage along the bottoms of the paintings as shown in Fig. 45. In the case of the painting shown in Fig. 46, there was sufficient water on the canvas that it totally disrupted the adhesive bond of the animal glue size layer. Hence the canvas shrank, glue size lost all of its adhesive strength and the paint and ground layers completely delaminated from the canvas. Now there is insufficient room to fit the broken pieces of the paint back into proper alignment.



Figure 45 shows a detail of a 19th century Italian painting. It is clear that total separation of the paint and ground layers from the canvas has occurred. The moisture level was sufficient to cause cracking of the design layers and failure of the bond at the glue layer. The canvas shrank, and the paint cleaved from the canvas. (Photo by Matteo Rossi Doria)



Figure 46 shows a detail of a 19th century Italian painting. It is clear that total separation of the paint and ground layers from the canvas has occurred. The moisture was sufficient to cause the adhesive bond of the animal glue size layer to completely fail. (Photo by Matteo Rossi Doria)

Consequences of the Mechanical and Dimensional Behavior of the Different Oil Paints

If a painting were subjected to severe swings of relative humidity, e.g. between 95% to 35%, then one would expect damage to the design layers of the painting. The high relative humidity can easily be a result of condensing cold exterior wall in historic buildings. Conversely, where exterior walls can get cold they can also absorb heat in the summer time. Warm walls effectively lower the relative humidity of the ambient air in close proximity to the walls. So paintings hanging on the inside of exterior walls can easily be exposed of both cold moist and warm dry environments.

In this example consider a painting that contained paints made with drying oils with earth colors such as Sienna, ochre, and umber and white lead and a size of hide glue. And that the painting was hanging on an exterior wall where there were large changes in relative humidity over an annual cycle. In looking at the mechanical and dimensional properties of the different paints discussed above, one would expect that the white lead paint, because of its strength and resistance to moisture would survive large swings in relative humidity. On the other hand one

might suspect that weak and dimensionally responsive paints like umber, ocher, and Sienna would most likely suffer considerable damage in the same harsh environment. Details of such a painting are shown in Fig. 47.

At high relative humidity the glue size and the earth colors tend to swell and experience “compression set” in much the same way wood might when restrained and exposed to high moisture levels. The earth colors have very little strength and therefore little ability to resist deforming. When the size and earth colors dry out at low levels of relative humidity they will shrink and crack. Once the paint starts to fail the additional failure of the glued size is aggravated and paint flakes off of the painting. Clearly avoiding high humidity levels is of primary importance.

It is now important to note that moisture induced damage to paintings is selective in that the weaker paints will fail and the durable ones will maintain some stability. This is in contrast to damage due to excessively low temperatures which has the same adverse effects on all paints.

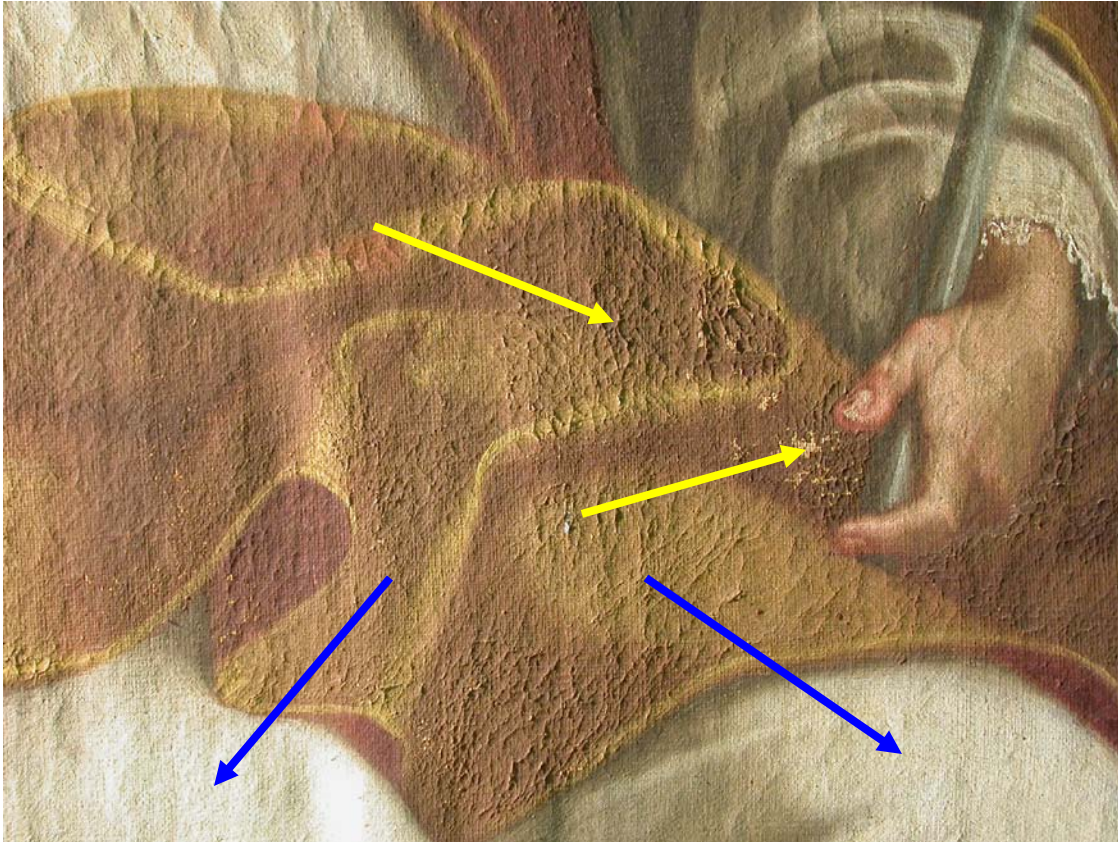

Figure 47 shows the detail of a painting containing both white lead paints (blue arrows) and paints made with the earth colors, ochre and Sienna (yellow arrows). This painting was damaged by wet walls and the selective damage is due to the low strength and high dimensional response to moisture of the earth colors. (Photo by Matteo Rossi Doria)

Commentary on the Ranges and Effects of Exposure to Relative Humidity

If one examines fully restrained cultural materials exposed to changes in relative humidity it is possible to gain insight into the allowable RH ranges they can tolerate safely. This requires that there is information regarding the RH related mechanical and dimensional properties of these materials available.

Using the most stringent criteria such a low yields strains, full restraint of the materials in the most dimensionally unstable direction and even the presence of pre-existing stresses most materials discussed can easily withstand RH ranges from 30% RH to 60% RH reversibly.

Nearly all RH-related damage to both canvas and wood panel paintings and wood furniture is caused by excursions to very high levels of relative humidity or even liquid water and then desiccation to low levels of RH. Prior to the intervention of central heating low levels of relative humidity would mean in the 20% RH to 30% RH range

Add to this the mitigating circumstances:

- Better wood objects are made with woods cut in the radial direction, even the better veneers. They typically have only half of the dimensional response to moisture when compared to tangentially cut woods.
- No material in any collection is completely restrained. Even woods bonded cross grained to one another get some relief from the dimensional response in the longitudinal direction and while this seem to be little it is actually effective.
- Existing cracks in paintings, furniture, ivory act as extremely effective expansion joints. Humidity generated cracking naturally results in the location of high stress regions of any object. Once the cracking occurs, stresses are relieved and the objects are actually free to move where before they were not. Most of these objects are also able to accommodate wider changes in relative humidity, certainly as wide as the ones that caused the cracking in the first place.

Important Exceptions

There are certainly objects in collections that need special care and attention. These include:

- Any materials that have been chemically or biologically degraded to the point where the strains to failure are less than the original yield strain of 0.005. This is especially true for materials with high RH related dimensional response such as woods, ivory, paper. These materials should never be restrained. They should be exhibited in buffered cases or frames.
- Those objects having crossed grain assemblies or wood veneers where the bonding adhesive has degraded. This especially true for wood panel paintings that have cross grain battens glued to the reverse. These paintings are often are hung on the inside surface of exterior walls where the relative humidity behind the paintings can reach 100% on cold winter days and 30% on hot summer days. Actually the inside surface of exterior walls can present a problem for any object hung there. Keeping the RH on the low side in the wintertime and the higher side in the summertime mitigates this adverse condition.
- Those wooden or ivory objects having metal or stone inlays.
- Those objects that have very high pre-existing stresses such as hide drum heads and oriental paper or silk screens. It would be prudent to keep drum heads loose. Pastes such as Japanese wheat starch pasts are actually fairly strong, about half that of the hide glues.

Comparing the Smithsonian RH guidelines to what is possible.

It would be useful to summarize some of the data presented above.

For those materials that are fully restrained and are allowed a strain variation as shown in the text, and an initial stress of zero, the RH range results are as follows.

Material	From	To
• Woods in general	30-32%	62%
• Hide glue	30%	60%
• Ivory	26%	67%
• Gesso	18%	72%
• White Lead Paint	0%	100%
• Titanium White Paint	28%	66%
• Zinc White Paint	16%	63%
• Earth Color Paints	30%	64%

For those materials fully restrained and already under stress:

• Gesso	20%	70%
• Woods	30%	80%
• Linen	10%	90%
• Hide glue	30%	70%
• White lead Paint	20%	75%
• Naples Yellow Paint	20%	75%

Now let's set an average but conservative boundary of between 30% and 60% for the allowable range. These boundaries can be shown on the plots of actual data from the Smithsonian. The existing RH guidelines for the Smithsonian is anywhere at anytime between 37% RH and 53% RH and these are indicated in light blue on the plots in Figs. 46 and 47. Also on these plots are indicated in red are the allowable boundaries. We might call the new regions between **37% RH and 30% RH** and between **53% RH and 60% RH** cautionary regions. **In the cautionary regions the expectation of damage is low for those objects not considered in the Important Exceptions section. Outside the cautionary regions the expectation of damage is very high if the objects are allowed sufficient time. The mitigating effects of the rate of moisture exchange in materials will be covered in a later section**

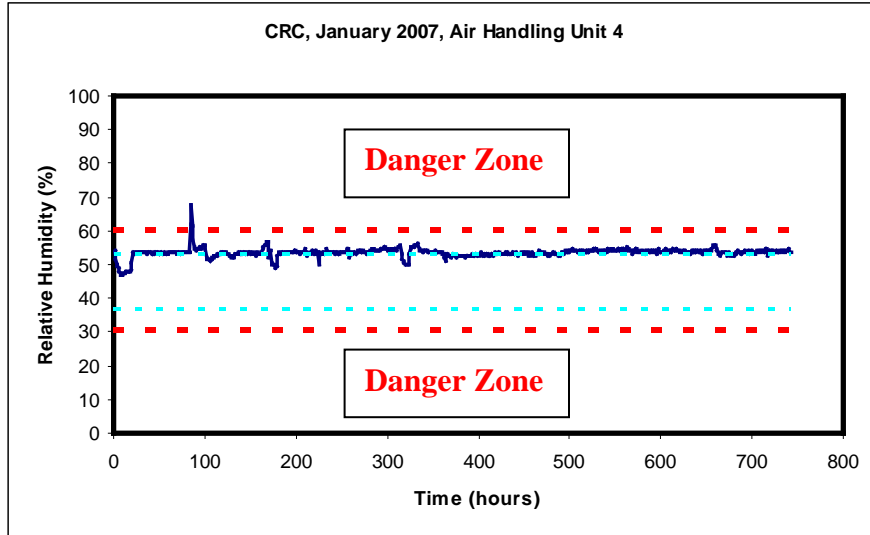

Figure 48 shows the RH monitored data (dark blue line) for the NMAI CRC, AHU 4 in January 2007. Shown on this plot are the current Smithsonian guidelines, inside the light blue lines, the cautionary zone (what is possible) between the red lines and the danger zones, outside the red lines.

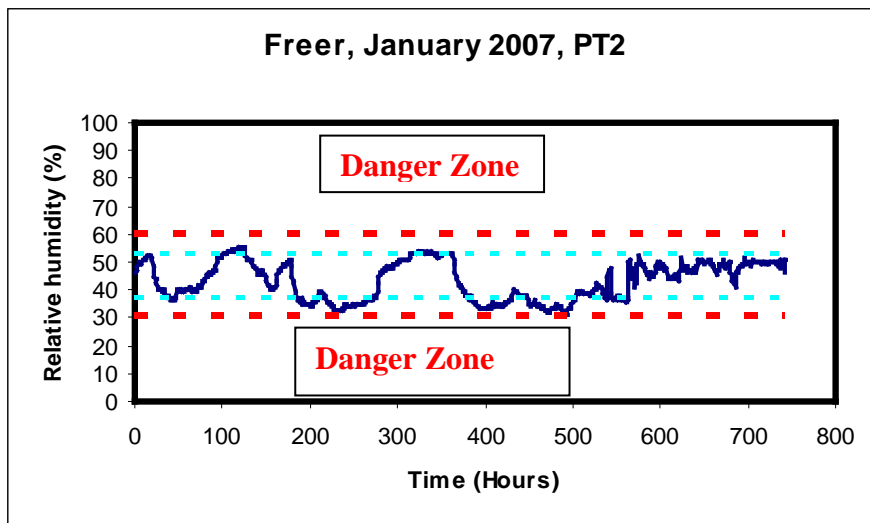

Figure 49 shows the RH monitored data (dark blue line) for the Freer Gallery 18, in January 2007. Shown on this plot are the current Smithsonian guidelines, inside the light blue lines, the cautionary zone (what is possible) between the red lines and the danger zones, outside the red lines.

References

2004, Mecklenburg, M. F., C. S. Tumosa and A. Pride, "Preserving Legacy Buildings," ASHRAE Journal 46(6):S18-S23.

1996, Mecklenburg, M. F. and C. S. Tumosa, "The Relationship of Externally Applied Stresses to Environmentally Induced Stresses", in Fiber Composites in Infrastructure, H. Saadatmanesh and M. R. Ehsani Eds., Proceedings of the First International Conference on Composites in Infrastructure, NSF and University of Arizona, 956-971.

1998, Richard, M., M. F. Mecklenburg, and C. S. Tumosa, "Technical Considerations for the Transport of Panel Paintings". In The Structural Conservation of Panel Paintings, Getty Conservation Institute, 525-556.

1992, Mecklenburg, M.F., "Some Mechanical and Physical Properties of Gilding Gesso," Gilded Wood Conservation and History, D. Bigelow, E. Come, G. J. Landrey, and C. van Horne, Eds., Sound View Press, Madison Conn., 163-170.

2005, Mecklenburg, M.F., Tumosa, C.S., and Erhardt, D., "The Changing Mechanical Properties of Aging Oil Paints," Materials Research Society Symposium Proceedings, Vol. 852, 13-24.

2005, Tumosa, C.S., Erhardt, D., Mecklenburg, M.F., and Xingfang Su., "Linseed Oil as Ionomer: Synthesis and Characterization," Materials Research Society Symposium Proceedings, Vol. 852, 25-31.

1999, Bowron, Edgar, Peters, "A Brief History of European Oil Paintings in Copper 1560-1775," Copper as Canvas; Two Centuries of Masterpiece Paintings on Copper 1575-1775, Phoenix Art Museum, Oxford University Press, N.Y., 11.

1982, Mecklenburg, M.F., "Some Aspects of the Mechanical Behavior of Fabric Supported Paintings," Report to the Smithsonian Institution, Research supported under the National Museum Act.

1988, Hedley, G. "Relative Humidity and the Stress/Strain Response of Canvas Paintings: Uniaxial Measurements of Naturally Aged Specimens," Studies in Conservation, 33, 133-148.

1994, Mecklenburg, M.F., McCormick-Goodhart, M., and Tumosa, C.S., "Investigation into the Deterioration of Paintings and Photographs Using Computerized Modeling of Stress Development," JAIC 33, 153-70.

Please contact Dr. Marion F. Mecklenburg, for permission to use this material.