

Millieriinae,
A New Subfamily of Choreutidae,
with New Taxa from
Chile and the United States
(Lepidoptera: Sesioidea)

JOHN B. HEPPNER

SERIES PUBLICATIONS OF THE SMITHSONIAN INSTITUTION

Emphasis upon publication as a means of “diffusing knowledge” was expressed by the first Secretary of the Smithsonian. In his formal plan for the Institution, Joseph Henry outlined a program that included the following statement: “It is proposed to publish a series of reports, giving an account of the new discoveries in science, and of the changes made from year to year in all branches of knowledge.” This theme of basic research has been adhered to through the years by thousands of titles issued in series publications under the Smithsonian imprint, commencing with *Smithsonian Contributions to Knowledge* in 1848 and continuing with the following active series:

Smithsonian Contributions to Anthropology
Smithsonian Contributions to Astrophysics
Smithsonian Contributions to Botany
Smithsonian Contributions to the Earth Sciences
Smithsonian Contributions to Paleobiology
Smithsonian Contributions to Zoology
Smithsonian Studies in Air and Space
Smithsonian Studies in History and Technology

In these series, the Institution publishes small papers and full-scale monographs that report the research and collections of its various museums and bureaux or of professional colleagues in the world of science and scholarship. The publications are distributed by mailing lists to libraries, universities, and similar institutions throughout the world.

Papers or monographs submitted for series publication are received by the Smithsonian Institution Press, subject to its own review for format and style, only through departments of the various Smithsonian museums or bureaux, where the manuscripts are given substantive review. Press requirements for manuscript and art preparation are outlined on the inside back cover.

S. Dillon Ripley
Secretary
Smithsonian Institution

SMITHSONIAN CONTRIBUTIONS TO ZOOLOGY • NUMBER 370

Millieriinae,
A New Subfamily of Choreutidae,
with New Taxa from
Chile and the United States
(Lepidoptera: Sesiioidea)

John B. Heppner



SMITHSONIAN INSTITUTION PRESS

City of Washington

1982

ABSTRACT

Heppner, John B. Millieriinae, A New Subfamily of Choreutidae, with New Taxa from Chile and the United States (Lepidoptera: Sesioidea). *Smithsonian Contributions to Zoology*, number 370, 27 pages, 63 figures, 1 table, 1982.—The new subfamily, Millieriinae, is described in Choreutidae and includes one European genus, *Millieria* Ragonot, with its single species *Millieria dolosana* (Herrich-Schäffer), as well as two new genera and species: *Phormoestes*, new genus, including *Phormoestes palmettovora*, new species, from Florida; and *Nyx*, new genus, including *Nyx puyaphaga*, new species, from central Chile. All taxa are described, illustrated, and discussed regarding their relationships. Host plants include *Aristolochia clematidis* Linnaeus and *Aristolochia pistolochia* Linnaeus (Aristolochiaceae) for *Millieria*, *Sabal palmetto* (Walter) Loddiges (Palmae) for *Phormoestes*, and *Puya alpestris* (Poeppig) Gay (Bromeliaceae) for *Nyx*.

OFFICIAL PUBLICATION DATE is handstamped in a limited number of initial copies and is recorded in the Institution's annual report, *Smithsonian Year*. SERIES COVER DESIGN: The coral *Montastrea cavernosa* (Linnaeus).

Library of Congress Cataloging in Publication Data

Heppner, John B.

Millieriinae: a new subfamily of Choreutidae, with new taxa from Chile and the United States (Lepidoptera: Sesioidea)

(Smithsonian contributions to zoology ; no. 370)

Bibliography: p.

Supt. of Docs. no.: SI 1.27:370

1. Choreutidae—Classification. 2. Insects—Classification. 3. Insects—United States—Classification. 4. Insects—Chile—Classification. I. Title. II. Series.

QLI.S54 no. 370 [QL561.C47]. 59ls [595.78'1] 82-600162 AACR2

Contents

	<i>Page</i>
Introduction	1
Acknowledgments	1
MILLIERIINAE, new subfamily	2
Key to the Genera of Millieriinae	5
<i>Millieria</i> Ragonot	6
<i>Millieria dolosana</i> (Herrich-Schäffer)	7
<i>Phormoestes</i> , new genus	9
<i>Phormoestes palmettovora</i> , new species	11
<i>Nyx</i> , new genus	12
<i>Nyx puyaphaga</i> , new species	13
Literature Cited	15
Figures 3-63	16

Millieriinae, A New Subfamily of Choreutidae, with New Taxa from Chile and the United States (Lepidoptera: Sesiioidea)

John B. Heppner

Introduction

Following the completion of a review of Sesiioidea classification (Heppner and Duckworth, 1981), specimens of the immature stages of the genus *Millieria* Ragonot became available and were found to have many characters anomalous to other Choreutidae known thus far, indicating that a new subfamily would be needed. Among these characters the most notable are double rows of spines on the abdominal tergites of the pupa (being only single rows in other Choreutidae) and the bisetose L-group on the larval prothorax (being trisetose in other Choreutidae). The adults of *Millieria dolosana* (Herrich-Schäffer), the only known member of this European genus, have most characters typical of other choreutids. Their biology, contrarily, is very distinct from other choreutids, being the only known leaf miners in the family. In addition, a new genus and new species from Florida was found to have anomalous immature characters, as well, yet with some conformity to *Millieria*. Further investigation also revealed affinities between *Millieria*, the Florida

genus, and an undescribed moth from central Chile, which previously had been too unusual to relate to other known Choreutidae.

All these taxa are described below and associated within the new subfamily, Millieriinae. The immature characters of the subfamily, while divergent from other Choreutidae, demonstrate the characters showing the affinities of Choreutidae with Sesiidae and Brachodidae, the other two sesioid families. Thus, the Millieriinae are somewhat of a missing link between other Choreutidae and the remainder of the Sesiioidea, further confirming their fundamental relationships.

ACKNOWLEDGMENTS.—Curators from several institutions kindly provided label data or specimens for study (museum or collection acronyms to the left are used in the text as necessary):

BMNH	V.O. Becker, % British Museum (Natural History), London, England.
CPK	C.P. Kimball Collection, West Barnstable, Massachusetts
FSCA	H.V. Weems, Jr., Florida State Collection of Arthropods, Gainesville, Florida
IEEM	Instituto Español de Entomología, Madrid, Spain
JBH	J.B. Heppner Collection, Washington, D. C.
JK	J. Klimesch Collection, Linz, Austria

John B. Heppner, Department of Entomology, National Museum of Natural History, Smithsonian Institution, Washington, D.C. 20560.

MGAB	A. Popescu-Gorj, Muzeul de Istorie Naturala "Grigore Antipa," Bucharest, Romania
MHNP	G. Luquet, Museum National d'Histoire Naturelle, Paris, France
MNV	Museo Civico di Storia Naturale, Verona, Italy
NHNV	F. Kasy, Naturhistorisches Museum, Vienna, Austria
PPE	P. Passerin d'Entreves Collection, Torino, Italy
USNM	Collections of the former United States National Museum, now in the National Museum of Natural History, Smithsonian Institution, Washington, D.C.
ZIL	Zoological Institut, Academy of Sciences, Leningrad, USSR

I also thank the University of Florida, Gainesville, Florida, for logistical help during recent field research on the Florida species described in this paper. M.P. Gomez Bustillo kindly provided specimen data for the collection of the Instituto Español de Entomología, Madrid, Spain, and P. Passerin d'Entreves kindly provided the specimen data for the collection of the Museo Civico di Storia Naturale, Verona, Italy.

J.F.G. Clarke (Smithsonian Institution) and R.W. Hodges (U.S. Department of Agriculture, Washington, D.C.) kindly provided their helpful criticisms and suggestions. V. Krantz (National Museum of Natural History Photographic Unit, Smithsonian Institution) did the photography for the halftone illustrations.

MILLIERIINAE, new subfamily

TYPE-GENUS:—*Millieria* Ragonot, 1874:173 (type-species: *Choreutis dolosana* Herrich-Schäffer, 1854; type locality: Hungary).

ADULT.—Small moths, 3–5 mm forewing length.

Head: Frons and vertex vestiture smooth. Haustellum scaled at base. Maxillary palpus small, 1-segmented (one species may have 2 segments). Labial palpus upcurved, or slightly upcurved, with or without ventral scale tuft on second segment. Ocellus present, relatively small. Antenna filiform, sometimes thickened; ventral setae not prominent; without pecten on scape.

Thorax: Normal form. Legs with normal tibial spurs (0-2-4).

Forewing: Wing shape elongate, with somewhat pointed apex. Sc to margin near midwing. Radial veins unbranched. Median veins M_1 to M_3 present. Chorda present or absent. Pterostigma present. Median cell with or without vestigial vein present. Cubital veins present. CuP present at tornal margin, extended basally as fold. A_{1+2} with large basal fork, or fork only to 1/3 vein length. A_3 vestigial.

Hindwing: Wing shape elongated, subtriangular, with somewhat pointed apex. Sc+ R_1 to costal 3/4 wing length from base. Median vein usually unbranched; M_3 may be stalked with Cu A_1 near end of cell. Cubital veins present. CuP present at tornal margin, continued basally as fold. Anal field wide; 4 anal veins present, with A_{1+2} with long basal fork; A_3 prominent; A_4 prominent or reduced.

Abdomen: Normal form. Coremata present or absent.

Male Genitalia: Tegumen and vinculum fused. Saccus small or reduced. Uncus and gnathos present; gnathos may be a complex fused to a scaphium. Socius developed or absent. Valva simple. Anellus plate-like or modified, sometimes with lateral appendages. Aedeagus without cornuti, or with a small tubular cornutus. Phallobase absent.

Female Genitalia: Ovipositor ranging from short to very long, with setaceous papilla analis or modified for piercing with sharp papilla analis. Apophyses normal or greatly elongated and strengthened. Ostium a simple funnel. Sterigma present or absent, with 8th tergite sometimes modified for incision. Ductus bursae elongated, membranous. Corpus bursae simple, with or without signa.

LARVA.—Head hypognathous or slightly prognathous. Frontoclypeus 1/2 or completely to epicranial notch. Stemmata in semicircle. Proleg short or reduced; crochets uniordinal or biordinal circles. Prothorax with sclerotized shield; L-group bisetose on single pinaculum (trisetose on meso- and metathorax); SD1 distant or somewhat close to SD2; SV setae approximate on single pinaculum. Meso- and metathorax with L1 approximate

TABLE 1.—Analysis of selected characters of Millieriinae and Sesioidea (characters for immature stages of Millieriinae are based only on *Millieria* and *Phormoestes*)

Character	Plesiomorphic	Apomorphic
1. Abdominal apodemes	tineoid	tortricoid
2. Larval L-group setae	bisetose	trisetose (usually)
3. Pupal maxillary palpi	small	large
4. Haustellum	naked	scaled
5. Forewing pterostigma	absent	present
6. Larval crochets	transverse	circle/penellipse
7. Adult maxillary palpi	1-3 segmented	1-2 segmented
8. Antenna	filiform	various
9. Larval L-group setae	bisetose	trisetose
10. Larval proleg	normal or reduced	very long
11. Larval D2 setae on A8	D2 closer than D1 (or equidistant)	D1 closer than D2
12. Pupal dorsal spines	2 rows	1 row
13. Larval head	hypognathous	semi-prognathous
14. Adult abdominal coremata	absent	present (sometimes)
15. Forewing chorda	present (usually)	absent
16. Chaetosemata	absent	present (usually)
17. Wing coupling	absent	present
18. Hindwing vein A ₁₊₂	short basal stalk	long basal stalk
19. Larval head setae	normal lengths	very long
20. Female ostium	simple	modified
21. Male anellus	simple, flat	modified
22. Larval setae on A9	D2 normal length	D2 very long
23. Pupal dorsal spines	2 distinct rows	2 diffuse rows
24. Compound eye	laterally extended	convex, retracted
25. Female ovipositor	unspecialized	modified for piercing
26. Larval crochets	uniordinal	biordinal
27. Larval habits	borers	leaf miners
28. Hindwing veins M ₃ and CuA ₁	free	stalked
29. Head caudal condyli	present	absent
30. Male socius	absent	present
31. Male anellus appendages	absent	present
32. Larval frontoclypeus	half to epicranium	reaching epicranium
33. Adult maxillary palpi	2-segmented (?)	1-segmented
34. Female signum	absent	present
35. Female sterigma	absent	present
36. Forewing chorda	present	absent
37. Forewing cell median vein	vestigial	absent
38. Pupal case	absent	specialized

to L2, distant to L3. Abdominal segment A2 with SV setae in triangle or almost in line; segments A1-8 with SD2 small or minute and closer to spiracle than SD1 or equidistant; L2 approximate to L1 or distant but still closer than to L3; D2 setae more apart than D1 except on A8, where D1 and D2 are almost equally wide apart or wider apart.

PUPA.—Head with protrusion on front. Dorsal

spines in 2 rows on tergites A2-7 in male (A2-6 in female), with one row on A8-9, or modified as diffuse spine field yet retaining distinguishable double rows; segments A3-7 movable in male (A3-6 in female). Cremaster undeveloped. Pupation in case on leaf surface; pupa protruded at adult eclosion.

HOST FAMILIES.—Bromeliaceae, Palmae, Aristolochiaceae.

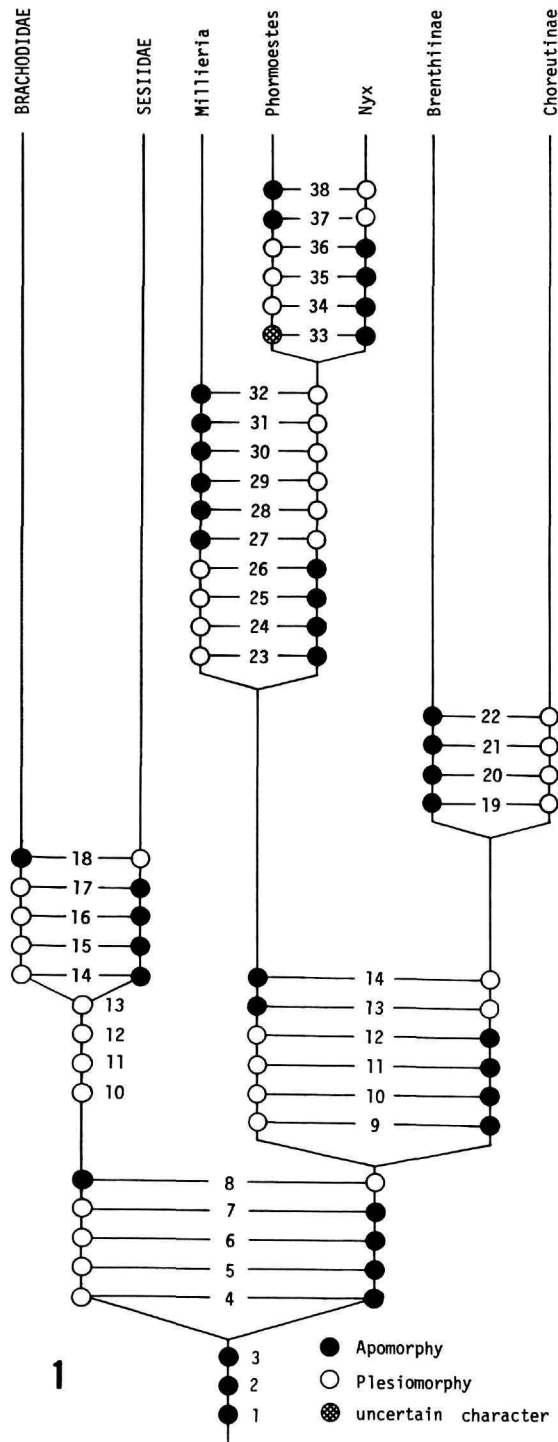

REMARKS.—The most significant aspect of this group involves their bridging the gap between Brachodidae and Sesiidae, the other two families of Sesiioidea, and the remaining Choreutidae genera. The larvae and pupae of choreutids until now were different from other Sesiioidea in some characters, notably the single spine rows on the dorsum of the pupal abdominal segments. The bisetose pre-spiracular L-group setae of the larval prothorax, which is the same as in known Brachodidae (*Sagalassa*), also show that the higher choreutids have developed from some ancestral Brachodidae (other Choreutidae are trisetose). In Brachodidae and Millieriinae, the prothoracic bisetose L-group condition becomes the normal trisetose condition on the meso- and metathorax, like other Sesiioidea.

The new genus from Florida (*Phormoestes*) shows similarities to *Millieria* in the larva, while the pupa has the basic characteristics of the new subfamily. The pupa diverges, however, by its unusual diffused spine rows. This new genus is certainly a tropical element. Immature characters are not known for the new genus (*Nyx*) from Chile. Additional characters that differentiate Millieriinae from other choreutids include the short or reduced larval prolegs; the closer prothoracic SD1 and SD2 setae (*Millieria*), which is similar to the condition in Sesiidae; and the D2 setae on abdominal segment 8. The D2 setae are equally close to D1 or closer than D1 setae; this relationship is the same in species of Brachodidae and Sesiidae, but the opposite of other Choreutidae. Although adults of *Millieria* appear like typical choreutids, larval characters like the long frontoclypeus and the reduced prolegs show differences from typical choreutids. In the new Florida genus the opposite is true. Thus from various larval characters and from the double rows of spines of the pupa, the Millieriinae very interestingly demonstrate the evolutionary connection

FIGURE 1.—Hypothetical phylogeny of Millieriinae genera in relation to other Choreutidae and Sesiioidea (characters listed in Table 1; characters 10–14 are charted for all three families to note some symplesiomorphies.).

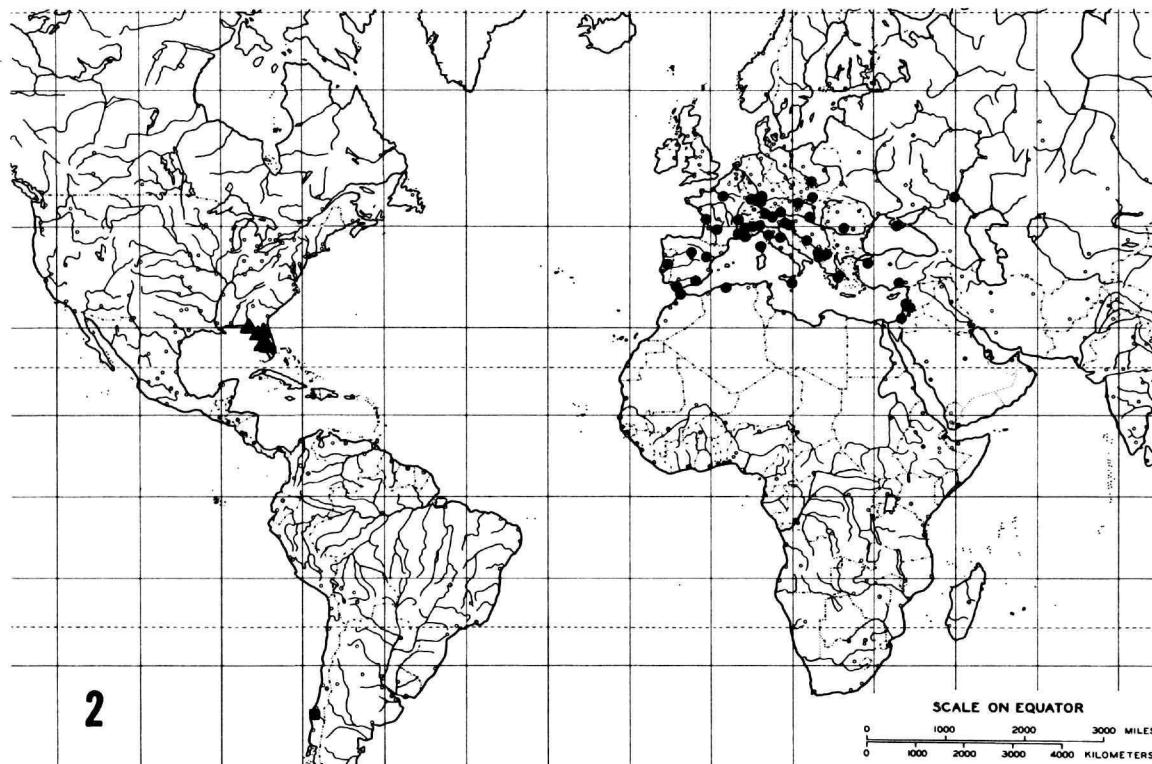

FIGURE 2.—Distribution of Millieriinae taxa (circle = *Millieria*; square = *Nyx*; triangle = *Phormoestes*).

between Choreutidae and Brachodidae. The Sesiidae probably are a separate offshoot from ancestral Brachodidae. Table 1 summarizes these and other characters to show a hypothetical phylogeny for Millieriinae and Sesiioidea (Figure 1).

The Millieriinae currently contain only three genera, each monotypic, distributed in a very disjunct pattern (Figure 2): one genus in Europe, one in Florida, and one in central Chile. Although the three genera are related, the distributional pattern leads one to conclude that other species, if not genera, remain to be discovered. The two New World genera both have hosts among the monocots, while the *Millieria* host is a dicot plant.

The Millieriinae conform to certain basic characteristics of Choreutidae (small, usually 1-segmented maxillary palpi; prominent ocelli; scaled haustellum; a forewing pterostigma; tortricoid abdominal apodemes; pupal dorsal spines), which distinguish the family from groups having a superficial resemblance in Gelechioidea, notably some Oecophoridae. Among the characters just noted, except for the scaled haustellum and the pterostigma, Oecophoridae have each character state the opposite of what is found among Choreutidae (Heppner, 1977:126). (Very rarely do some Gelechioidea have what appears to be a tortricoid abdominal apodeme arrangement.)

Key to the Genera of Millieriinae

- 1. Forewing with chorda 2
- Forewing without chorda **Nyx**

2. Hindwing with M_3 and CuA_1 stalked *Millieria*
 Hindwing with M_3 and CuA_1 free *Phormoestes*

Millieria Ragonot

Millieria Ragonot, 1874:173 [type-species: *Choreutis dolosana* Herrich-Schäffer, 1854 (by original designation)].
Ripismia Wocke, [1876]:399 [type-species: *Choreutis dolosana* Herrich-Schäffer, 1854 (by monotypy)].
Rhipismia Reutti, 1898:180 [unjustified emendation].
Milliereia Spuler, 1910:298 [unjustified emendation].
Milliera.—Le Marchand, 1937:192 [misspelling].
Millieroa.—Le Marchand, 1937:192 [misspelling].

ADULT.—Small moths, 4.0–4.8 mm forewing length.

Head (Figure 3): Vertex and frons with smooth vestiture. Labial palpus upcurved, with scale tuft on second segment ventrally; basal and apical segments subequal, middle segment half again as long as apical segment. Haustellum scaled basally. Maxillary palpus small, 1-segmented (Figure 4). Pilifer large. Eye of average size, somewhat projected laterally, strongly convex. Ocellus small. Antenna filiform. Caudal end of head (Figure 9) with tentorial bridge subtending a large upper ovate opening from a triangular trapezoidal lower opening; occipital condyli not evident.

Forewing: Shape (Figure 12) elongate, with slightly pointed apex; rounded tornal and anal margins. Pterostigma small, from Sc to R_5 ; chorda present. Sc to 1/2 along costal margin. R_1 to 2/3 from base. R_2 – R_5 veins evenly spaced; R_5 to apex. Cell long (3/4 wing length), with vestigial median vein. Median veins evenly spaced; M_3 not stalked with CuA_1 . CuA_1 parallel to CuA_2 , which diverges from near end of cell. CuP present at tornal margin. A_{1+2} with long basal fork; A_3 vestigial.

Hindwing: Shape elongate, with subovate anal field. Sc to 3/4 at costal margin. R_5 to near apex. Cell half wing length, with vestigial median vein. M_1 to apex; M_2 evenly spaced between M_1 and M_3 . M_3 stalked with CuA_1 from near end of cell; CuA_2 parallel to CuA_1 . CuP present at tornal margin. A_{1+2} with moderate basal fork; A_3 long; A_4 nearly subequal to A_3 .

Abdomen: Normal form. Coremata absent.

Male Genitalia: Tegumen fused to vinculum. Saccus absent. Uncus present. Gnathos a complex of lateral arms attached to a sclerotized scaphium. Socius prominent. Transtilla part of gnathos arrangement. Valva simple. Anellus plate-like, with a lateral process. Aedeagus small, narrow. Cornutus present as a small tube.

Female Genitalia: Ovipositor normal. Papilla analis setaceous. Apophyses of average length and stoutness. Ostium simple, a membranous funnel. Sterigma present, projected posteriorly. Tergite of 8th segment with sclerotized projection. Ductus bursae membranous. Corpus bursae simple. Signum present.

LARVA (Figures 25–33).—Head (Figures 26, 27) somewhat prognathous; frontoclypeus to epicranial notch. Stemmata in semicircle. Exoskeleton of body with numerous minute spines. Proleg reduced; crochets (Figure 28) few in number, in uniordinal irregular circle. Prothorax with sclerotized dorsal shield; L-group bisetose on single pinaculum (trisetose on meso- and metathorax); SD1 and SD2 close together; SV setae approximate on one pinaculum. Meso- and metathorax with L1 and L2 approximate and distant from L3. Abdominal segment A2 with SV setae in slight triangle (in line on segments A3–7). Abdominal segments A1–8 with SD2 small, anterior and close to spiracle, with SD1 distant; L2 anterovertrally to L1, distant but closer to L1 than to L3; D2 more apart than D1 on segments A1–7, almost equidistant on segment A8, and closer together than D1 on segment A9.

PUPA (Figures 34–36).—Head with pointed projection on front, with 2 long lateral setae. Maxillary palpus prominent. Legs extended beyond wing tips. Dorsal abdominal spines present in two rows on tergites A2–7 in male (A2–6 in female), with single row on tergites A8–9. Abdominal segments A3–7 movable in male (A3–6 in female). Cremaster undeveloped, but somewhat

hook-tipped setae present on segment A10. Pupation in a round lentil-like case of leaf material in mine on leaf surface (Figure 37); pupa protruded at adult eclosion.

REMARKS.—*Millieria* has always been viewed as a strange genus among the choreutid moths, primarily because of the unusual biology of its only included species, *M. dolosana*. As noted under the subfamily discussion, now that this genus has been found related to two unusual New World genera, its place in the phylogeny of the Choreutidae is more understandable. Previously it had only been thought somewhat related to *Anthophila* (Heppner and Duckworth, 1981:47) or *Tebenna* (Diakonoff, in press).

This European genus is morphologically distant from the New World genera of Millieriinae, yet relationships are evident in adult wing venation and larval chaetotaxy. The simple (i.e., distinct spine rows, as in Sesiidae) dorsal spines of the pupa and the overall facies of the adult in their resemblance to other Choreutidae indicate that this genus is less derived from some ancestor than are two New World genera, which appear much more advanced.

The larva of *Millieria* is most unusual for its head morphology, being very similar, both in head shape and the extent of the frontoclypeus, to larvae of leaf mining families like Gracillariidae. The reduction of the prolegs also conforms to this overall appearance of a gracillariid-like larva, apparently being due to the similar feeding habits of the larvae.

The pupa, as noted before, is striking in its similarity to pupae of Brachodidae and Sesiidae, with the two distinct rows of dorsal spines of the abdominal segments.

***Millieria dolosana* (Herrich-Schäffer)**

Choreutis dolosalis Heydenreich, 1851:63 [nomen nudum].

Choreutis dolosana Herrich-Schäffer, 1854:95.

Choreutes [sic] *dolasona* [sic].—Desmarest, [1857]:228.

ADULT MALE (Figure 15).—4.0–4.8 mm forewing length.

Head: Dark buff, with white eye border on

frons. Labial palpus white, with black scales intermixed on ventral scale tuft of middle segment; apical segment smooth, black and white, pointed. Venter of head white.

Thorax: Bronze fuscous to buff. Patagia bronze fuscous. Venter white. Legs white with dark fuscous on ends of all segments.

Forewing: Bronze fuscous on basal half of wing, dark fuscous on distal half; horizontal white line along radius from base to 1/3 of wing; white crescent mark at midwing from dorsal margin to center of wing; another white mark at midwing on costal margin, with silver between it and dorsal crescent mark; irregular cross mark of dark fuscous on apical 1/4 of wing, with silver on central parts of it; two white marks on costal margin near apex; white tornal mark, with silver mark basad of it. Fringe silver, dark fuscous more distally, and white on extremities. Ventral side fuscous with white marks near apex of costal margin, at tornus, and white over anal field.

Hindwing: White with fuscous distal border. Fringe fuscous, white distally and along anal margin. Ventral side similar to dorsal side.

Abdomen: Fuscous, with white ring on each segment. Venter mostly white.

Male Genitalia (Figure 21): Tegumen fused with reduced vinculum. Saccus absent. Uncus present as round sclerotized ring with a median notched uplift. Gnathos present as paired arm, partially fused as a transtilla, bending upward to large densely setaceous socius; gnathos connected to strongly sclerotized scaphium fused to uncus and projecting posteriorly to a bulbous end. Valva elongate, with rounded end, with a short pointed spine on dorsal margin near distal end; distal 1/4 of valva setaceous. Anellus triangular with concave dorsal margin and broad convex ventral margin merging into short setaceous lateral process at base of valva. Aedeagus (Figure 22) short, slightly curved to narrowed distal end; phallobase absent. Cornutus a small tube.

FEMALE (Figure 16).—Similar to male except hindwing fuscous. Fringe fuscous and white distally.

Female Genitalia (Figure 23): Ovipositor short,

with small setaceous papilla analis. Apophyses slender, with anterior pair $2/3$ length of posterior pair. Ostium a large ovate opening surrounded by a sclerotized sterigma projected posteriorly to a truncated edge, with a similar round flat projection on the 8th tergite. Ductus bursae narrow, membranous to slightly bulbous area where ductus seminalis joins, then continuing with a gradual widening to bursa. Corpus bursae ovate with a bifurcate signum (Figure 24) projected from a ventral cestum where ductus bursae meets corpus bursae.

Larva and pupa as described for the genus.

TYPE.—Lost?

TYPE LOCALITY.—Hungary.

ADDITIONAL SPECIMENS (135 ♂, 90 ♀).—*Albania*: Durazzo, 24 Apr 1917 (♂), NHMV. Kula Ljums, 18–28 May 1918 (♂), NHMV.

Algeria: Punta Pescade, Algiers, 27 Apr 1893 (2 ♂), Eaton, BMNH.

Austria: Austria, no date (3 ♀), IEEM; no date (♂, 2 ♀), Mann coll., MGAB. Bozen, Tirol, no date (♀), NHMV. Gumpoldskirchen, 23 Jun 1979 (♂, 3♀), 5–15 Jul 1966 (♂), NHMV. Himberg, 2 Jul 1967 (♀), NHMV. Leiser Berge, 1 Jun 1913 (♂), NHMV. Marchauen, 12–13 Jul 1939 (2 ♂), NHMV. Vienna, no date (2 ♂, 2 ♀), BMNH; no date (♂), NHMV; 1872 (3 ♀), NHMV; 25 May 1938 (♂), 12 Jul 1939 (2 ♀), 13 Jul 1939 (2 ♂), 15 Jul 1939 (♂), 16 Jul 1939 (♂), 21 Jul 1939 (♀), NHMV; 12 Jul 1898 (♂), Hamfeldt, USNM; 18 Nov 1901 (♀), USNM.

Czechoslovakia: "Slovakia," no date (Diakonoff, in press).

France: Bergheim, Dept. Alsace, Jul (♂) (Fettig, 1882:113). Cannes, Dept. Alpes-Maritimes, 22 Mar 1896 (2 ♂), 11 Apr 1896 (2 ♂), 5 May 1890 (♂), Walsingham, BMNH; no date (♀), Jourdeuille, MHNP; no date (♂, ♀), IEEM. Diene, Dept. Basses-Alpes, 16–23 Apr 1897 (♂), Tutt, BMNH. Douelle, Dept. Lot, 27 May 1940 (14 ♂, 5 ♀), 26 Jul 1937 (♂), Lhomme, MHNP. Golfe Juan, Dept. Alpes-Maritimes, Aug 1882 (3 ♂, 3 ♀), Constant, BMNH. Lyon, Dept. Rhone, no date (♀), BMNH; 31 May 1858 (♂), 6 Jun 1858 (♂), 12–21 Jun 1858 (2 ♀), 19 Jun 1858 (♀),

Millière, ex *Aristolochia clematitis*, BMNH. Oléron, Dept. Charente-Maritime, 15 Aug 1920 (4 ♀), Dumont, ex *A. clematitis* MHNP. Paris, Dept. Seine, no date (2 ♂, 2 ♀), BMNH; no date (♂), USNM; 1 Apr 1880 (2 ♂, ♀), Ragonot, USNM; 1874 (3 ♂, 2 ♀), 29 Apr 1880 (♂, 2 ♀), Ragonot, BMNH. Pont du Gard, Dept. Gard, 30 May 1936 (♀), G. Praviel, MHNP. Punta Parata, Dept. Corsica, 7 Jun 1899 (2 ♂), Walsingham, BMNH.

Germany: "Germany," no date (4 ♂, 5 ♀), Hoffman, Hamfeldt, and Staudinger, USNM. Stuttgart, 25 Feb 1933 (2 ♂), 28 Feb 1933 (♂, ♀), 7 Mar 1933 (2 ♂), 6 Apr 1938 (♂, ♀), 6 Jun 1938 (2 ♂, ♀), 10 Jun 1935 (♂), 10 Jun 1938 (2 ♀), 15 Jun 1939 (♂), 25 Jun 1938 (♂), J. Klimesch, ex *A. clematitis*, JK; 16 Jun 1939 (2 ♀), J. Klimesch, BMNH. Württemberg, 12 Mar 1933 (2 ♂), 4 Apr 1934 (2 ♀), 24 May 1938 (♀), no date (♀), A. Wörz, ex *A. clematitis*, E. Jäckh, USNM; 25 May 1940 (♂, ♀), A. Wörz, ex *A. clematitis*, E. Jäckh, JBH.

Greece: "Attica," Sep 1954, F. Kasy, larvae on *Aristolochia* sp. (Klimesch, 1968:149); 20 Nov (2 ♂) (Staudinger, 1870:272).

Hungary: "Hungary," 3 Oct 1896 (2 ♂), USNM; no date (♀), J. Schlumberger, MHNP; no date (♂), Mann, MGAB. Csterspai, 23 Aug 1964 (♀), Stamm, USNM. Pecs, 27 Jun 1937 (3 ♂, 3 ♀), 28 Jun 1937 (2 ♂, 2 ♀), J. Klimesch, ex *A. clematitis*, JK.

Israel: Iriskam, 1947 (2 ♂), BMNH. Jerusalem, no date (♀), MGAB.

Italy: Conconello, Trieste, Prov. Friuli-Venezia Giulia, 22 Apr 1964 (3 ♂), J. Klimesch, JK. Livorno, Prov. Tuscany, no date (♂), NHMV. Monfalcone, Prov. Friuli-Venezia Giulia, 24 Apr 1909 (♂), NHMV. Ragusa, Sicily, 1868 (2 ♀), NHMV. Trento, Prov. Trentino-Alto Adige, 2 Jul 1945 (♂), J. Klimesch, JK. Vigevano, Pavia, Prov. Lombardy, 15 Apr 1945 (♂), J. Klimesch, JK. Rubiana, Valle di Susa (Torino), Prov. Piedmont, no date (2 ♀), PPE. Ladino, Forli, Prov. Emilia Romagna, June (1 ♂), Zangheri, MNV.

Lebanon: Beirut, Mar 1886 (♂), Pratt, BMNH; 1893 (♂, ♀), NHMV.

Morocco: Tangier, 6 May 1902 (♂), 10 Dec 1901 (♂), Walsingham, BMNH.

Poland: Myszkow, Katowice Prov., 22 Jun 1934 (♀), P. Zaleszczyki, BMNH.

Portugal: Portas de Rodan, Beira Baixa Prov., May (Zerkowitz, 1946:129).

Romania: Walouikoi, 28 Jun 1888 (♀), NHMV.

Spain: "Andalusia," no date (♂, ♀), J. Schlumberger, MHNP. La Linea de la Concepcion, Adiz Prov., no date (♂), T. Mendez, IEEM. "Castilia," no date, ZIL (Diakonoff, in press). Albarracin, Teruel Prov., July 1924 (♀), NHMV; no date, (♂), IEEM. La Granja, Granada Prov., no date (2 ♂), Dumont, MHNP. Valdealgorfa, Teruel Prov., 6 Apr 1912 (♂), Joannis, MHNP. Puebla de Don Fabrique, Granada Prov., 24 May 1929 (♂), Schmidt, IEEM. Cuenca, Cuenca Prov., no date (♀), MGAB.

Switzerland: Ofen, no date (3♂, ♀), MGAB.

Syria: "Syrie," no date (♀), Joannis, MHNP. Damascus, 20 Mar 1962 (2 ♀), NHMV. Ghaziv, no date (5 ♂), Joannis, MHNP.

Turkey: Beyschir golii, 4 Jun 1954 (4 ♂), J. Klimesch, 1100 m, JK. "Brussa" (=Bursa, Prov. Bursa), 1851 (3 ♂, ♀), NHMV; Mar 1878 (2 ♂), Zeller, BMNH. "Taurus," no date (6 ♂), IEEM.

USSR: Belbek, Crimea, Ukrainian SSR, no date, ZIL (Diakonoff, in press). "Sarepta" (=Krasnoarmeysk), Volgograd, Russia SSR, no date, ZIL (Diakonoff, in press); Nov 1860 (♂, 4♀), Christoph, BMNH.

Yugoslavia: Gravosa, Dalmatia, Croatia, 28 May 1908 (♀), NHMV. Istra Peninsula, Croatia, 1893 (♂), NHMV. Ohrid, Macedonia, Sep 1954 (♂), F. Kasy, NHMV. "Slovenia," no date (♀), NHMV.

Not every available specimen of this species has been searched for in the museums of the world, but the above specimens comprise the holdings of the larger collections. In his palearctic revision Diakonoff (in press) studied available specimens and noted the same maximum distribution for the species as below.

DISTRIBUTION (Figure 2).—Morocco north to Poland, east to Southern Russia and Israel.

FLIGHT PERIOD.—March to December in the south; April to November in the north. Overlapping voltinism; at least two generations in the north (Toll, 1938:164).

HOST.—*Aristolochia clematitis* Linnaeus and *Aristolochia pistolochia* Linnaeus (Aristolochiaceae) (Hering, 1957:114).

BIOLOGY.—The larvae are gregarious leaf miners of *Aristolochia* and make irregular blotch-like mines (Figure 37) on the dorsal surface of the leaves, with several larvae occupying one leaf mine. This larval behavior and biology is unique in the family as far as is known, although communal larvae are known in the hollow-stemmed host plants of *Tebenna carduiella* (Kearfott) from the United States. Except for the other Millieriinae, typical Choreutidae are leaf skeletonizers.

Pupation is within a lentil-shaped pupal case formed within the leaf mine. Millière (1856:39) gave the first description of the biology of this species. The biology or rearing record has also been noted by Hartmann (1880:54), Hering (1927:34, 1957:114), Spuler (1910:298), and Toll (1938:164). The species is bivoltine in Poland (Toll, 1938), but collection records do not show any clear generations further south, only overlapping generations.

REMARKS.—Adults of *M. dolosana* cannot be mistaken for any other choreutid from Europe. Of the choreutid genus *Caloreas* from the New World, there are only a few species that also have white hindwings. The genitalia are very distinct in Millieriinae, especially in the unique scaphium of the male. In the female the signum easily distinguishes the species. The species is very widespread in Europe and appears to be relatively common wherever the host plant occurs.

***Phormoestes*, new genus**

TYPE-SPECIES.—*Phormoestes palmettovora*, new species.

ADULT.—Small moths, 3.2–4.0 mm forewing length.

Head (Figure 5): Vertex and frons vestiture smooth. Labial palpus smooth scaled; basal and middle segments subequal; apical segment somewhat shorter. Haustellum scaled basally. Maxillary palpus (Figure 6) small, 1-segmented (possibly 2-segmented), with basal area wide and apical segment bulbous. Pilifer large. Eye moderate. Ocellus small. Antenna filiform, flattened with dense setae. Caudal end of head (Figure 10) with tentorial bridge subtending large round upper opening from smaller subquadrate lower opening with prominent occipital condyli.

Forewing (Figure 13): Shape elongate with somewhat pointed apex; rounded tornal and anal margins. Pterostigma small, from Sc to Rs. Sc to midwing on costal margin. R₁ to middle of pterostigma. R₂ to distal end of pterostigma. R₃-R₅ evenly spaced from end of chorda and cell. Chorda present. Cell 3/4 length of wing, without vestigial median vein evident. M₁ close to R₅ at cell. M₁-M₃ evenly spaced. CuA₁ almost parallel to CuA₂, divergent from near end of cell. CuP present at tornal margin. A₁₊₂ with long basal fork; A₃ vestigial.

Hindwing: Shape subtriangular, with rounded but slightly truncate anal margin. Apex somewhat pointed. Sc to 3/4 from base. Rs to near apex. Cell 1/2 wing length, with vestigial median vein present. M₁ to apex; M₁-M₃ evenly spaced; M₃ separate from CuA₁. CuA₁ and CuA₂ widely separate and divergent from near end of cell. CuP present at tornus. A₁₊₂ with moderate basal fork. A₃ long and stout; A₄ 1/2 length of A₃.

Abdomen: Normal. Coremata absent.

Male Genitalia: Tegumen fused to vinculum. Saccus small, articulated. Uncus present. Gnathos a sclerotized point with strong lateral arms. Socius absent. Valva simple. Anellus circular, convex, without lateral process. Aedeagus small, slender. Cornutus absent.

Female Genitalia: Ovipositor of normal length, with setaceous papilla analis. Apophyses normal. Ostium simple, without sterigma. Ductus bursae membranous. Corpus bursae simple. Signum absent.

LARVA (Figures 42-50).—Head (Figures 43-44)

hypognathous; frontoclypeus only 1/2 distance to epicranial notch. Stemmata in rectangular semi-circle. Proleg short; crochets (Figure 45) in circle, biordinal. Prothorax with sclerotized dorsal shield; L-group bisetose on one pinaculum (trisetose on meso- and metathorax); SD2 distant to SD1; SV setae approximate on one pinaculum. Meso- and metathorax with L1 close to L2 and distant from L3; SD2 on mesothorax greatly elongated. Abdominal segment A2 with SV setae in oblique triangle; abdominal segments A1-8 with SD2 minute and equidistant with SD1 to spiracle; L2 approximate and anteroventrad to L1; D2 setae slightly more apart than D1 setae, except on segment A8-9 where D2 setae are closer together than D1 setae.

PUPA (Figures 51-53).—Head with blunt projection on front. Maxillary palpus prominent. Legs free at wing tips. Dorsal abdominal spines present in wide diffuse band composed of two rows on tergites A2-7 in males (A2-6 in females), with the two rows becoming more distinct progressively posteriorly; single band of spines on tergites A8-9. Abdominal segments A3-7 in males (A3-6 in females) movable. Cremaster not evident except for somewhat hook-tipped setae on posterior end (Figure 53). Pupation in a hollow flower pod (Figure 54) with flap-like opening; attached to ventral side of leaf of host along leaflet midrib; pupa extruded at adult eclosion.

REMARKS.—*Phormoestes* is a very curious genus of Choreutidae. At first view it appears more like an oecophorid, yet it does not conform morphologically to this family. The wing venation, head morphology, and immature characters conform to the basic characteristics of Choreutidae. This genus is very different from *Millieria* in many characters yet shows basic similarities. The wing venation of the two genera are quite similar, the only major difference being the stalked M₃ and CuA₁ veins of the hindwing of *Millieria*, which is also unusual for the family as a whole. The head morphology of *Phormoestes* shows considerable derivation from the *Millieria* line, with less lateral compound eyes and labial palpi having more subequal segments and a reduced ventral scale

tuft. The maxillary palpi appear to be 1-segmented, but the base may be another segment almost fused to the galaea. The morphology of the caudal end of the head shows more similarities to the new genus from Chile, especially in the prominence of the occipital condyli, which are not evident in *Millieria*. The genitalia of *P. palmettovora*, especially the male genitalia, are very distinctive, notably the tubular tegumen-vinculum and the strong uncus and gnathos.

The larva of *Phormoestes* is very similar to that of *Millieria* in basic characters. The biordinal crochets of the prolegs are most distinctive for *Phormoestes*, being uniordinal in all other Choreutidae. However, in other characters the larvae are more similar to other choreutids than are larvae of *Millieria*.

The pupa is also very distinctive and appears considerably derived from the more primitive state found in *Millieria*.

ETYMOLOGY.—The name *Phormoestes* is Greek for "basket dweller," referring to the pupal case.

Phormoestes palmettovora, new species

ADULT MALE (Figure 17).—3.3–4.0 mm forewing length.

Head: Vestiture silvery gray, with white eye border on frons. Labial palpus silvery gray, small. Antenna thickened, dark gray, slightly more than 1/2 wing length.

Thorax: Dark gray vestiture. Patagia silvery gray. Venter gray. Legs silvery gray with white stripes on tarsal segments.

Forewing: Silvery gray on basal 1/3, midwing vertical fascia, and much of apical 1/4, with occasional green or purple iridescence; areas between silver regions are iridescent black, with curved white line bordering basal silver area; straight white vertical line almost bordering midwing silver area; two white costal marks near apex; one white tornal mark. Fringe black, with an outer layer of silvery gray. Ventral side lustrous gray.

Hindwing: Color uniform lustrous gray.

Fringe silvery gray, becoming white along anal margin. Ventral side lustrous gray.

Abdomen: Color silvery gray dorsally and ventrally.

Male genitalia (Figure 38): Tegumen and vinculum fused, strongly sclerotized. Saccus a small narrow, articulated appendage. Uncus a strongly sclerotized triangular projection coming to a blunt apex. Socius absent. Gnathos strongly sclerotized, with 2 upwardly curved lateral arms fused to blunt apex with fine dorsal dentations. Valva simple, narrow-oblong with setal field on apical 1/4, slightly curved upward to rounded apex. Anellus convex, rounded with dorsal notch and a straight ventral edge. Aedeagus (Figure 39) narrow, elongate, without phallobase. Cornutus not evident.

FEMALE (Figure 18).—Similar to male.

Female Genitalia (Figure 40): Normal ovipositor, with setaceous papilla analis. Apophyses subequal in length, somewhat stout. Ostium (Figure 41) a simple opening with a sclerotized cup; no sterigma evident. Ductus bursae membranous, narrow, gradually merging into bursa. Ductus seminalis from midpoint between ostium and widest area of bursa. Corpus bursae simple, elongate-ovate, without signum.

Larva and pupa as described for the genus.

TYPE.—Holotype ♂, USNM 100235.

TYPE-LOCALITY.—Florida: Archbold Biological Station, Highlands Co., 3 Apr 1959, R.W. Hodges, USNM slide 77146.

PARATYPES (31♂, 6♀).—Florida: *Alachua Co.:* Gainesville, no date (♂), A. Peterson, ex *Sabal palmetto*, FSCA. San Felasco Hammock, Alachua, 2 May 1977 (♀), G.B. Fairchild and H.V. Weems, Jr., FSCA. *Gulf Co.:* 2 mi (3.2 km) E McNeils, 18 Mar 1974 (♂), J.B. Heppner, JBH. *Highlands Co.:* Archbold Biological Station, 29 Mar 1959 (♀), R.W. Hodges, USNM; 7 Apr 1963 (♀), S.W. Frost, USNM; 14 Apr 1979 (♂), H.V. Weems, Jr., and S. Halkin, FSCA; 2 May 1975 (2♂), 9 May 1975 (♀), J.B. Heppner, JBH. *Levy Co.:* Cedar Key, 5 May 1981 (♂, ♀), 6 May 1981 (24♂), on *Sabal palmetto* flowers, J.B.

Heppner, JBH. *Sarasota Co.*: Siesta Key, 25 Apr 1953 (♀), C.P. Kimball, CPK.

DISTRIBUTION (Figure 2).—Known only from Florida.

FLIGHT PERIOD.—March to May.

HOST.—*Sabal palmetto* (Walter) Loddiges (Palmae).

BIOLOGY.—Alvah Peterson was the first to rear this species and in doing so to discover the species. Unfortunately he did not publish anything on the biology. The larvae are found boring within the minute flower pods of the sabal palm inflorescence. Thus, this feeding behavior would appear to enforce a reduced period of adult activity per year, since the palms only bloom from spring to early summer. Indeed the collection records for adults are only from March to early May. After sufficient feeding, the larvae apparently take one of the hollowed out flower pods and form a pupal case, having a flap on the distal end, and transport this case to the ventral side of one of the large palm leaves. The pupal case (Figure 54) is attached to the midrib of one of the many leaflets of the palm leaf. Although thus far not confirmed, it would appear that larvae (or pupae) overwinter in the pupal case and adults of the first generation emerge the following March, when the palms are again producing inflorescences. It is conceivable that over the period from March until May and possibly to early July, there could be two, perhaps even three generations, but this remains uncertain. However, freshly emerged adults have been taken in each of the three months from March until May.

REMARKS.—This is the only known species of *Phormoestes*. Although the host plant and the general appearance of the moths indicates a tropical element of the Florida fauna, no related moths are known in the neotropics except for the new species from Chile, which is a very isolated south temperate species. The genital morphology, in addition to wing coloration, will easily distinguish the species from the Chilean species or any other moth from Florida. The only diurnal Florida moth that has a remote resemblance to *P. palmettorora* is the unrelated *Neomachlotica spiraea*

Heppner of the family Glyphipterigidae, but close examination will easily distinguish the two.

Nyx, new genus

TYPE-SPECIES.—*Nyx puyaphaga*, new species.

ADULT.—Small moths, 3.8–5.0 mm forewing length.

Head (Figure 7): Vertex and frons vestiture smooth. Labial palpus short, slightly upcurved, relatively smooth scaled; segments subequal. Haustellum scaled at base. Maxillary palpus (Figure 8) minute, 1-segmented with long distal seta. Piliifer large. Eye moderate. Ocellus small. Antenna filiform. Caudal end of head (Figure 11) with tentorial bridge subtending large ovate upper opening from small subquadrate lower opening, with prominent occipital condyli.

Thorax: Normal. Legs with normal tibial spurs.

Forewing (Figure 14): Shape elongate, with somewhat pointed apex; evenly rounded tornal and anal margins. Pterostigma not very prominent, small, from Sc to R₃. Sc to 2/3 wing length. R₁ to 3/4 from base; R₂ separate; R₃ stalked with R₄ directly at their base; R₅ free, to apex. Chorda absent. Cell 3/4 wing length, with vestigial median vein present. Median veins evenly spaced. CuA₁ and CuA₂ divergent; CuA₂ from near end of cell. CuP present at tornal margin. A₁₊₂ with moderate basal fork; A₃ vestigial.

Hindwing: Shape elongate, with pointed apex and slight convexity along anal margin. Sc to 3/4 from base. Radius to near apex. Cell to 2/3 wing length, with vestigial vein slightly evident. M₁ to apex, near to Rs at end of cell; M₁ to M₃ evenly spaced. CuA₁ and CuA₂ divergent, with CuA₂ from near end of cell. CuP present at tornal margin. A₁₊₂ fork 1/2 length of vein, A₃ almost subequal to A₁₊₂ in length; A₄ short.

Abdomen: Normal. Coremata present beneath 8th sternite and with opening for eversion on intersegmental membrane between sternites 7 and 8.

Male Genitalia: Tegumen fused to vinculum. Saccus vestigial. Uncus present. Gnathos a blunt

point with a recurved surface and strong lateral arms. Socius absent. Valva simple. Anellus a projected half-tube supporting aedeagus, without lateral process. Aedeagus very long, narrow, with apical denticious spines. Cornutus absent.

Female Genitalia: Ovipositor very long, with strongly sclerotized and sharp papilla analis. Apophyses very long and stout. Ostium simple, without a sterigma; 8th tergite with strong blade-like posterior projection. Ductus bursae membranous. Corpus bursae simple. Signum of small spines at ductus juncture with bursa.

Larva and pupa unknown.

REMARKS.—*Nyx* appears to be the most specialized member of the Millieriinae, with the modified ovipositor of the female being most derived and apparently designed to penetrate the host plant for egg deposition. The head and genital morphology of the genus point to a close relationship to *Phormoestes*, while the reduced maxillary palpus and loss of the chorda show a derived state. This is the first known choreutid genus with abdominal coremata.

ETYMOLOGY.—The generic name *Nyx* is derived from Greek for "puncture," referring to the sharp ovipositor of the type-species females.

Nyx puyaphaga, new species

ADULT MALE (Figure 19).—3.8–4.5 mm forewing length.

Head: Vestiture black-fuscous, with some white along eye margin and at base of frons. Labial palpus black-fuscous irrorated with white; small scale tuft.

Thorax: Color black-fuscous. Patagia black-fuscous with white on posterior tip. Venter white with some fuscous. Legs fuscous and white, merging to pure white on the ends of all segments.

Forewing: Ground color black-fuscous irrorated with white except for solid vertical blackish band at 1/3 from base, followed distally by white vertical, slightly curved line; white mark at tornus, continued irregularly toward costal margin; fringe fuscous with white tips. Ventral side fus-

cous with white over anal field and partly in cell near base.

Hindwing: Color lustrous white with fuscous along costal margin; fringe white except for fuscous at apex. Ventral side similar to dorsal surface.

Abdomen: Color black with white rings on each segment. Venter white.

Male Genitalia (Figure 55): Tegumen fused to vinculum to form a strongly sclerotized tube with anterior dorsal apodemes and slightly ventral saccus. Uncus a strongly sclerotized triangular projection with a notched apex. Gnathos two strongly sclerotized lateral arms fused to an up-curved blunt point with a recurved denticious dorsal surface (Figure 56). Valva simple, short with an oblique rounded apex having a setal field on apical 2/5 of valva. Anellus (Figure 56) a strongly sclerotized projecting concave support for aedeagus. Aedeagus (Figure 57) very long and slender (somewhat longer than total tegumen-vinculum-valval length combined); aedeagus with denticious scrobations near apex (Figure 58). Cornutus not evident.

FEMALE (Figure 20).—Similar to male; size 4.0–5.0 mm forewing length. Hindwing white as in male in most cases, but one specimen is known with a fuscous hindwing.

Female Genitalia (Figure 59): Ovipositor very long (subequal to abdomen length). Papilla analis (Figure 60) blunt-pointed with fine scrobations on sharp edges near apex; strongly sclerotized; spirales of fine, sharp denticious spines on segment 10 (Figure 61). Apophyses extremely long (filling most of abdomen when retracted), thick and stout; anterior and posterior pair subequal. Ostium (Figure 62) a simple funnel; 8th tergite with an elongated and sharply pointed dorsal projection, strongly sclerotized. Ductus bursae membranous, narrow, short (1/3 ovipositor length). Ductus seminalis emergent from middle of ductus bursae, with a small sclerotized ring below entrance of ductus seminalis. Corpus bursae an elongated sack with dense scrobations on inner wall; a small ring of sharp spines (ca. 15–

20) at entrance to bursa (Figure 63) and directed anteriorly; no other signum evident.

TYPE.—Holotype ♂, USNM 100234.

TYPE-LOCALITY.—Chile: Angol, Malleco Prov., 5 Dec 1927, D.S. Bullock, ex *Puya alpestris*, USNM slide 77908.

PARATYPES (9 ♂, 21 ♀).—Chile: Malleco Prov., Angol, 7 Nov 1928 (5 ♂, 16 ♀), 14 Nov 1929 (♂, ♀), 16 Nov 1929 (2 ♂, ♀), 5 Dec 1927 (♂, ♀), 10 Dec 1928 (♀), 17 Dec 1927 (♀), D.S. Bullock, ex *Puya alpestris*, USNM.

DISTRIBUTION (Figure 2).—Known only from central Chile.

FLIGHT PERIOD.—November to December.

HOST.—*Puya alpestris* (Poeppig) Gay (Bromeliaceae).

BIOLOGY.—The species was reared by D.S. Bullock in Chile, who thus obtained the only known specimens. Unfortunately, associated pupal shells and possibly larval specimens have become misplaced over the years and could not be located

for this study. The female genitalia clearly show that the eggs must be inserted into the host plant, since the ovipositor is extremely stout and sharply pointed. It is not known into which part of the plant the egg is inserted or on what part the larva actually feeds. The host plant is one of the large yucca-like Chilean bromeliads.

REMARKS.—This species is very distinctive in external appearance and in genital characters. No known moth from Chile has any resemblance to it. The distribution of the host plant would also indicate that *N. puyaphaga* should not be found outside of Chile and the southern Andes Mountains. As noted in the description, one female paratype has dark hindwings; none of the males show such melanism. Chile has numerous species of *Puya*, as well as related bromeliads; thus it is possible that there are other members of the genus yet to be found on other species of bromeliads in this area of South America, which is relatively uncollected for microlepidoptera.

Literature Cited

- Desmarest, E.
[1857]. Papillons nocturnes. In J.C. Chenu, *Encyclopédie d'histoire naturelle ou traité complet de cette science d'après les travaux des naturalists les plus éminents de tous les pays et de toutes les époques*, 10: 312 pages, 39 plates. Paris: Havard.
- Diakonoff, A.N.
In press. Glyphipterigidae sensu lato. In H.G. Amsel, F. Gregor, and H. Reisser, editors, *Microlepidoptera Palaearctica*. Vienna: G. Fromme.
- Fettig, A.
1882. Microlépidoptères. In H. de Peyerimhoff, Catalogue des lépidoptères d'Alsace. . . . *Bulletin de la Société Histoire Naturelle de Colmar*, 22/23:34–214.
- Hartmann, A.
1880. *Die Kleinschmetterlinge des europäischen Faunengebietes. Erscheinungszeit der Raupen und Falter, Nahrung und biologische Notizen*. 182 pages. Munich: T. Ackermann.
- Heppner, J.B.
1977. The Status of the Glyphipterigidae and a Reassessment of Relationships in Yponomeutoid Families and Ditrysiac Superfamilies. *Journal of the Lepidopterists' Society*, 31:124–134.
- Heppner, J.B., and W.D. Duckworth
1981. Classification of the Superfamily Sesioidea (Lepidoptera:Ditrysiac). *Smithsonian Contributions to Zoology*, 314:1–144.
- Hering, E.M.
1927. 24. Ordnung: Schmetterlinge, Lepidoptera. In P. Brohmer, P. Ehrmann, and G. Ulmer, editors, *Die Tierwelt Mitteleuropas*, 6(3):1–34. Jena.
1957. *Bestimmungstabellen der Blattminen von Europa*. 3 volumes, 1185 pages, 221 plates. The Hague: W. Junk.
- Herrich-Schäffer, G.A.W.
1854. Die Schaben und Federmotten. In G.A.W. Herrich-Schäffer, *Systematische Bearbeitung der Schmetterlinge von Europa, zugleich als Text, Revision und supplement zu Jakob Hübner's Sammlung europäischer Schmetterlinge*, 5:73–224. Regensburg: G. J. Mang.
- Heydenreich, G.H.
1851. *Lepidopterorum Europaeorum catalogus methodicus: Systematisches Verzeichniss der europäischen Schmetterlinge*. Third edition, 130 pages. Leipzig: Klinckhart.
- Klimesch, J.
1968. *Die Lepidopterenfauna Mazedoniens, IV: Microlepidoptera*. 203 pages. Skopje: Prirodonaucen Muzej.
- Le Marchand, S.
1937. Tineina, Les Glyphipterigidae. *Amateur de Papillons (Revue Française de Lépidopterologie)*, 8:189–193.
- Millière, P.
1856. Histoire de *Choreutis dolosana*, Herr.-Sch. *dolosalis* F.-v.-R. *Annals de la Société Entomologique de France*, series 3, 4:39–49; 1 plate.
- Ragonot, E.L.
1874. Nouvelles especes françaises de microlépidoptères. *Bulletin de la Société Entomologique de France*, series 5, 4:171–173.
- Reutti, C.H.
1898. Übersicht der Lepidopteren-Fauna des Grossherzogtums Baden (und der anstossenden Länder). *Verhandlungen des Naturwissenschaftlichen Verein Karlsruhe*, 12:1–361, plate 1.
- Spuler, A.
1910. *Die Schmetterlinge Europas*. Volume 2, 523 pages. Stuttgart: E. Schweizerbart.
- Staudinger, O.
1870. Beitrag zur Lepidopteren Fauna Griechenlands. *Horae Societatis Entomologicae Rossicae*, 7:3–304, plates 1–3.
- Toll, S.
1938. Verzeichnis der in den Jahren 1934–1937, in den Kreisen Zaleszchyski und Borszczow (Podolien) aufgefundenen Mikrolepidopteren. *Jahresbericht Physiographischer Kommission Polnische Akademie von Wissenschaften*, 72:133–221.
- Wocke, M.F.
[1876]. Kleinschmetterlinge, Band II: Die Motten und Federmotten. In H. von Heinemann and M.F. Wocke, *Die Schmetterlinge Deutschlands und der Schweiz*, 2(2):389–825. Braunschweig: Schwetschke.
- Zerkowitz, A.
1946. The Lepidoptera of Portugal. *Journal of the New York Entomological Society*, 54:51–87, 115–165, 211–261.

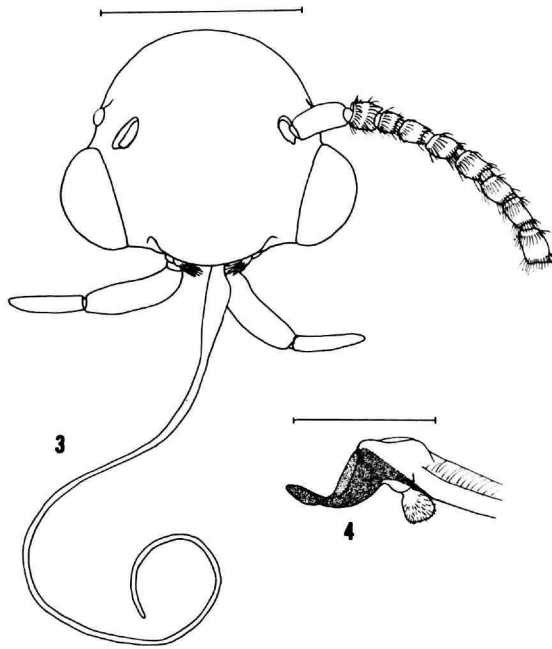

FIGURES 3-4.—Head morphology of *Milliera*: 3, front of head, ♂, USNM 77901 (scale = 0.5 mm); 4, detail of maxillary palpus (scale = 0.1 mm).

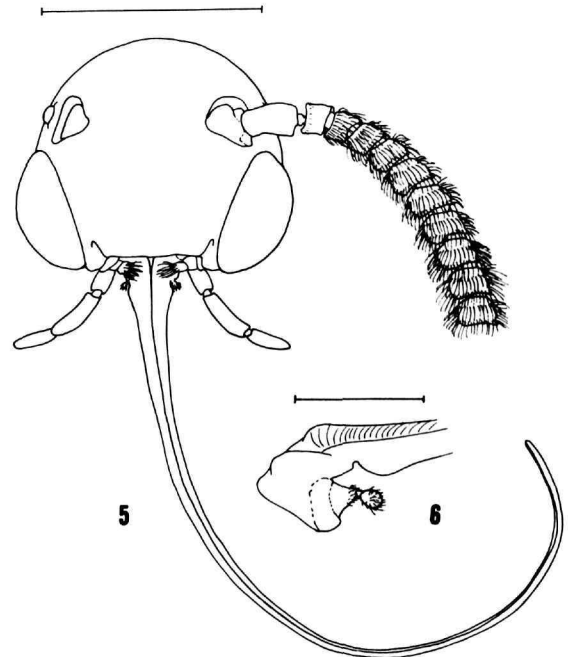

FIGURES 5-6.—Head morphology of *Phormoestes*: 5, front of head, ♂, USNM 77900 (scale = 0.5 mm); 6, detail of maxillary palpus (scale = 0.1 mm).

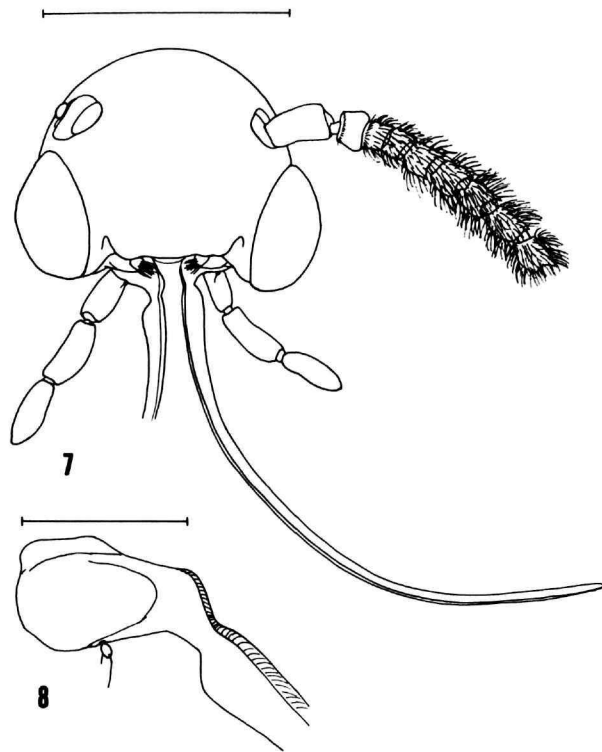

FIGURES 7-8.—Head morphology of *Nyx*: 7, front of head, ♂, USNM 77913 (scale = 0.5 mm); 8, detail of maxillary palpus (scale = 0.1 mm).

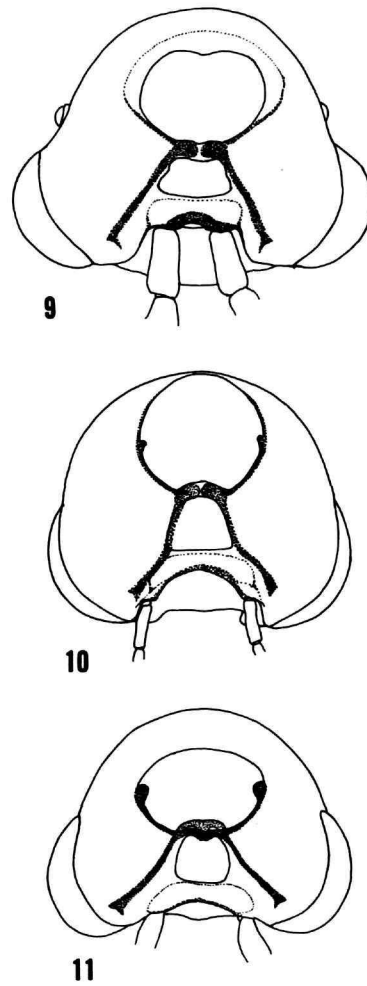

FIGURES 9-11.—Head morphology of Millieriinae, caudal end: 9, *Millieria*, ♂, USNM 77901; 10, *Phormoestes*, ♂, USNM 77900; 11, *Nyx*, ♂, USNM 77913.

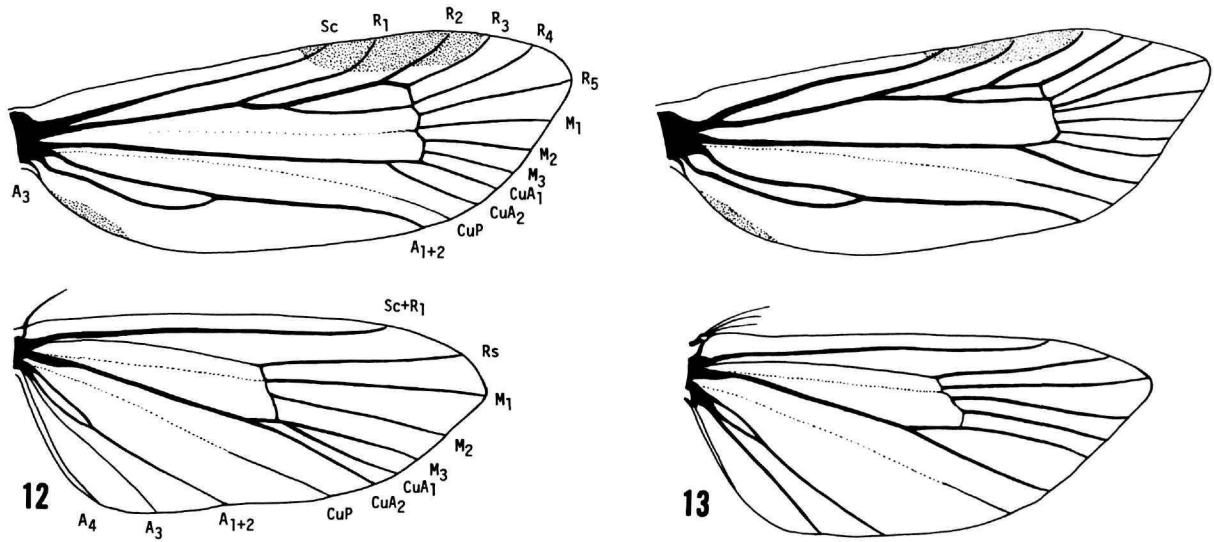

FIGURES 12-13.—Wing venation of Millieriinae: 12, *Millieria*, ♂, USNM 77216; 13, *Phormoestes*, ♀, JBH 668.

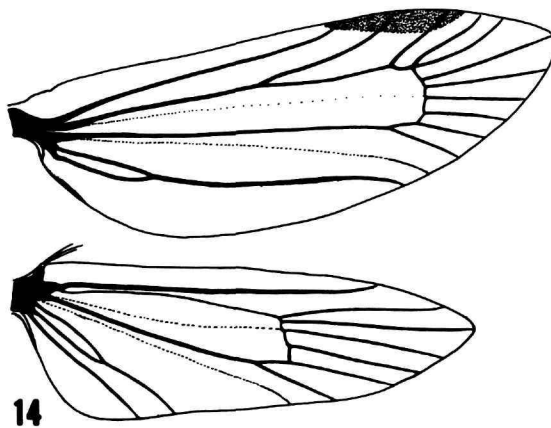
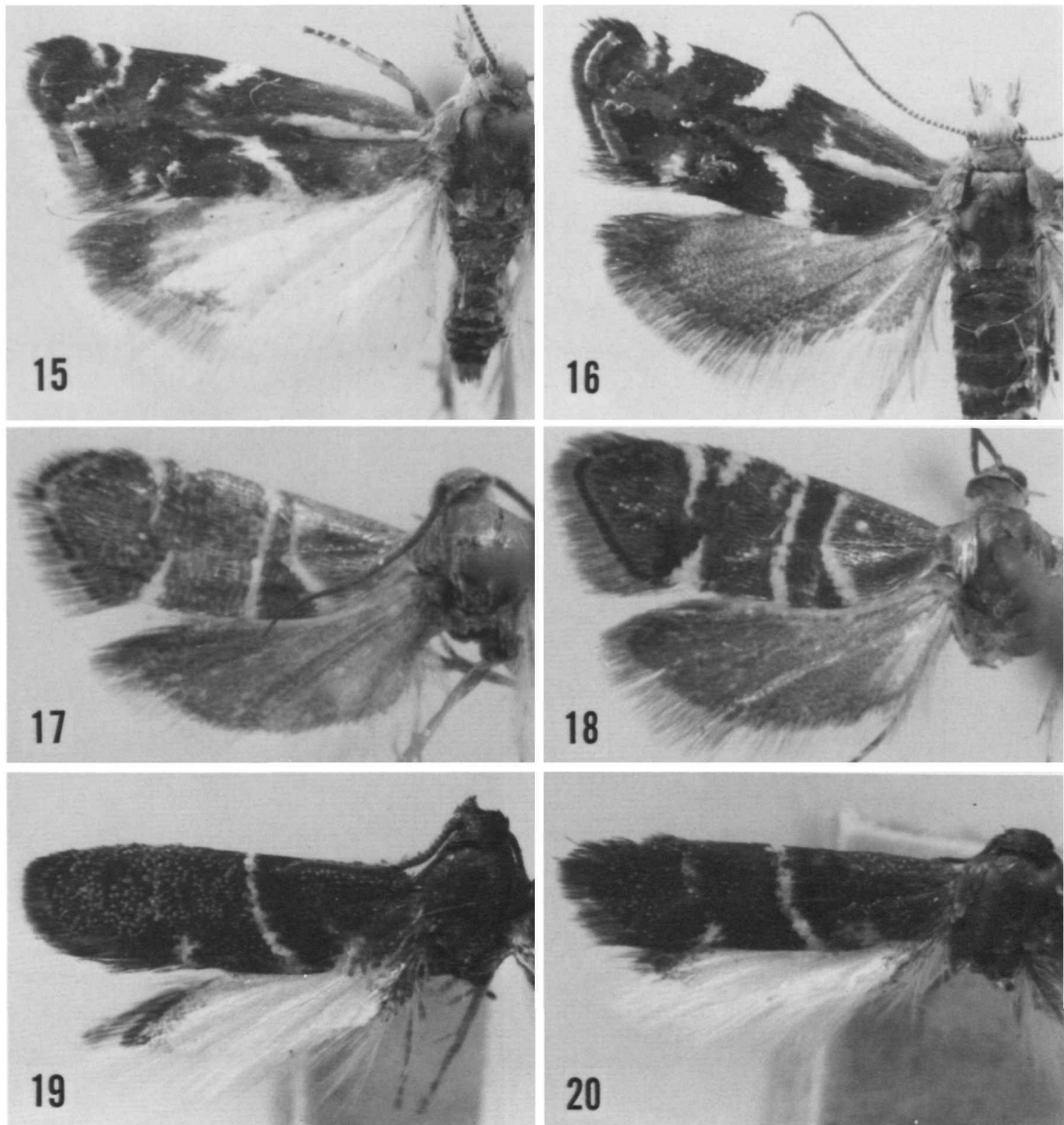
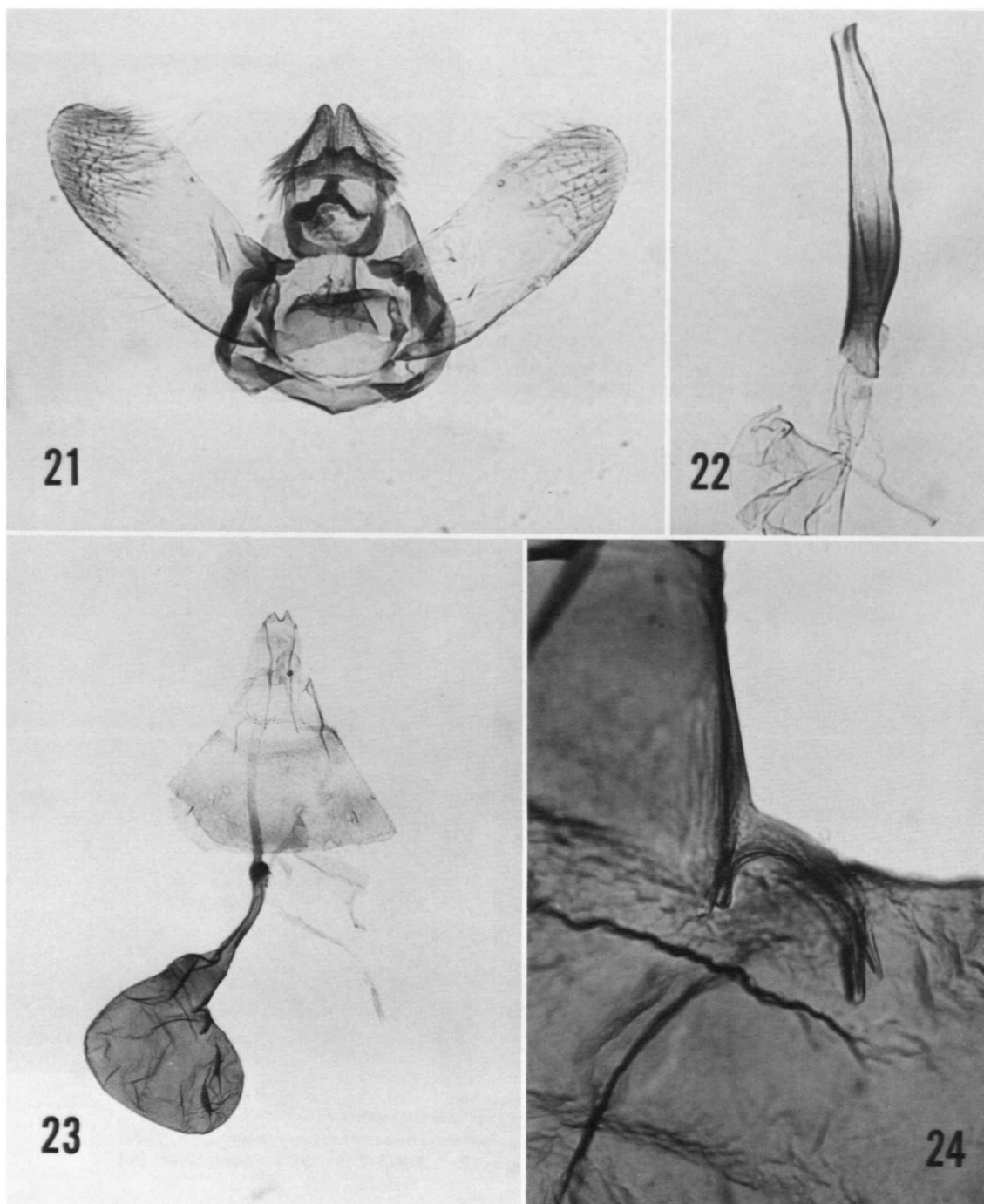

FIGURE 14.—Wing venation of *Nyx*, ♀, USNM 77912.



FIGURES 15-20.—Wing maculation of Millieriinae. *Millieria dolosana* (Herrich-Schäffer): 15, ♂, Paris, France; 16, ♀, Württemberg, Germany. *Phormoestes palmettovora*, new species: 17, ♂, Cedar Key, Florida; 18, ♀, *Nyx puyaphaga*, new species: 19, ♂, Angol, Chile; 20, ♀, Angol, Chile. (All USNM specimens).



FIGURES 21-24.—Genitalia of *Millieria dolosana* (Herrich-Schäffer): 21, ♂, Württemberg, Germany, JBH 140; 22, same, aedeagus (enlarged); 23, ♀, Württemberg, Germany, JBH 592; 24, same, detail of signum.

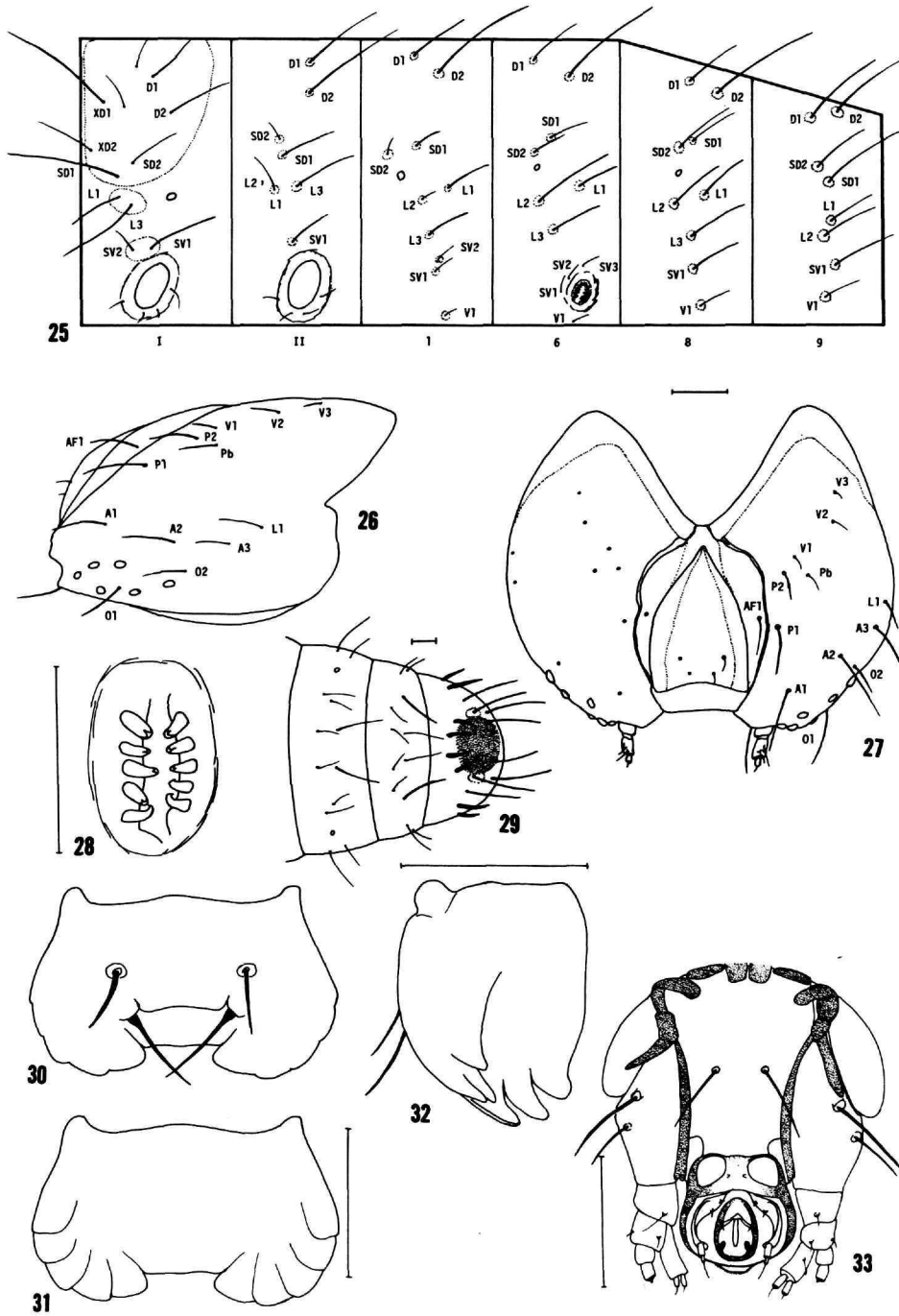

FIGURES 25-33.—Larval morphology of *Millieria dolosana* (Herrich-Schäffer); 25, chaetotaxy; 26, head, lateral view; 27, head, front view; 28, crochets; 29, caudal end of larva, dorsal view; 30, labrum, dorsum; 31, labrum, ventrum; 32, mandible, ventrum; 33, submentum, USNM 77897, Europe. (Scales = 0.1 mm.)

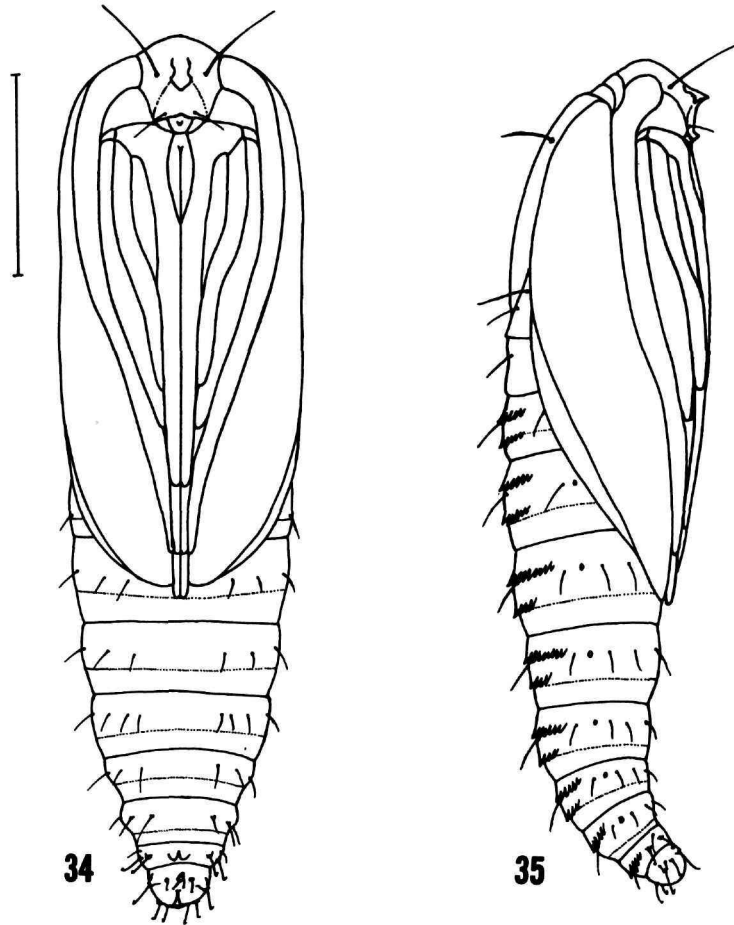

FIGURES 34-35.—Pupa of *Millieria dolosana* (Herrich-Schäffer), ♂, Europe, USNM: 34, front view; 35, side view. (Scale = 1.0 mm.)

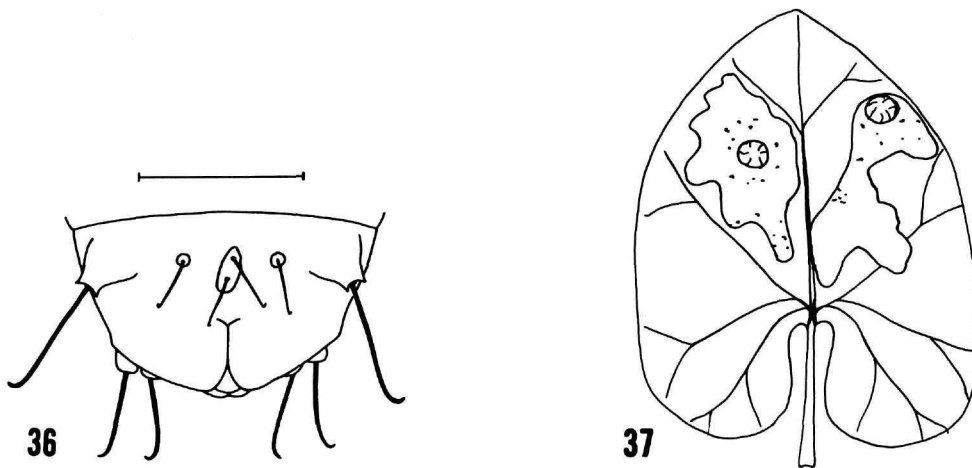
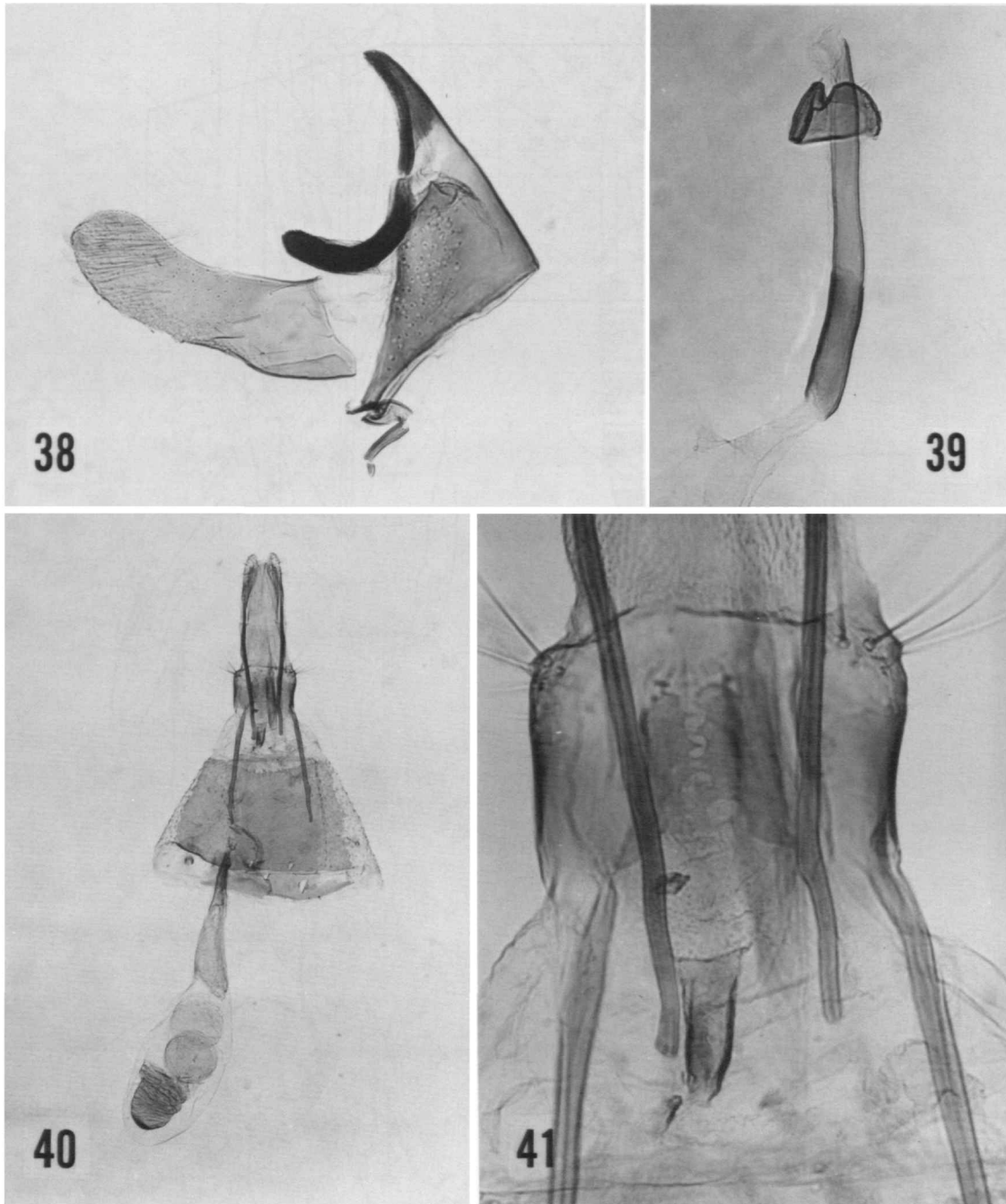
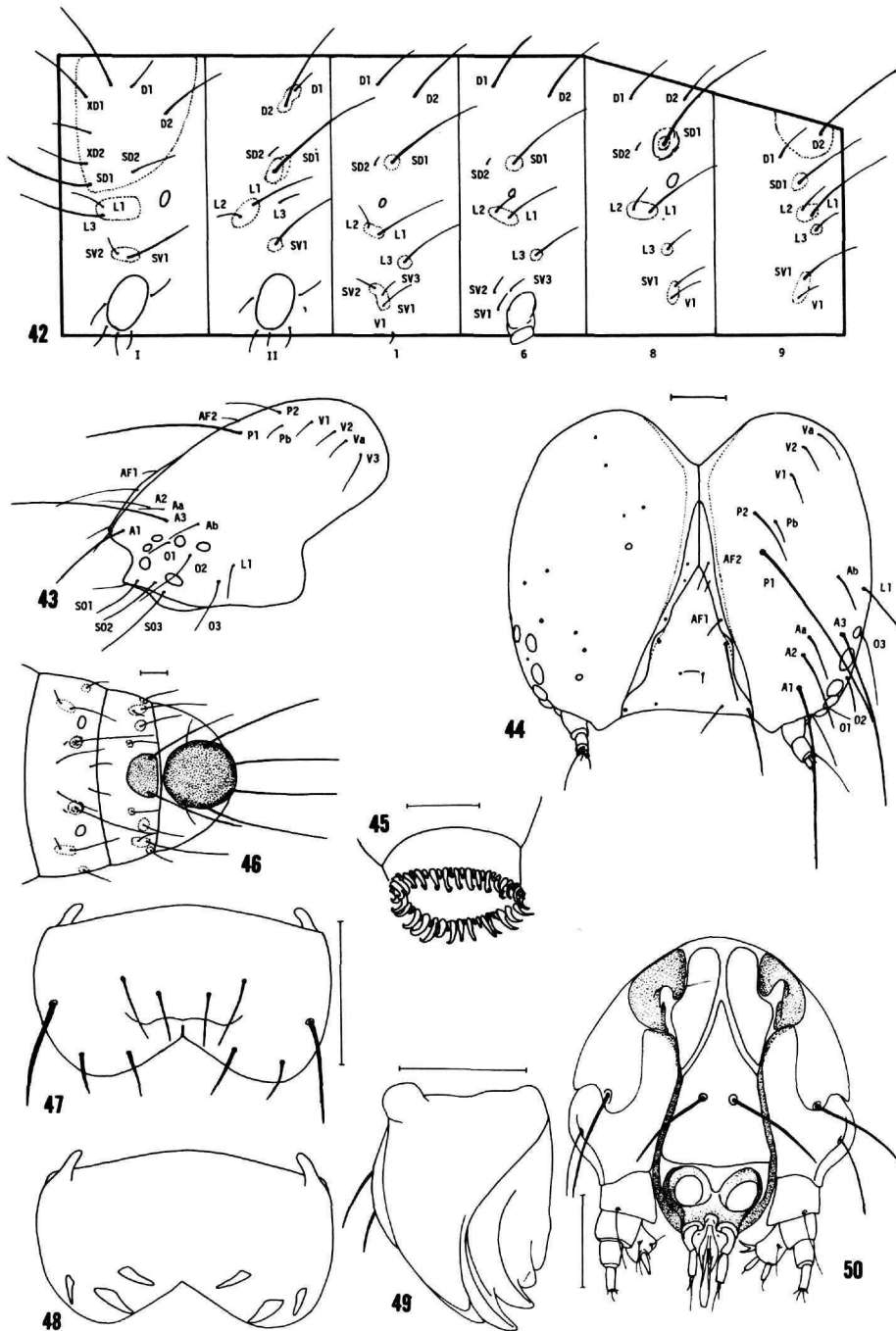

FIGURE 36.—Pupa of *Millieria dolosana* (Herrich-Schäffer), ventrum of ultimate segment (scale = 0.1 mm).

FIGURE 37.—Leaf mine of *Millieria dolosana* (Herrich-Schäffer) on *Aristolochia* host (from Hering, 1957, pl. 8: fig. 56).



FIGURES 38-41.—Genitalia of *Phormoestes palmettoora*, new species, Archbold Biological Station, Highlands Co., Florida: 38, ♂, holotype USNM 77146; 39, same, aedeagus (enlarged), with attached anellus; 40, ♀, paratype, USNM 77147; 41, same, detail of ostium area.



FIGURES 42-50.—Larval morphology of *Phormoestes palmettovora*, new species, Cedar Key, Florida JBH 1621: 42, chaetotaxy; 43, head, lateral view; 44, head, front view; 45, crochets; 46, caudal end of larva, dorsal view; 47, labrum, dorsum; 48, labrum, ventrum; 49, mandible, ventrum; 50, submentum. (Scales = 0.1 mm.)

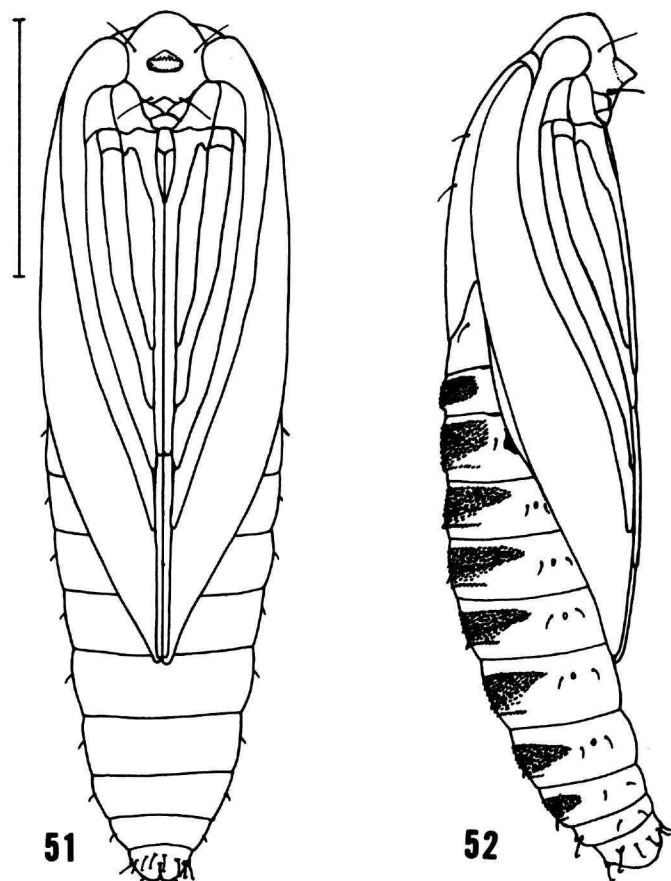

FIGURES 51-52.—Pupa of *Phormoestes palmettovora*, new species, ♂, Cedar Key, Florida: 51, front view; 52, side view. (Scale = 1.0 mm.)

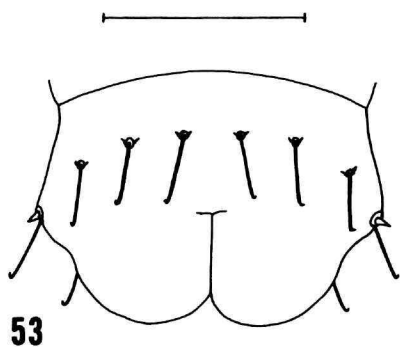

FIGURE 53.—Pupa of *Phormoestes palmettovora*, new species, ventrum of ultimate segment (scale = 0.1 mm).

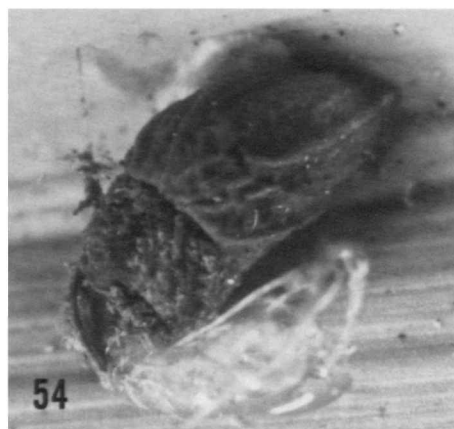
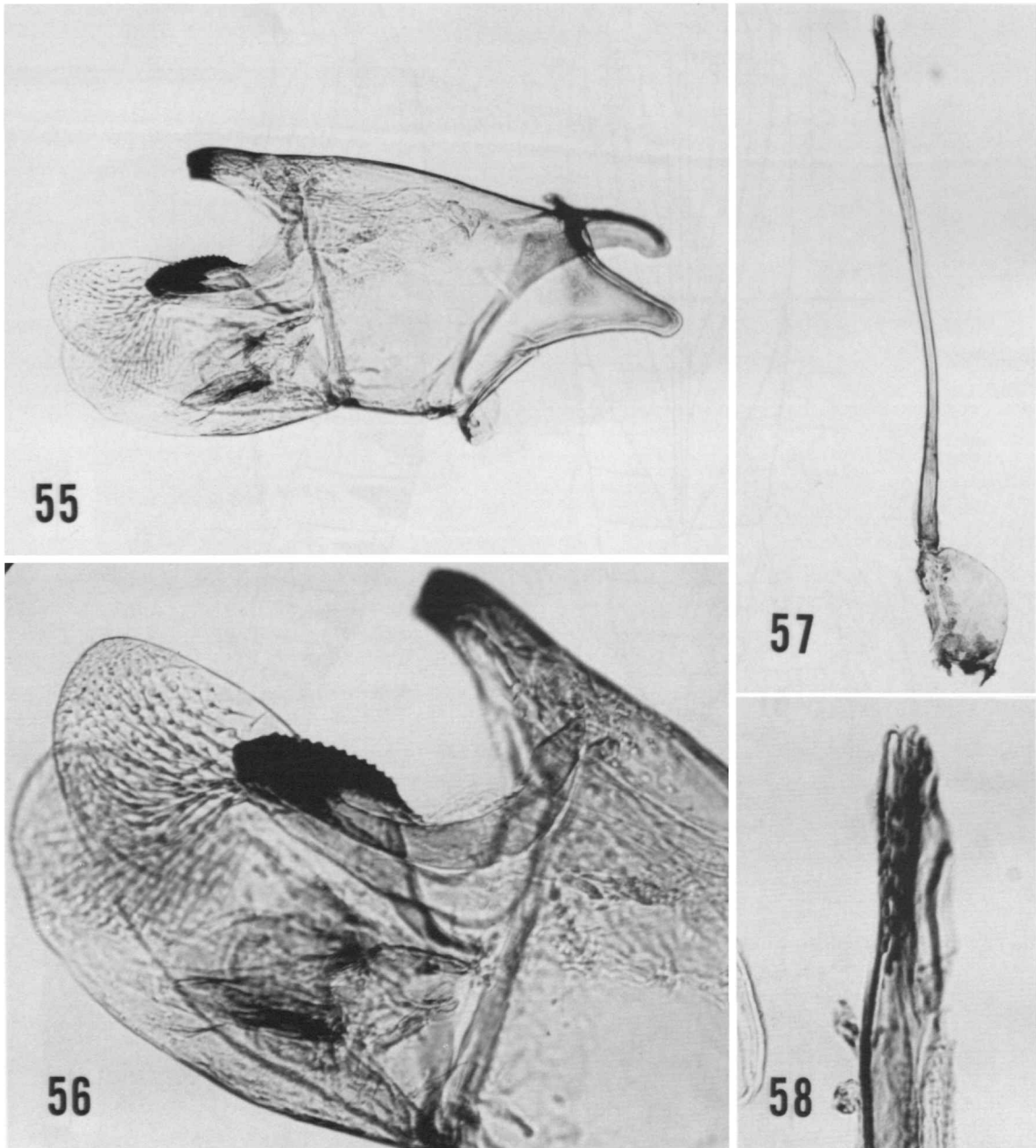
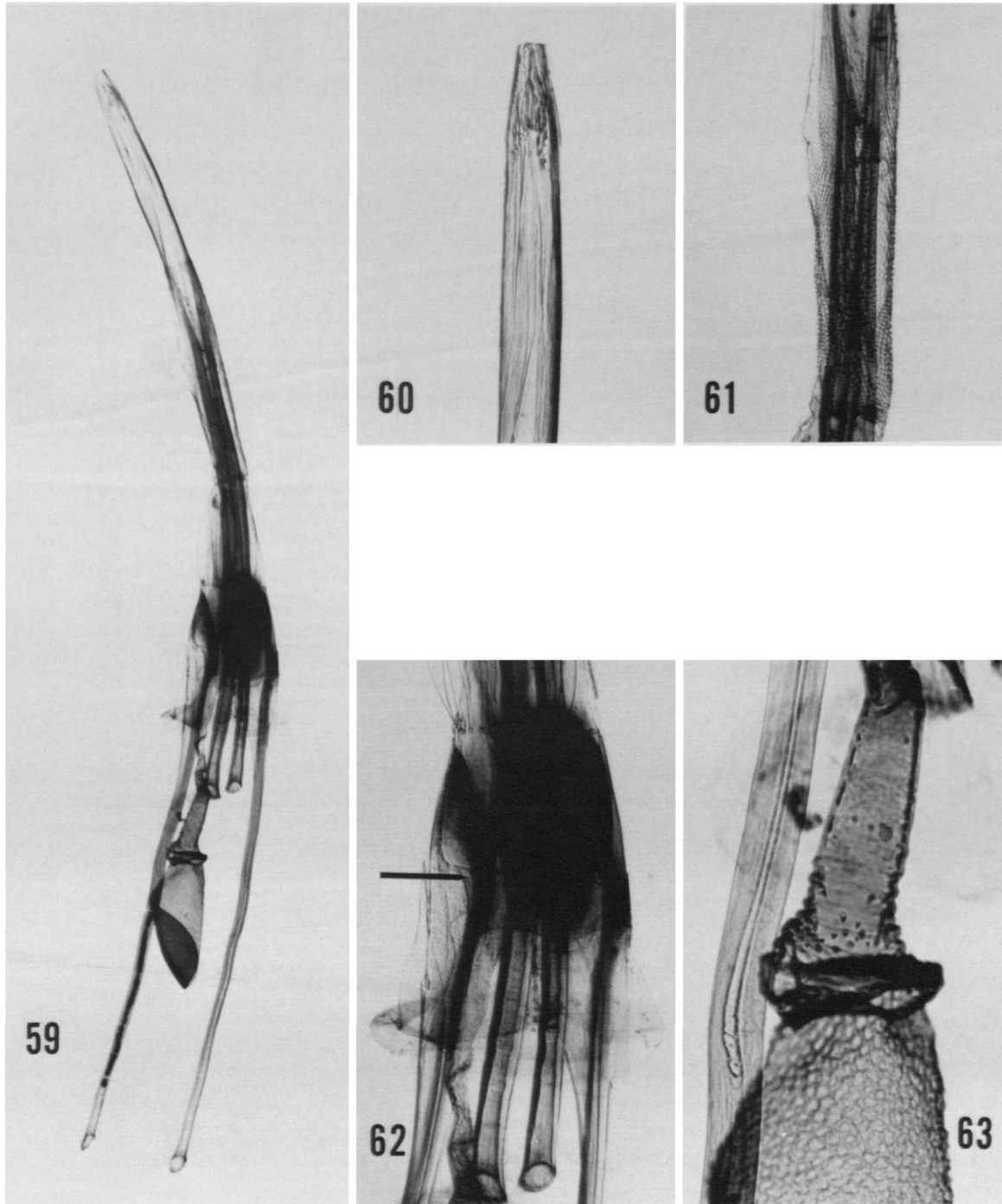

FIGURE 54.—Pupal case and protruded pupal shell of *Phormoestes palmettovora*, new species, on leaf of palm host, *Sabal palmetto*, Cedar Key, Florida.



FIGURES 55-58.—Male genitalia of *Nyx puyaphaga*, new species, Angol, Chile, USNM 77909: 55, ♂ paratype; 56, same, detail of uncus, gnathos, and valvae; 57, same, aedeagus (enlarged); 58, same, detail of aedeagus tip.



FIGURES 59-63.—Female genitalia of *Nyx puyaphaga*, new species: 59, ♀ paratype, Angol, Chile, USNM 77910; 60, same, detail of ovipositor tip; 61, same, detail of scrobinations on ovipositor; 62, same, detail of ostium area (arrow indicates ostium); 63, same, detail of signa.

REQUIREMENTS FOR SMITHSONIAN SERIES PUBLICATION

Manuscripts intended for series publication receive substantive review within their originating Smithsonian museums or offices and are submitted to the Smithsonian Institution Press with approval of the appropriate museum authority on Form SI-36. Requests for special treatment—use of color, foldouts, casebound covers, etc.—require, on the same form, the added approval of designated committees or museum directors.

Review of manuscripts and art by the Press for requirements of series format and style, completeness and clarity of copy, and arrangement of all material, as outlined below, will govern, within the judgment of the Press, acceptance or rejection of the manuscripts and art.

Copy must be typewritten, double-spaced, on one side of standard white bond paper, with 1 $\frac{1}{4}$ " margins, submitted as ribbon copy (not carbon or xerox), in loose sheets (not stapled or bound), and accompanied by original art. Minimum acceptable length is 30 pages.

Front matter (preceding the text) should include: **title page** with only title and author and no other information, **abstract page** with author/title/series/etc., following the established format, **table of contents** with indents reflecting the heads and structure of the paper.

First page of text should carry the title and author at the top of the page and an unnumbered footnote at the bottom consisting of author's name and professional mailing address.

Center heads of whatever level should be typed with initial caps of major words, with extra space above and below the head, but with no other preparation (such as all caps or underline). Run-in paragraph heads should use period/dashes or colons as necessary.

Tabulations within text (lists of data, often in parallel columns) can be typed on the text page where they occur, but they should not contain rules or formal, numbered table heads.

Formal tables (numbered, with table heads, boxheads, stubs, rules) should be submitted as camera copy, but the author must contact the series section of the Press for editorial attention and preparation assistance before final typing of this matter.

Taxonomic keys in natural history papers should use the aligned-couplet form in the zoology and paleobiology series and the multi-level indent form in the botany series. If cross-referencing is required between key and text, do not include page references within the key, but number the keyed-out taxa with their corresponding heads in the text.

Synonymy in the zoology and paleobiology series must use the short form (taxon, author, year:page), with a full reference at the end of the paper under "Literature Cited." For the botany series, the long form (taxon, author, abbreviated journal or book title, volume, page, year, with no reference in the "Literature Cited") is optional.

Footnotes, when few in number, whether annotative or bibliographic, should be typed at the bottom of the text page on which the reference occurs. Extensive notes must appear at the end of the text in a notes section. If bibliographic footnotes are required, use the short form (author/brief title/page) with the full reference in the bibliography.

Text-reference system (author/year/page within the text, with the full reference in a "Literature Cited" at the end of the text) must be used in place of bibliographic footnotes in all scientific series and is strongly recommended in the history and technology series: "(Jones, 1910:122)" or ". . . Jones (1910:122)."

Bibliography, depending upon use, is termed "References," "Selected References," or "Literature Cited." Spell out book, journal, and article titles, using initial caps in all major words. For capitalization of titles in foreign languages, follow the national practice of each language. Underline (for italics) book and journal titles. Use the colon-parentheses system for volume/number/page citations: "10(2):5-9." For alignment and arrangement of elements, follow the format of the series for which the manuscript is intended.

Legends for illustrations must not be attached to the art nor included within the text but must be submitted at the end of the manuscript—with as many legends typed, double-spaced, to a page as convenient.

Illustrations must not be included within the manuscript but must be submitted separately as original art (not copies). All illustrations (photographs, line drawings, maps, etc.) can be intermixed throughout the printed text. They should be termed **Figures** and should be numbered consecutively. If several "figures" are treated as components of a single larger figure, they should be designated by lowercase italic letters (underlined in copy) on the illustration, in the legend, and in text references: "Figure 9b." If illustrations are intended to be printed separately on coated stock following the text, they should be termed **Plates** and any components should be lettered as in figures: "Plate 9b." Keys to any symbols within an illustration should appear on the art and not in the legend.

A few points of style: (1) Do not use periods after such abbreviations as "mm, ft, yds, USNM, NNE, AM, BC." (2) Use hyphens in spelled-out fractions: "two-thirds." (3) Spell out numbers "one" through "nine" in expository text, but use numerals in all other cases if possible. (4) Use the metric system of measurement, where possible, instead of the English system. (5) Use the decimal system, where possible, in place of fractions. (6) Use day/month/year sequence for dates: "9 April 1976." (7) For months in tabular listings or data sections, use three-letter abbreviations with no periods: "Jan, Mar, Jun," etc.

Arrange and paginate sequentially EVERY sheet of manuscript—including ALL front matter and ALL legends, etc., at the back of the text—in the following order: (1) title page, (2) abstract, (3) table of contents, (4) foreword and/or preface, (5) text, (6) appendixes, (7) notes, (8) glossary, (9) bibliography, (10) index, (11) legends.

