

E  
171  
S664  
No.48  
NMAH

SMITHSONIAN  
LIBRARIES

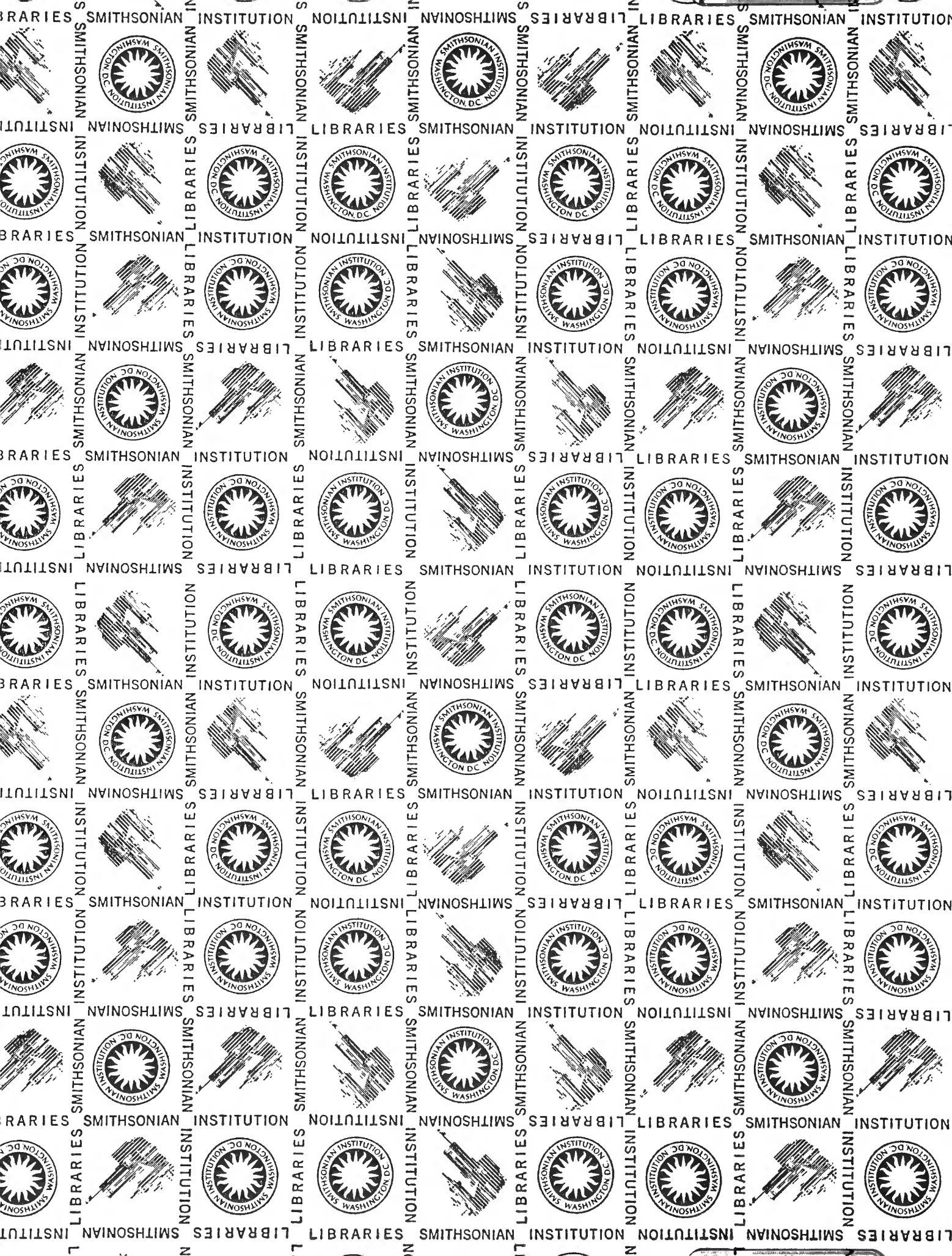

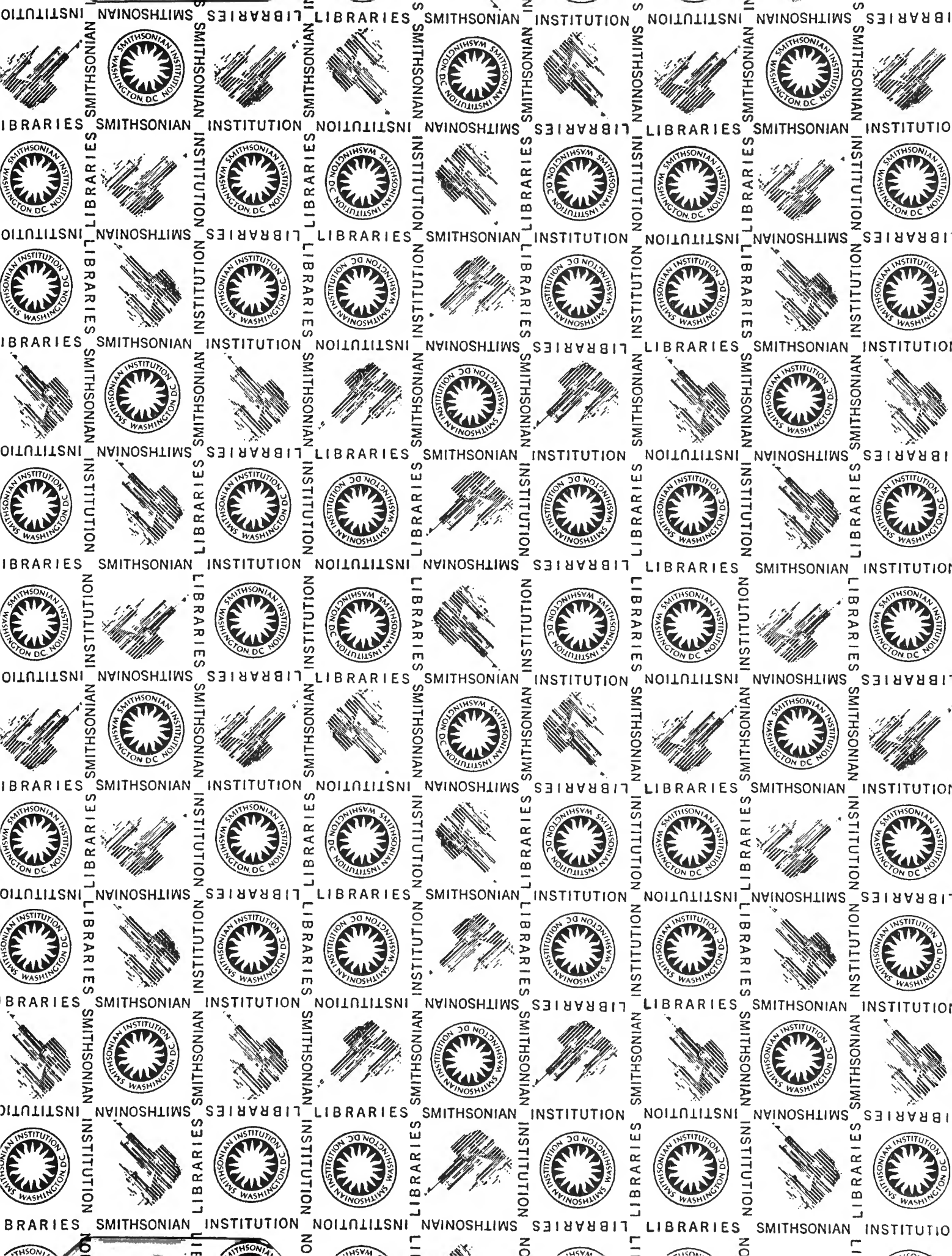







1  
566  
A 111

# A Brief History of Geomagnetism and A Catalog of the Collections of the National Museum of American History

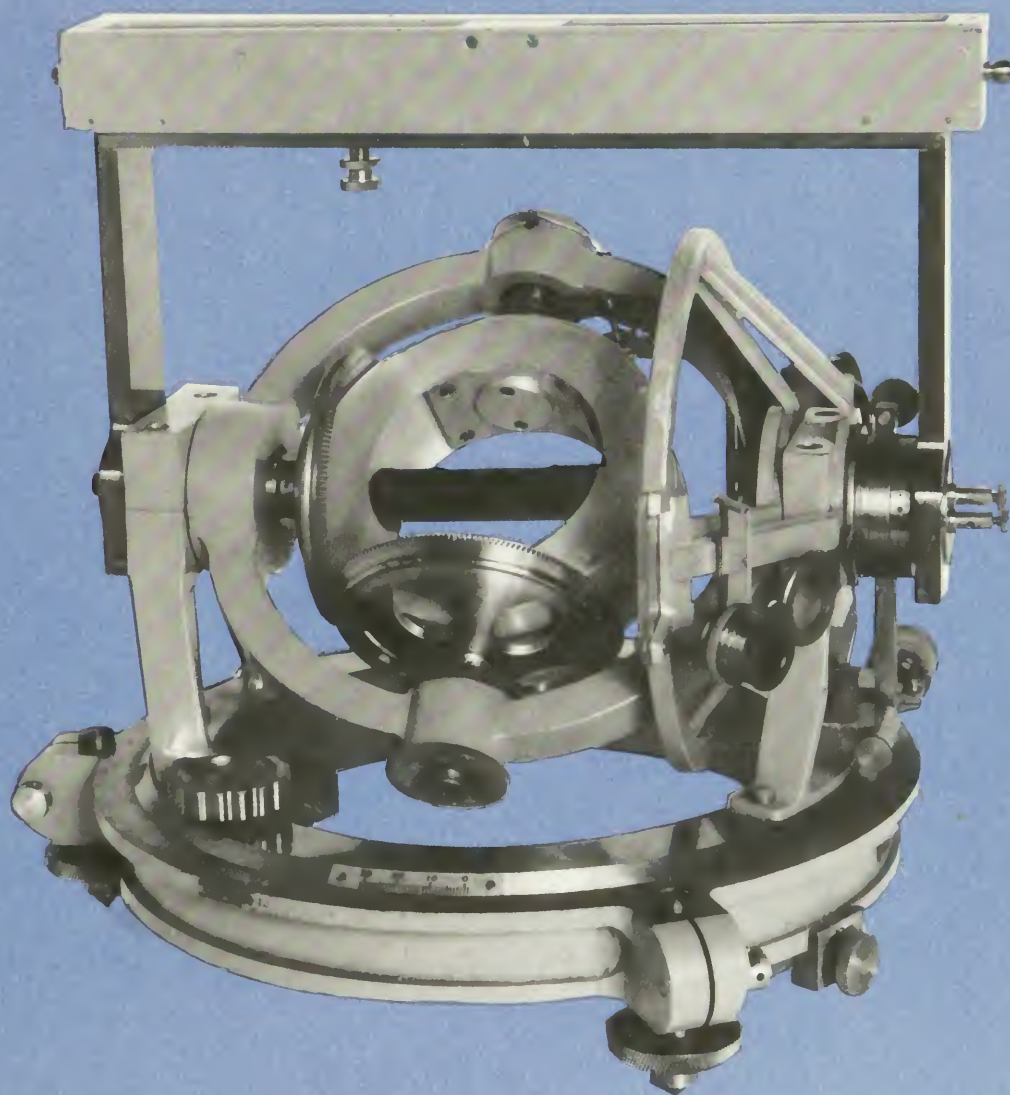

ROBERT P. MULTHAUF and GREGORY GOOD

SMITHSONIAN INSTITUTION PRESS

## SERIES PUBLICATIONS OF THE SMITHSONIAN INSTITUTION

Emphasis upon publication as a means of "diffusing knowledge" was expressed by the first Secretary of the Smithsonian. In his formal plan for the Institution, Joseph Henry outlined a program that included the following statement: "It is proposed to publish a series of reports, giving an account of the new discoveries in science, and of the changes made from year to year in all branches of knowledge." This theme of basic research has been adhered to through the years by thousands of titles issued in series publications under the Smithsonian imprint, commencing with *Smithsonian Contributions to Knowledge* in 1848 and continuing with the following active series:

*Smithsonian Contributions to Anthropology*  
*Smithsonian Contributions to Astrophysics*  
*Smithsonian Contributions to Botany*  
*Smithsonian Contributions to the Earth Sciences*  
*Smithsonian Contributions to the Marine Sciences*  
*Smithsonian Contributions to Paleobiology*  
*Smithsonian Contributions to Zoology*  
*Smithsonian Folklife Studies*  
*Smithsonian Studies in Air and Space*  
*Smithsonian Studies in History and Technology*

In these series, the Institution publishes small papers and full-scale monographs that report the research and collections of its various museums and bureaux or of professional colleagues in the world of science and scholarship. The publications are distributed by mailing lists to libraries, universities, and similar institutions throughout the world.

Papers or monographs submitted for series publication are received by the Smithsonian Institution Press, subject to its own review for format and style, only through departments of the various Smithsonian museums or bureaux, where the manuscripts are given substantive review. Press requirements for manuscript and art preparation are outlined on the inside back cover.

Robert McC. Adams  
Secretary  
Smithsonian Institution

171  
S334  
no. 48  
NMAH

A Brief History of Geomagnetism  
and  
A Catalog of the Collections of the  
National Museum of American History

*Robert P. Multhauf  
and Gregory Good*

ISSUED

APR 2

SMITHSONIAN PUBLICATIONS



SMITHSONIAN INSTITUTION PRESS

Washington, D.C.

1987

## ABSTRACT

Multhauf, Robert P., and Gregory Good. A Brief History of Geomagnetism and a Catalog of the Collections of the National Museum of American History. *Smithsonian Studies in History and Technology*, number 48, 87 pages, 76 figures, 1987.—Geomagnetism (also known as terrestrial magnetism) is the scientific study of the earth from the point of view of its magnetic properties. The alignment of a natural or artificial magnet in a north-south direction is only the best known of these. The discovery of other properties, such as the separation of the magnetic poles from the geographic poles of the earth and the “dip” of the needle in arctic (and antarctic) latitudes, interested the scientifically inclined as early as Columbus.

Mariners, who had reason to be most interested in the compass, were prominent in the study into the 18th century. But as more and more magnetic peculiarities were discovered—the apparent movement of the poles, the changes in direction, dip, and magnetic strength from year to year and even from day to day, and magnetic irregularities apparently connected with other atmospheric phenomena—the aurora borealis—the subject was taken over by the scientists. While Alexander von Humboldt, famous as a scientific traveler in the early 19th century, promoted world-wide measurement of geomagnetic phenomena, less adventurous scientists occupied themselves with the development of more sensitive instruments and more sophisticated methods. Geomagnetism attracted the attention of such leading scientists of the 19th century as John Herschel and C.F. Gauss.

One consequence was that this speciality became prominent in the establishment of international cooperation in science. In nations, such as the United States and Russia, that were both geographically large and underdeveloped, the study of geomagnetism assumed unusual importance as a kind of training ground for scientists. As time passed, however, it became clear that the numerous scientific questions posed by the subject were not to be easily answered. Geomagnetism consequently tended in the later 19th century to be absorbed by meteorology, another science whose practitioners were accustomed to continuous and tedious measurement with little scientific consequence. Geomagnetic measurements also joined gravity measurements as conventional duties of the geodetic surveyor. Most interesting, in the later 19th century, was the development of instruments capable of making different measurements simultaneously under difficult conditions, and often automatically.

In the first half of the 20th century geomagnetism became one of the topics handsomely supported by the new Carnegie Institution of Washington (which was seeking “neglected” sectors of science that were also of international interest). Then, as it was found that magnetic “anomalies” were exhibited by petroleum bearing land, the subject attracted unprecedented material support. After a generation it began at last to seem significant to science at large, in its role in the spectacular development of “plate tectonics.” Our collection and this history end at this point.

---

OFFICIAL PUBLICATION DATE is handstamped in a limited number of initial copies and is recorded in the Institution's annual report, *Smithsonian Year*. COVER: Earth inductor built by the U.S. Naval Observatory instrument shop and installed at the magnetic observatory in Sitka, Alaska in 1951. (See Figure 71.)

---

Library of Congress Cataloging in Publication Data

Multhauf, Robert P.

A brief history of geomagnetism and a catalog of the collections of the National Museum of American History.

(Smithsonian studies in history and technology ; no. 48)

Bibliography: p.

I. Magnetism, Terrestrial—History—Catalogs. 2. National Museum of American History (U.S.)—Catalogs. I. Good, Gregory. II. National Museum of American History (U.S.) III. Title. IV. Series.

QC816.M85 1986 538'.7'09 86-600156



# Contents

	<i>Page</i>
Introduction . . . . .	1
Abbreviations . . . . .	1
Brief History of Geomagnetism . . . . .	2
Magnetic Discoveries to 1800 . . . . .	2
Improvement of Instruments . . . . .	5
The Era of International Cooperation . . . . .	11
North American Research . . . . .	23
A “Quiescent Period?” . . . . .	26
Early Twentieth Century Research . . . . .	36
Catalog of Geomagnetic Instruments . . . . .	39
Notes . . . . .	43
Bibliography . . . . .	44
Figures 31–75 . . . . .	47



# A Brief History of Geomagnetism and A Catalog of the Collections of the National Museum of American History

*Robert P. Multhauf  
and Gregory Good*

## Introduction

It is the purpose of this publication to acquaint the reader with the collections of the Smithsonian Institution (National Museum of American History), in this important sector of applied physics. In order to put the instruments in context, the catalog is introduced by a summary history, of necessity something of an original production since it appears that only fragments of the history of the subject have been written—for example, Mitchell’s excellent history (see the bibliography), ends with the year 1500 (!). Moreover, since our collections come for the most part from American sources, the summary history emphasizes the story of geomagnetic research in the United States. It is also biased towards instruments and observations. Hence we wish to emphasize that our summary is not intended to satisfy the need for a general history of geomagnetism.

Geomagnetism (or terrestrial magnetism, a synonymous term) dates as a field of scientific interest from the 16th century. Although conventional magnetic compasses from that time are not rare, instruments having relevance to scientific investigation are rare, if, indeed, any at all still exist. The early instruments discussed and illustrated in our “Brief History” (Figures 1–30) are largely taken from contemporary books in the Smithsonian’s Dibner Library. From the mid-19th century our collection, while far from

exhausting the range of devices that existed, gives a fair indication of the progress of the science. Most of the instruments illustrated in Figures 31–75 represent objects in the Smithsonian collection. Number references given with figures in text and in legends refer to catalog entries for instruments in our collection.

We take this occasion to thank the Science Museum of London, the Geofysisk Institut of Bergen, and the National Maritime Museum of Greenwich, for allowing us to improve our history by illustrating certain important instruments in their collections, herein appearing in Figures 9, 15, and 18, respectively. Figures 42, 49, 50, 54, 56, 62, 66, and 73 are shown through the courtesy of the Carnegie Institution of Washington.

## ABBREVIATIONS

AdS	<i>Konigliche Schwedischen Academie der Wissenschaften</i> (Hamburg, 1739–1783). This is a German translation of the <i>Handlingar</i> of the Swedish Academy of Sciences (Stockholm).
AJS	<i>American Journal of Science</i>
APS	American Philosophical Society
BAAS	British Association for the Advancement of Science
CIW	Carnegie Institution of Washington
CS	Coast Survey (United States)
DTM	Department of Terrestrial Magnetism, the Carnegie Institution of Washington
NMAH	National Museum of American History, Smithsonian Institution
PT	<i>Philosophical Transactions of the Royal Society of London</i>
TM	<i>Terrestrial Magnetism and Atmospheric Electricity</i>

---

*Robert P. Multhauf, senior historian, National Museum of American History, Smithsonian Institution, Washington, D.C. 20560. Gregory Good, assistant professor, Program for the History of Science and Technology, West Virginia University, Morgantown, W. V. 26506.*



## A Brief History of Geomagnetism

In pre-Christian antiquity Greek practitioners of “geodesia” (geodesy, land measurement) used astronomical observation to determine the location on the sphere of the earth of Alexandria and a few other cities. The method probably began in observations of the sun and moon but ultimately resulted in a “map” of the positions of the “fixed” stars, and this in turn facilitated the improvement of the terrestrial, geodetic map. Because both were taken to be spheres, the terrestrial and the celestial, differences in the *apparent* position of the same heavenly body, as seen from two different places on earth, indicated the *real* difference in the terrestrial locations of those two places.

None of this contributed much, if anything, to the most urgent practical need for such information, for the location of ships at sea. Ancient mariners hugged the coasts and rarely ventured out of sight of land. It was noticed, however, that one star appeared to remain stationary while the others rotated around it, and that the north-south position (latitude) of a ship could be discovered by observation of the height above the horizon of this “north” star. (There is no corresponding “south” star, and, in fact, the north star itself was some distance from this position in the time of the Greek geodesists.)

When it was noticed that the naturally occurring mineral called magnet, or loadstone, aligns itself, when free to turn, approximately in a north-south direction, it was realized that this gave a means of determining direction in the daytime or when the North Star is obscured by clouds. As it was also discovered that ordinary iron can be made magnetic by rubbing it with a natural magnet stone, magnetized iron or steel needles (only steel retains its magnetism for any length of time) were adapted to this purpose and the magnetic compass was born (Figure 1). It was in use by European navigators by the late 12th century.

Out of these two preoccupations, the geodetic mapping of the earth and the use of the magnetic compass in navigation, came the science of geomagnetism.

### Magnetic Discoveries to 1800<sup>1</sup>

The compass had not been long in use in Europe when it was discovered (as early as 1300) that its direction deviates a little from “true north,” as indicated by observation of the North Star. The earth appeared to have a magnetic north pole slightly distant from the geographic north pole. The angle between the two was easily measured, by taking simultaneous observations of the direction of the North Star and the direction of the compass needle. The difference was called variation (later declination; see box, “Terminology”), and was marked on compasses by 1450, to enable the user to correct his direction to “true” geographic north (Figure 2).

The fact of “variation” also suggested a means of measuring east-west position—longitude. For assuming that the magnetic pole, like the geographic pole, is a fixed point, the angle between the two would depend on one’s east-west position. As one traveled around the world these two points would at two places be on the same straight line and the directions of the geographical and magnetic poles would coincide. Between these two places the angle between the poles would widen to a maximum and then decrease (see Figure 3). It was thought that if these angles were tabulated they could be used to determine east-west position.

The idea that longitude could be determined by variation was one of many schemes put forward to determine longitude, and was pursued with a vigor indicative of the urgency to the navigator of the “longitude problem.” Variation instruments (see Figure 4) combining a compass with a device for determining true north by astronomical means (i.e., by observing equal altitudes of the sun immediately before and after noon) were constructed in the early 16th century and in 1585 the Spanish dispatched a Pacific expedition to test such an instrument, which they called a “declinatorium.”

Increased observation, however, led to increased confusion, for mariners seemed unable to verify the observations of their predecessors. The lines of “no variation,” that is, where the geographical and magnetic poles are in the same straight line, were increased to four by Acosta in 1589, the implication being that there are two magnetic axes and hence four magnetic poles. By 1674 Robert Hooke was theorizing that the magnetic pole is in motion, rotating around the geographic pole. But Edmund Halley, who made three expeditions in 1698, 1699, and 1702 (the first sponsored by the British government for a scientific purpose) supported the idea of four poles. In 1700 he published 55 observations made between 1580 and 1682, ranging from London to New Zealand, and a map on which lines were drawn through points of equal variation (Figure 5). They correspond to the longitude lines on geographic maps, but the lines of equal variation (isogonic lines) showed no corresponding regularity. Some encouragement was found in the similarity between Halley’s chart and the results of a theory of magnetism published by Leonard Euler in the 1750s. Also in 1744, 1746, and 1757, additional “variation charts” were published in the hope of finding some regularity in the annual changes in isogonic lines. But there was no profit to navigation and the matter fell into abeyance.

It had also been noticed that the north end of the magnetic needle tilted downward in the northern hemisphere and that the south end dipped downward in the southern hemisphere. This could be measured by placing the compass in a vertical, rather than a horizontal plane (which of course required a different kind of needle support (see Figures 6



FIGURE 1.—Navigational compass, 15th century, Portuguese, a typical instrument in which a magnetized needle is fixed to the underside of a circular card on which the directions are laid out. (Copy, in the Smithsonian Institution, of an original in the Museum of the History of Science, Cambridge University.)

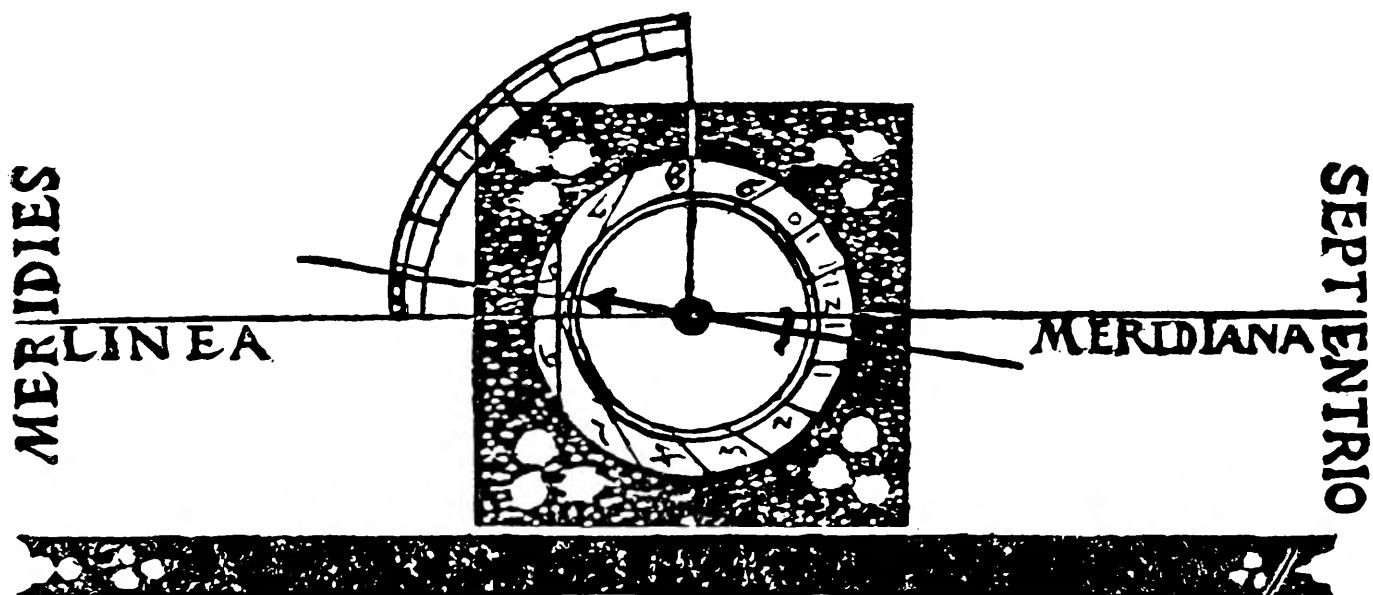

FIGURE 2.—Drawing of a compass showing the line of declination. (From Peter Apianus, *Cosmographicus Liber*, Landshut, 1524.)

### Terminology

As in any science, the terms used in geomagnetism have changed over time. Typically, the number of technical terms tends to increase until a movement towards simplification of the science combines and reduces them, after which further development again results in a proliferation of technical terms. Historical writers cannot ignore this, but can at least offer some guidance into the terminological jungle.

The angle between the direction of the magnetic compass needle, its *meridian*, and "true" (i.e., geographic) north was initially called *variation*, but later came to be called *declination*. A compass specially designed to measure this angle was called a *variation compass* or *declinometer*. When it was combined with an instrument for the astronomical measurement of geographic north it was called an *azimuth compass* or *variation transit*. It was also often called a *theodolite magnetometer*, unfortunately for logic, since the term magnetometer originally had another meaning (see below).

The tendency of the compass needle to point downward from the plane of the horizon is called *dip* or *inclination*, and the instrument for measuring this *dip needle*, *dip circle*, or *inclinometer*. It was most frequently called dip circle.

The strength or force of the earth's magnetism is called *intensity*. The simplest way to measure this is by inducing a compass needle to vibrate, by moving it out of its normal position, releasing it, and counting the numbers of vibrations or "swings" over a given time, as it returns to its normal position. This can be done either

with the declinometer or dip circle. Hansteen's instrument of about 1820, a declinometer with a needle suspended by a thread, was specially designed to measure intensity, and was called a *magnetometer*, a *unifilar magnetometer* after Gauss and Weber had introduced a decade later the *bifilar magnetometer*, in which the magnet is suspended by two (or more) threads so located as to constrain the movement of the needle. The bifilar magnetometer was also used to measure intensity, but by a different, static method. When arranged so as to record its data automatically, as by photography, the instrument was called a *magnetograph*.

As geomagnetic investigation developed, the measurement of variations in declination, inclination, and intensity over time came to be the core of the science. An instrument specially designed to measure these changes came to be called a *variometer*. But during the nineteenth century such instruments tended to acquire peculiar and specific names. Lloyd's adaptation of the dip circle to measure intensity by a static method was a *vertical force magnetometer*. Lamont's adaptation of the declinometer to the same purpose was an *horizontal intensity declinometer*, and another of his instruments, in which the needle's declination was counteracted by a nearby stationary magnet, was a *constant deflection apparatus*. Composite instruments, performing more than one function, further complicated the terminology, as in 1842 when Lloyd gave the name *induction-inclinometer* to an instrument that measured both dip and intensity.

and 7). In 1576 Robert Norman, A London instrument-maker with a wide acquaintance among ships' captains, urged the systematic observation of this magnetic phenomenon, which was called "dip." He collected observations that led him to conclude that the needle aligned itself parallel to the horizon at the Equator and dipped increasingly as it approached the poles. But here also, as observations multiplied so did exceptions. The result, as one put it, was what one would expect with "an extremely irregular loadstone." This theory fell into the same difficulties as did theories of variation. The result was another chart, showing lines of equal inclination (dip), "isoclinic" lines representing magnetic "latitude" as the isogonic lines represented magnetic "longitude." The first isoclinic chart was attempted by J.K. Wilcke in 1768.

Continued observation made matters even worse. The variation and dip, in places such as London and Paris where observations had been made over extended periods, were

found to change over time. Although possibly known earlier, it was noted in 1682 that variation varied (an awkward phraseology that led many to replace the term "variation" by "declination") from day to day; and in 1722 this was confirmed in careful observations made by the London clockmaker George Graham, with a specially made compass having a needle of 12.2 in/30.1 cm in length, protected by a rectangular brass box. By 1790 it was clear that both declination and dip varied with the season and the time of day. Agreement was still lacking on the location of the magnetic poles. Those who accepted a single north pole gave it, in English, French, Russian, and Swedish sources, a latitude varying between 59 and 75 degrees. But there was no shortage of observations, Captain James Cook made magnetic observations on his epochal voyages, 1768–1779. The French explorer E.P. de Rossel made observations in 1791–1794. Towards the end of the century the celebrated French naturalist Count Buffon published a volume on



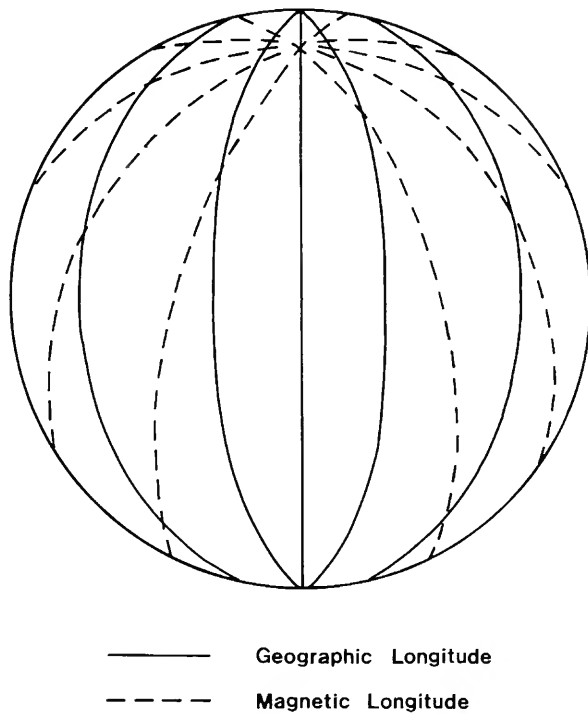

### Finding Longitude By Magnetic Declination

FIGURE 3.—This sketch illustrates how the angle between the geographic and magnetic poles changes with the position of the viewer. (Drawn by Mark Kemp.)

magnetism containing 234 pages and listing over 7,000 observations made between 1767 and 1780.

### Improvement of Instruments<sup>2</sup>

However distressing the inconclusiveness of all this was to the navigator, it made the subject even more interesting to the scientist. To test the possibility that geomagnetism varies with altitude, Benedict de Saussure made observations in the high Alps, for which he constructed a unique instrument designed to measure the effect of magnetism on an iron ball fixed to a pendulum. In 1794 magnetic measurements were made in the Saxon mines at Freiberg. The possibility that the difficulty lay, at least in part, in the imperfection of the instruments used was naturally explored. Although, as has been noted, special instruments for variation (declination) and dip (inclination) had existed since the sixteenth century, most of the observations that revealed the complexity of terrestrial magnetism were made with an ordinary ship's compass. But in the last half of the eighteenth century the improvement of the compass was taken up by the scientist, who increasingly exhibited at that time a virtual fanaticism for precision measurement.

In France, Duhamel (probably H.L. Duhamel du Monceau) published in 1750 an account of improved magnets and in 1772 a description of his magnetic observatory for which a Paris optician named Antheaume constructed six declination compasses, with needles from 6 to 15 inches in length, and of varying weights, mounted on stone pedestals placed in groves (bosquets) in the park of Denainvilliers. A scale six feet long, made of close-grained limestone, was located 52 feet from the compasses, at the same level so that their directions could be observed by looking along sights mounted on the needles. Every precaution was taken. The compasses were enclosed to protect them against the atmosphere, with portholes of horn to avoid any electrical effect of glass, and their supporting pedestals were made without mortar to eliminate the possibility of included iron (see Figure 8). Duhamel does not tell what use he made of what must have appeared to his neighbors to have been a sculpture garden.

British instruments, like British institutions at that time, were simpler, and the variation/declination compass "in the Royal Society's House" in London, as described by Henry Cavendish in 1776 (see Figure 9), was simpler. It too was placed in a garden to protect it from the influence of iron used in buildings (although Cavendish found later that it functioned just as well in a room). This instrument, which had a needle made by the well known London instrument-maker Jonathan Sisson, was used for twenty years, its results being published in 1806. It is clear that by this time geomagnetic instruments had become staples of the instrument-maker's trade. The Royal Society's dip needle was made by Edward Nairne, an instrument-maker who was a Fellow of the Society, and who made a variation compass and dip needle for Harvard College in 1765. Still at Harvard, these may be the first such instruments brought to North America. George Adams advertised similar instruments in 1785, and the third edition of Tiberius Cavallo's *Treatise on Magnetism* (1800) was prefaced with an advertisement for a complete set of instruments by W. & S. Jones.

The needle was the crucial component, and needles were moved from one instrument to another and the same needles were tested in London, Paris, and elsewhere. Cavallo, although convinced that some mathematical regularity governed terrestrial magnetism, was pessimistic of the possibility of discovering it, because of "the irregularity of the motion of the magnetic poles."

Much ingenuity was expended on the reduction of friction on the pivot point of the needle. Cavallo wrote of "a new suspension" in which the needle was suspended by a horse hair. Thus he would appear to have been unaware that this kind of suspension had been virtually "perfected" in France over two decades earlier. Charles Coulomb, a French military engineer, undertook the improvement of the compass in 1776, in pursuit of a prize offered by the

FIGURE 4.—Instruments for measuring declination (variation). Left, above: magnetic compass attached to an armillary sphere. (From Mark Ridley, *Short Treatise of Magnetical Bodies and Motions*, London, 1613.) Left, below: magnetic compass with quadrant attachment. (From Petrus van Musschenbroek, *Physicae Experimentalis*, Leiden, 1729.) Right: "variation transit," by Peter Dollond, about 1800. (From *Encyclopaedia Britannica*, 8th edition, volume 14 (1857)).

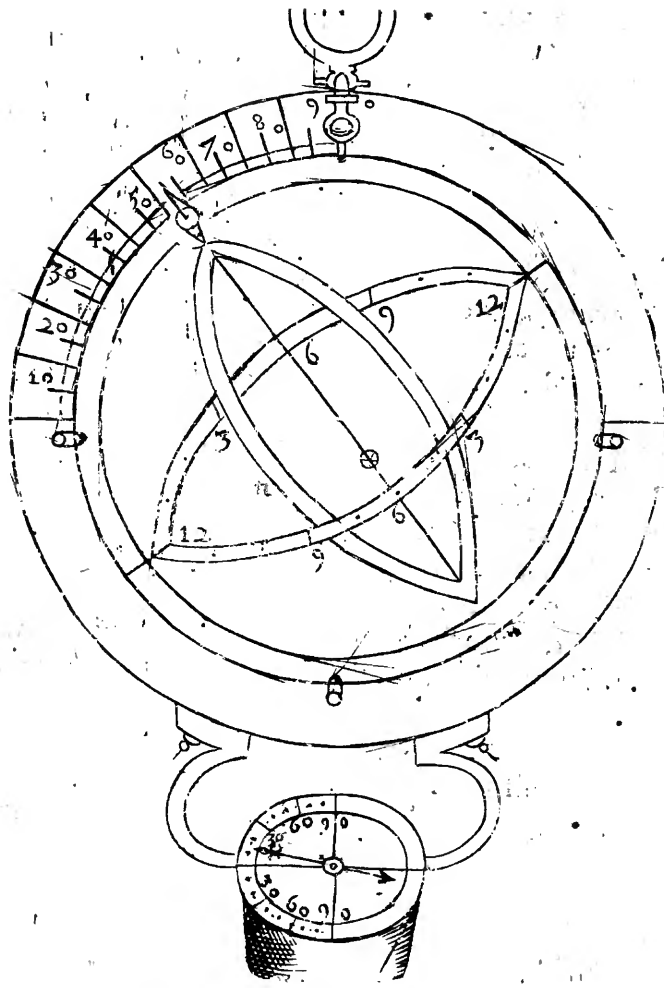

Fig. 3.

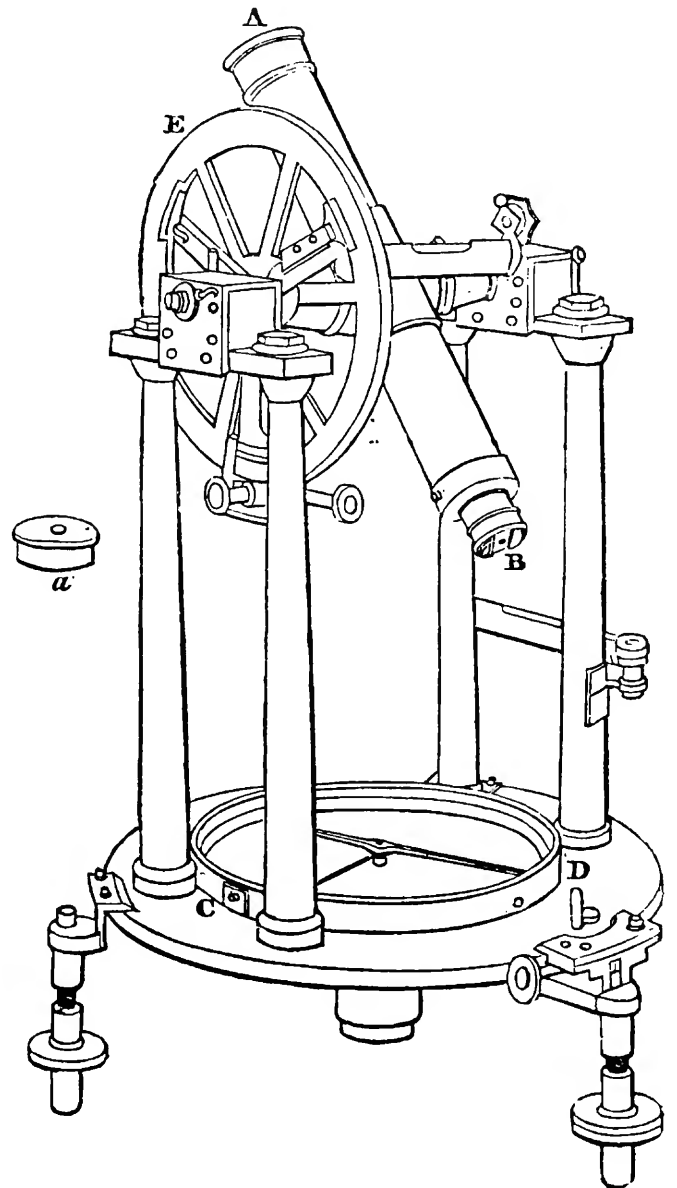
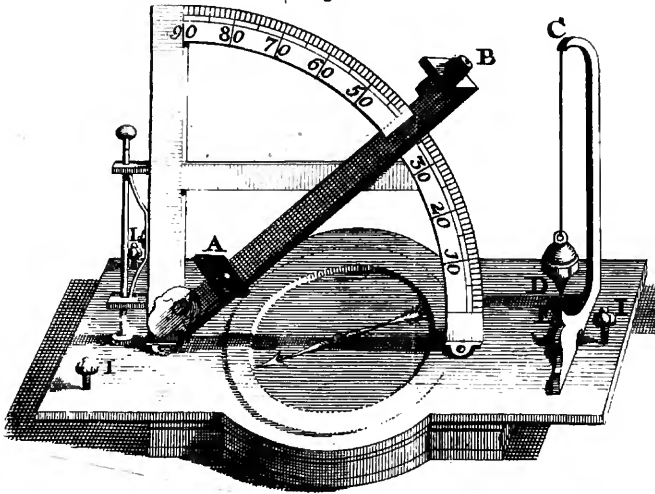



FIGURE 5.—“Chart of the lines of equal magnetic variation,” by Edmund Halley, 1701. (Reprinted from TM, 1 (1896).)



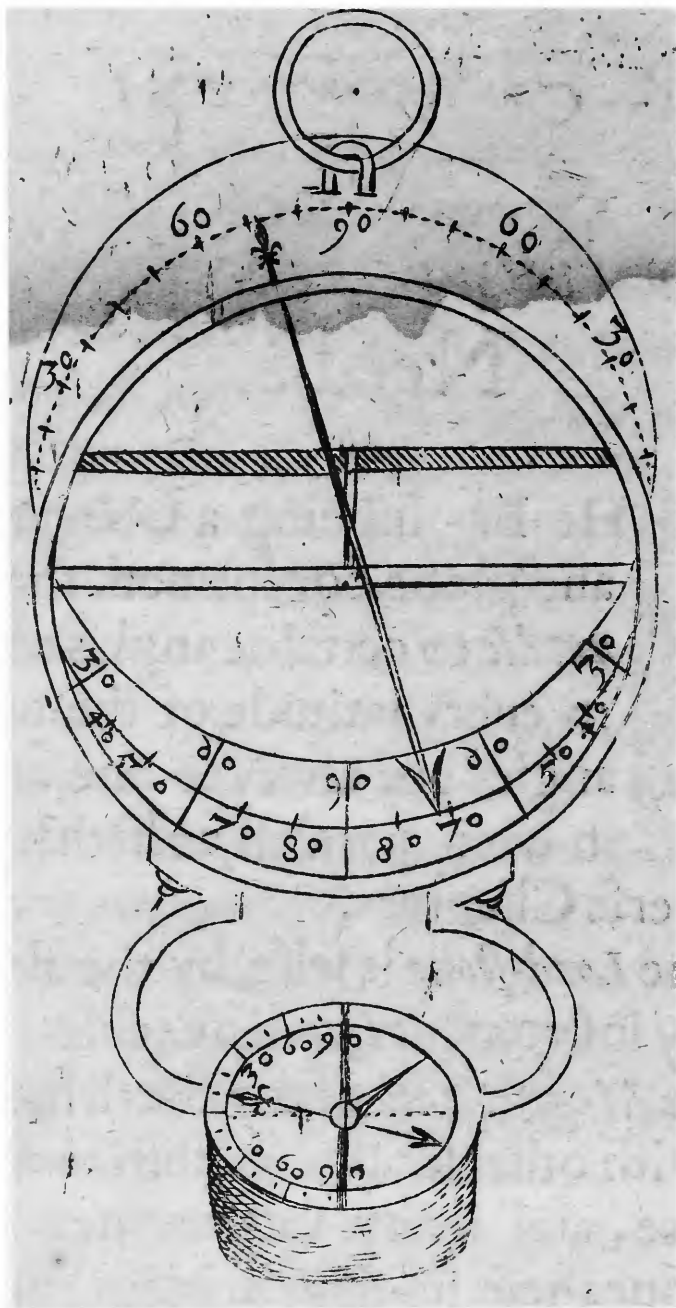

FIGURE 6.—Magnetic “dip needle,” mounted on a conventional compass. (From Mark Ridley, *Short Treatise of Magnetical Bodies and Motions*, London, 1613.)

Académie des Sciences in Paris. In the memoir that won the prize (1777) Coulomb described a compass suspended by a thread, instead of supported on a pin (Figure 10). Although he did not originate this idea, Coulomb was the first to pursue it scientifically, working out a mathematical formulation for the forces (of torsion) involved in the twisting of threads and wires, with, as a by-product, the invention of the torsion balance.

Coulomb used the balance to measure many small forces, including those of terrestrial magnetism. By 1777 his thread-suspended compasses had been adopted by the Paris observatory and improved by J.D. Cassini. Coulomb and Cassini were not instrument-makers and the instruments may have been made by Etienne Lenoir (1744–1832), one of the very few French instrument-makers of the time whose skill compared with that of the English makers mentioned above.

Even “identical” magnetized needles varied in strength, and the same needle often varied in strength from one time to another. Some wondered if the strength of terrestrial magnetism could not vary similarly, thus accounting for some of its irregularities. On this assumption, as pure science replaced navigation as the objective of studies in geomagnetism, a new measurement was added to declination and inclination, namely “intensity,” a quantitative measure of magnetic force. A method was introduced by J.C. Borda in 1778 for comparing intensities at various places by measuring the rate of vibration of the needle. That is, advantage was taken of the fact that the compass needle aligns itself magnetically, not instantaneously, but by oscillating back and forth across the line (magnetic meridian) on which it finally settles. Measurement of intensity assumed that the needle would oscillate about its meridian more quickly as the earth’s magnetic intensity was greater. However, because this rate of oscillation also depended on the magnetic strength of the needle, each instrument yielded a different value. Intensities determined by this method were usually called “relative” because they were relative to a particular needle. For this reason, a single needle was often used in different places to compare intensities. Two or more needles could also be oscillated together in one location to obtain a temporary standard of comparison.

The vibration of the needle of the dip-needle/inclinometer was considered analogous to that of the pendulum used in measuring the force of gravity, and as in the latter case, forces were compared as the square of the number of oscillations made in the same time. They were also relative. Such measurements were made on the de Rossel voyage of 1791–1794 and by Alexander von Humboldt on his expedition to South America of 1798–1804, using an instrument made by Lenoir. In the latter year J.L. Gay-Lussac and J.B. Biot made intensity measurements from a balloon over Paris, also with instruments by Lenoir.

These observations established that the intensity of terrestrial magnetism increased with latitude. However, the dip needle was soon found inadequate for this measurement, due to pivotal friction, and the suspended needle of the declination instrument came into favor. Because an oscillating horizontal needle measures the horizontal intensity only, while the dip needle measures total intensity (see box, “Measurements and Calculations”), the latter method required a simple trigonometric transformation. Humboldt

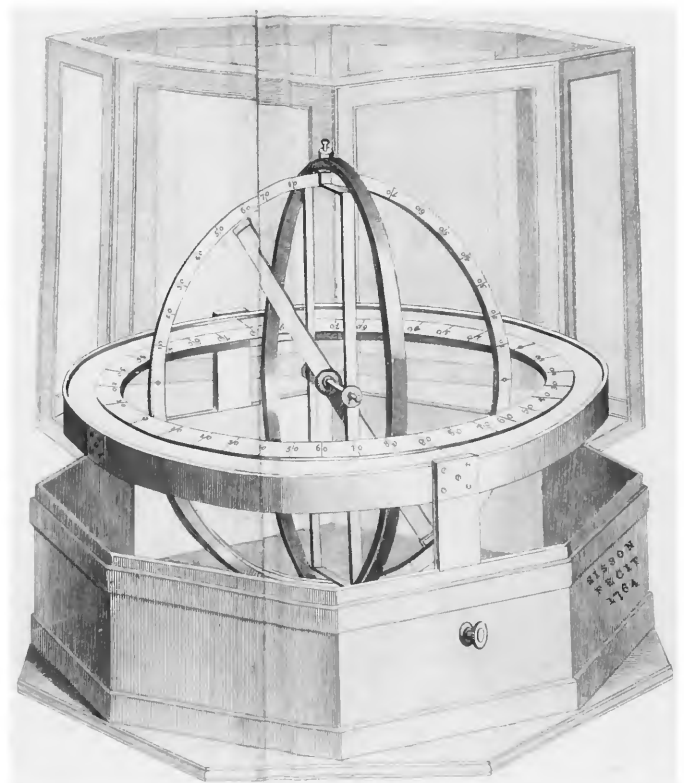
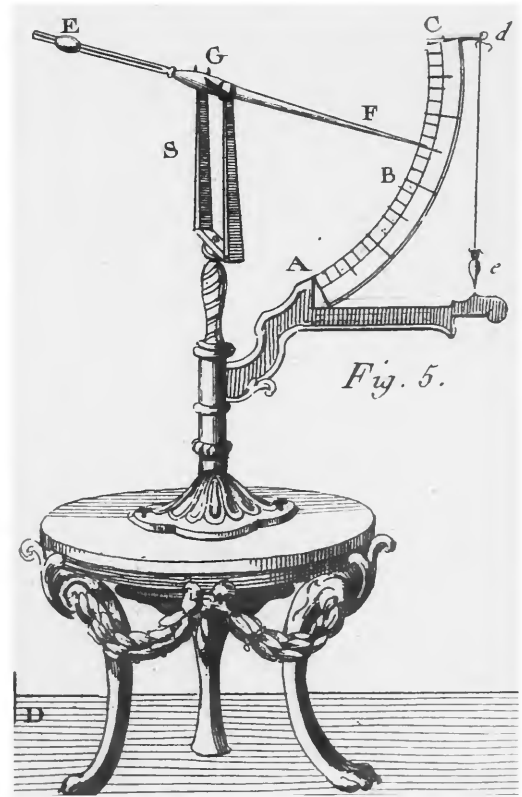
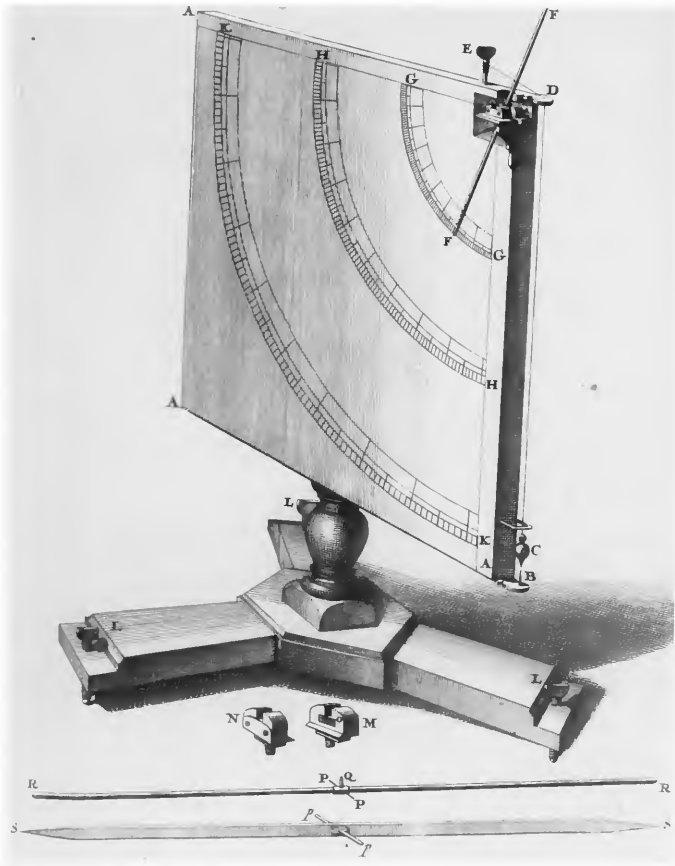

FIGURE 7.—Instruments for measuring magnetic “dip.” Left: Petrus van Musschenbroek called this apparatus an “inclinorium.” (From *Physicae Experimentalis*, Leiden, 1729.) Right, above: demonstration apparatus. (From J.A. Sigaud-Lafond, *Description et usage d'un cabinet de Physique Experimentale*, Paris, 1755.) Right, below: this elaborate apparatus, also illustrated by Musschenbroek, was made by John Sisson, of London.

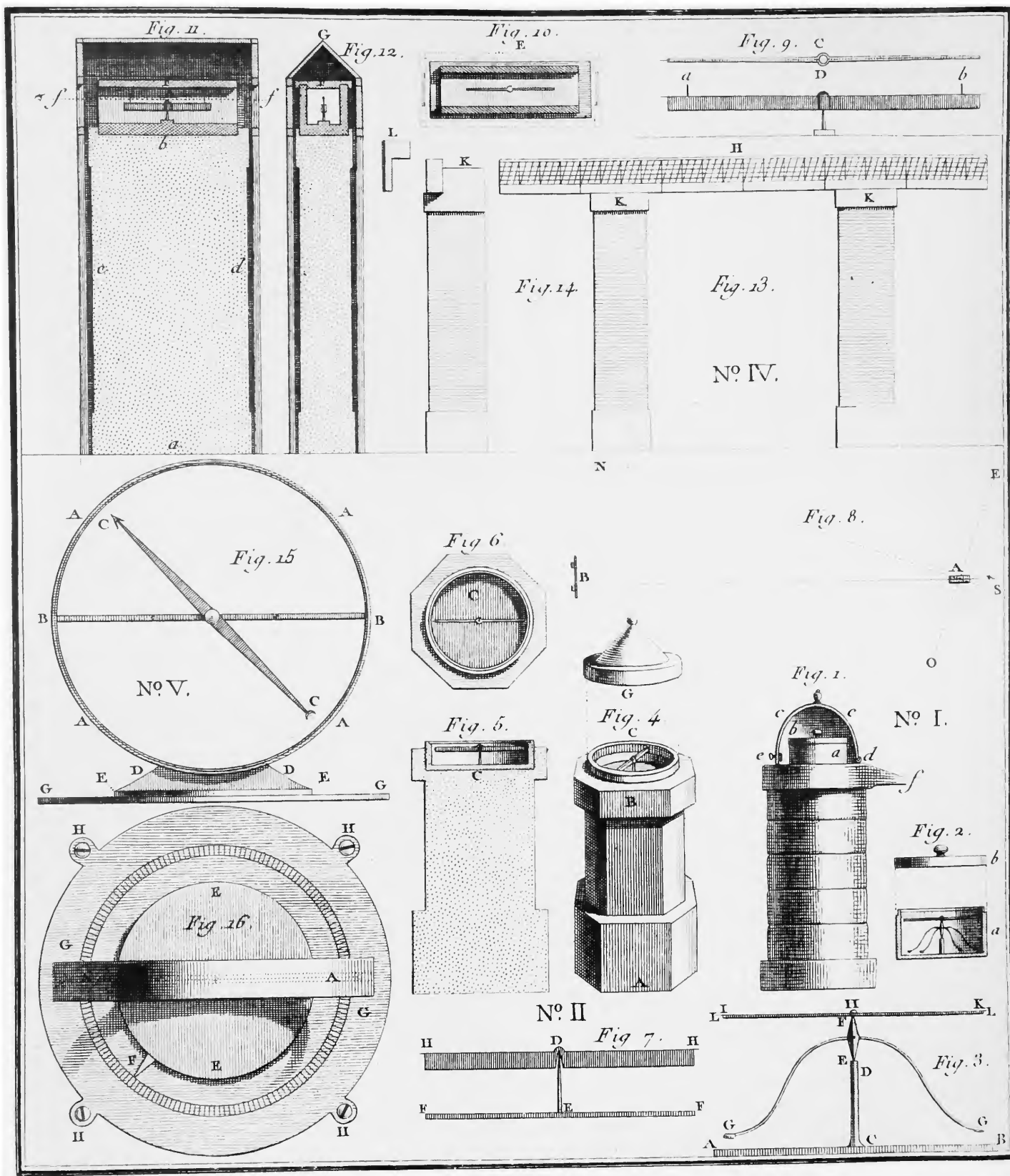

FIGURE 8.—Geomagnetic apparatus of Duhamel, which was installed in the Parc de Denainvilliers, Paris, in 1750. Figs. 1–3 and 9–12 show declination compasses. Fig. 8 shows their position relative to the scale (fig. 13), which is 52 ft/15.8 m distant. Figs. 15, 16 show the inclination (dip) needle. (From the *Mémoires de l'Académie Royale des Sciences*, Paris, for 1772.)



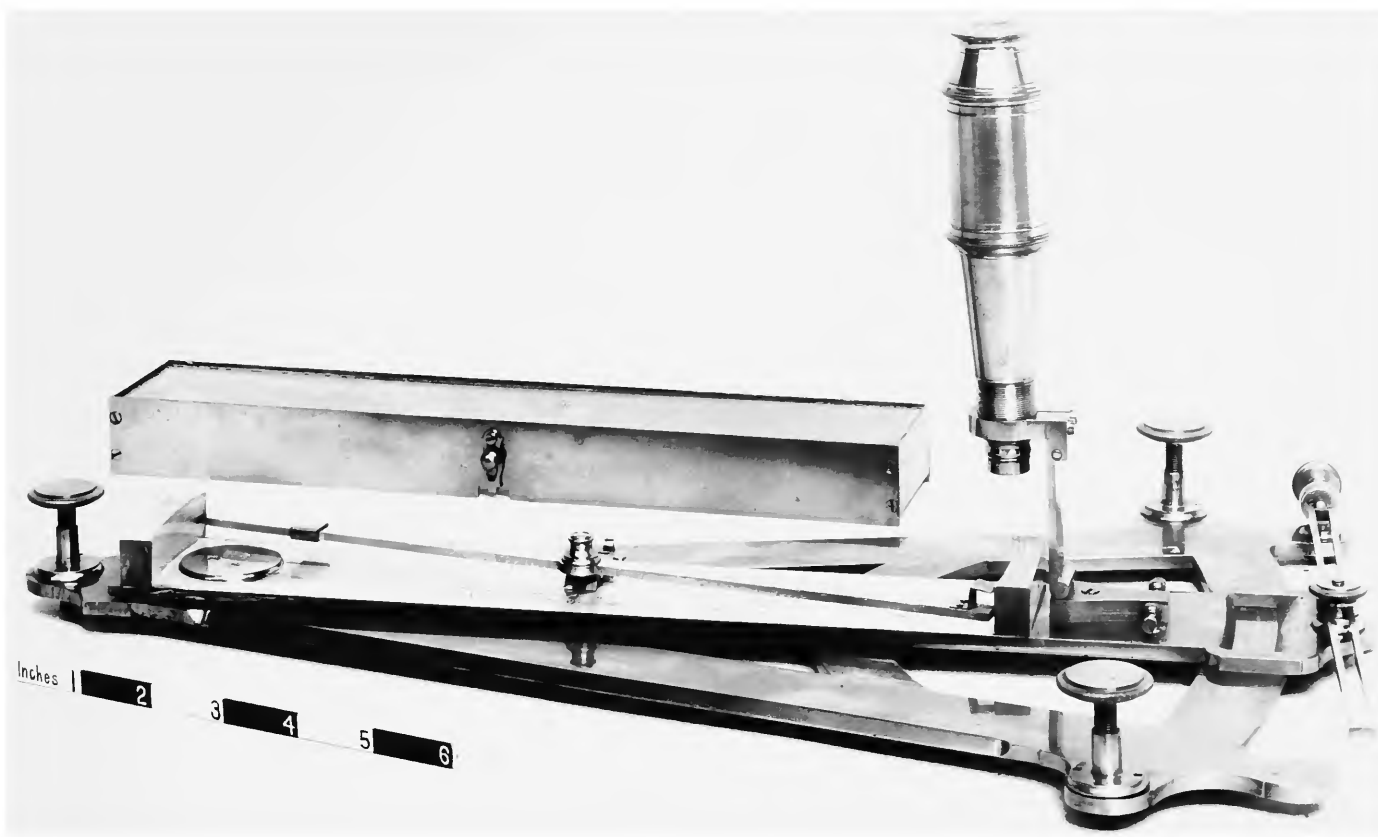

FIGURE 9.—“Variation compass” made by George Adams of London, in the Science Museum, London, with whose permission this illustration is reproduced. It appears to be virtually identical to the Royal Society instrument used by Henry Cavendish, and described by him in the *Philosophical Transactions of the Royal Society*, Volume 66 (1776).

and Gay-Lussac used this method in Italy in 1805–1806, using a needle suspended by a silk thread.

### The Era of International Cooperation<sup>3</sup>

Humboldt’s conclusion, from his South American observations, that magnetic intensity varies from place to place, established geomagnetism as a subject particularly deserving the attention of the scientist. Indeed, one scientist called it “the great physical mystery” left unanswered by Newton. This ended the era when geomagnetism was an incidental study, primarily pursued by perambulating explorers, and began another in which the subject was primarily a scientific discipline situated in “observatories,” many temporary but an increasing number permanent. Humboldt’s research symbolized this change, for after his visit to Italy he settled himself, except for a brief excursion to Siberia (in search of a magnetic pole), in Paris and Berlin, where he established geomagnetic observatories on several occasions. For over half a century Humboldt lent his great reputation to the

promotion of the scientific study of the earth, and particularly to terrestrial magnetism.

In England, George Gilpin, Secretary of the Royal Society, published in 1806 the observations made over thirty years with the antiquated instruments of the Society. In 1813 Mark Beaufoy, a wealthy patron of the Society, established an observatory at Bushey Heath (Hertfordshire) where he made frequent observations for nearly a decade, using a declinometer similar to that of the Royal Society but incorporating a theodolite for celestial observations (Figure 11). In 1818–1820 Edward Sabine used instruments made by Nairne and Blunt on three Arctic expeditions, and a Russian naval expedition of 1826–1829 used instruments obtained from England. The firm of Dollond, by this time the best known English instrument-makers (thanks to their development of the achromatic lens), now appears as makers of magnetic instruments, including a metal-free instrument (made of mahogany and ivory) with a suspended needle, designed for the measurement of daily variation (Figure 12).

Fig. 4.

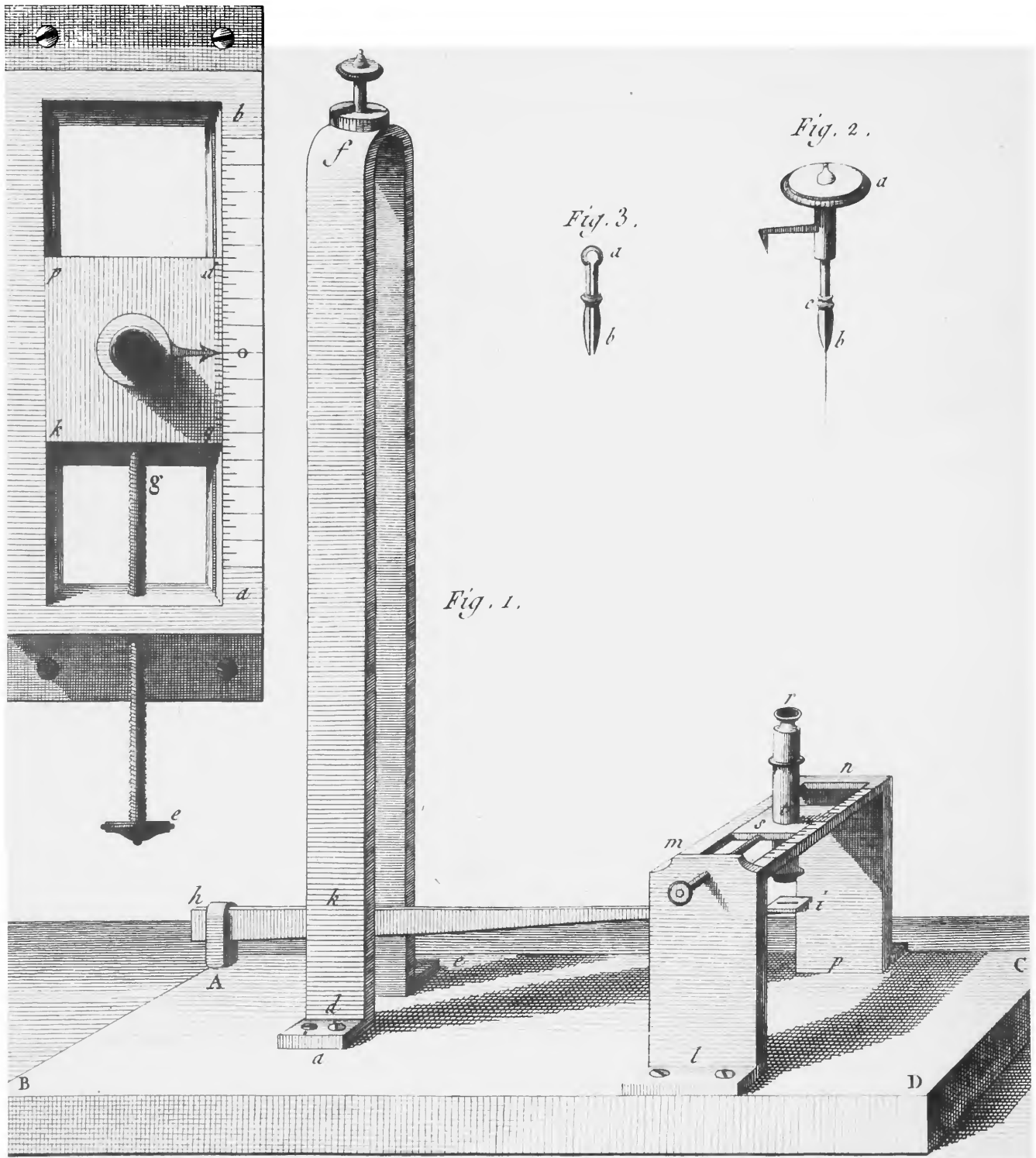
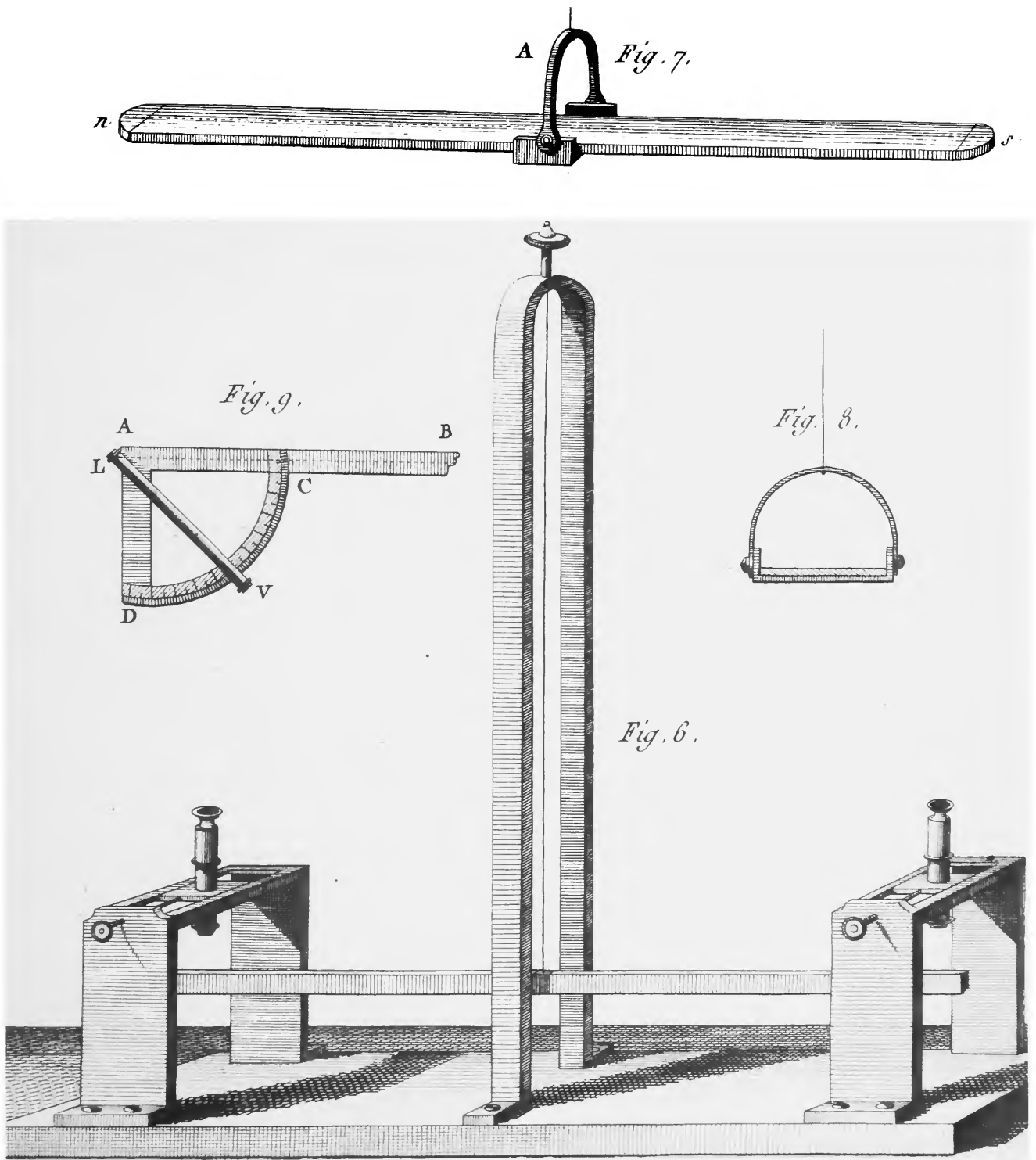

FIGURE 10.—Coulomb's thread-suspended magnets, 1785. From *Mémoires de l'Académie Royale des Sciences* (Paris), for 1785.) Above: instrument for determination of the magnetic meridian. The magnet is 18 pouce (inches)/46 cm in length. Right: instrument for the measurement of "variation" (declination).



It was the observation of daily (diurnal) variation that inspired Beaufoy's activity, and subsequently that of other observatories. At Paris, D.F.J. Arago, who, under the influence of Humboldt, had become involved in the observations

there, reportedly took 52,599 measurements between 1820 and 1835.

Under the patronage of Humboldt and Arago, the young Paris instrument-maker, H.P. Gambey (1787-1847), was to

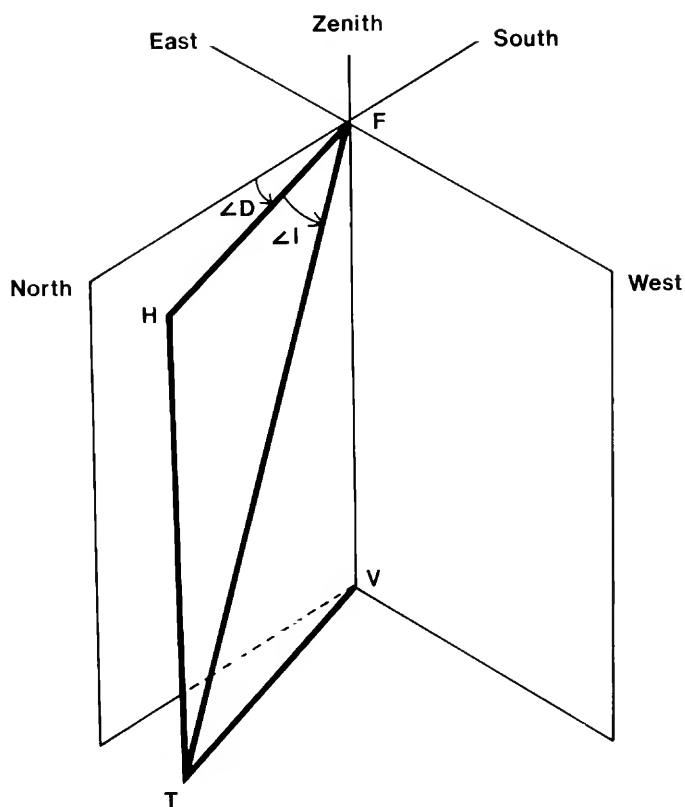

#### Measurements and Calculations

In the accompanying diagram,  $D$  and  $I$  represent the angles of declination and inclination, which can be measured directly. A magnetic needle suspended from its center of gravity would lie along line  $FT$ . The lines  $FH$ ,  $FV$ , and  $FT$  represent the horizontal, vertical, and total intensities of the force that returns a deflected needle back to this neutral position. Hence, the ratio of the vertical intensity to the horizontal intensity equals the tangent of the inclination ( $FV/FH = \tan I$ ). The total intensity  $FT$  combines these forces according to the familiar parallelogram of forces ( $FT = FH \cdot \sec I$  or  $FV \cdot \csc I$ ). Because the horizontal intensity could be measured with greater precision than either the vertical or total intensity in the mid-19th century, it was the preferred intensity measurement. (Diagram by Mark Kemp.)

become the most important French maker of geomagnetic instruments and the producer of what was long considered the "classic" magnetometer (Figures 13 and 31). Arago's account of the work in Paris reveals the spread of Gambey instruments through the western world. By 1818 Arago was using a compass of William Ritchie's design, made by Gambey, which was destined for "the University of Cambridge in America" (Harvard, which still has the instru-

ment). In 1822 Arago was again observing with a Lenoir compass, which was then to go around the world with the explorer L.I. Duperry, and with a Gambey compass destined for the Finnish University at Abo. In 1829 it was a Gambey compass destined for the University of Freyberg (Freiberg). By 1831 he had a Gambey compass owned by J.F. Encke, Director of the astronomical observatory in Berlin, as well as a Gambey instrument destined for Frederick Rudberg of Stockholm. Although instruments used in North America were usually English, the military academy at West Point, which was principally supplied with French scientific instruments, had a dip circle by Gambey. A declinometer by Gambey (Figures 14 and 32) was used by Alexander Dallas Bache in the 1840s.

With the termination of the Napoleonic wars Humboldt undertook to promote government support for observations of terrestrial magnetism. The first fruits were a series of French naval expeditions that aimed to sail along the "magnetic equator," that is, the line of no inclination, which Humboldt had discovered in Peru. In 1829, on the occasion of his brief expedition to Siberia, Humboldt addressed to the Academy of Sciences in St. Petersburg a plea for the establishment of geomagnetic observations in the Russian Empire. The proposal was accepted and acted upon with remarkable alacrity. Within three or four years he addressed a similar proposal to the British, in a letter in which he reported having received favorable responses from France, Prussia, Hannover, Denmark, and Russia, and noted that permanent stations had already been established at Paris, Berlin, and the Freiberg (Saxony) mines, Copenhagen, Iceland, St. Petersburg, Moscow, Kazan, Barnoul (at the foot of the Alta mountains), Nertschinsk (near the frontier with China), Nicolajeff (Crimea), and Peking (in "the garden of the Greek monks"). Humboldt recommended the establishment of such observatories in the far-flung British dominions, particularly in the Cornwall tin mines, at the Cape of Good Hope, and in Canada (he warned against Montreal because of its iron roofs).

Humboldt's recommendation was presumably helpful, but the British were already among the most active observers in Europe and a joint petition by the British Association for the Advancement of Science and the Royal Society were crucial in securing government support. Led by Edward Sabine (1788–1883), the British Association, from 1831, made terrestrial magnetism one of its special interests.

Sabine had found reason, in consequence of his arctic expeditions of 1818–1820, to contradict the supposition that magnetic intensity would be greatest near the poles. His claim was confirmed in 1832 by Captain J.C. Ross, who had taken a Jones dip circle, among other instruments, to the magnetic latitude 89 degrees, 41 minutes. Ross then joined Sabine and Humphrey Lloyd in making observations in Ireland, which were published, along with the observations made in England and Scotland in 1836. This effort



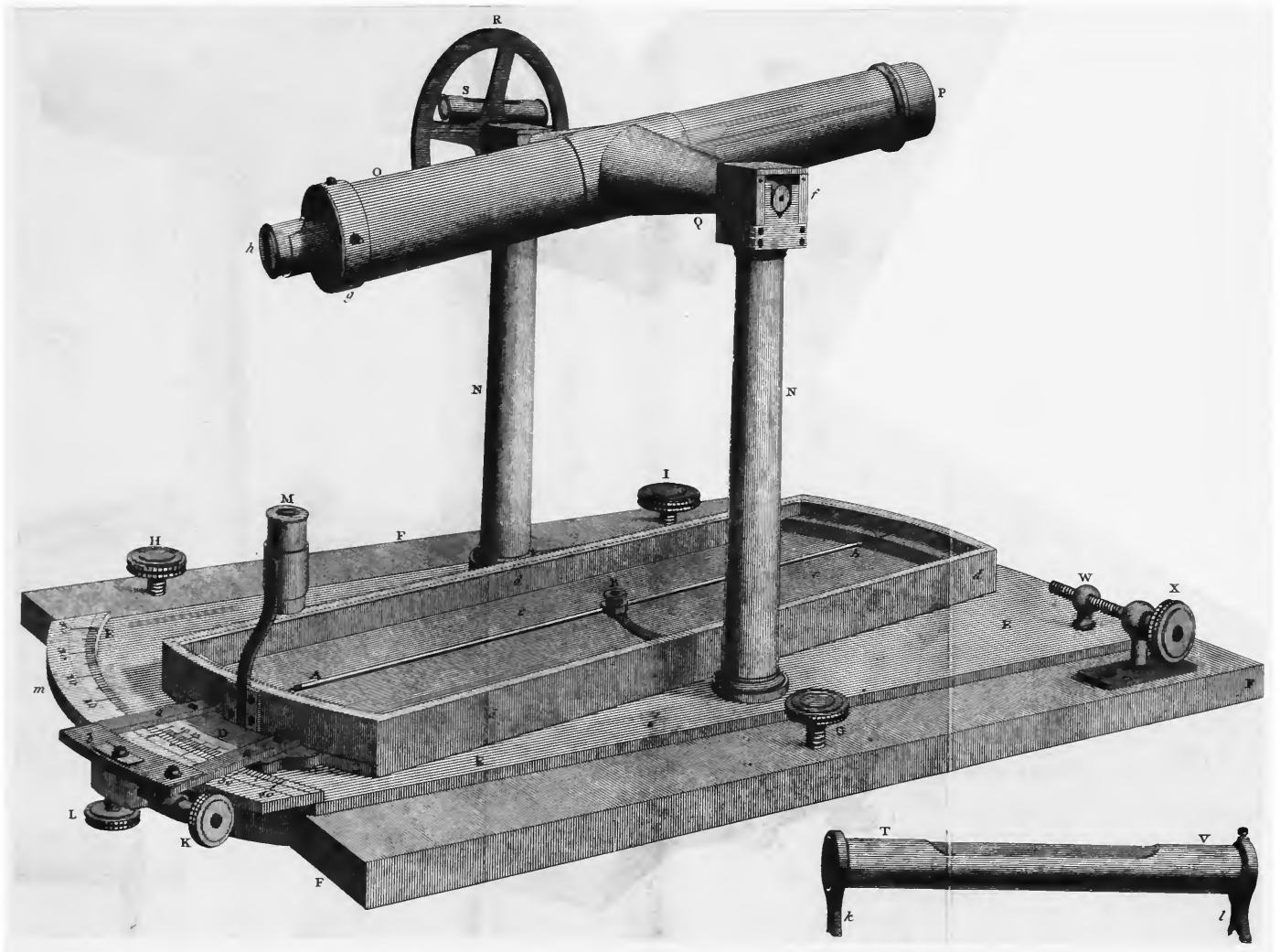

FIGURE 11.—“Variation compass” used by Beaufoy at his observatory at Bushey Heath, Hertfordshire, as described and illustrated by Beaufoy in *Annals of Philosophy*, volume 2 (1813). It differs from the Royal Society instrument (see Figure 9) principally in the incorporation of a “transit telescope.”

constituted one of the first detailed regional magnetic surveys.

The attempt to establish systematic observations was but one of several focal points of terrestrial magnetic work in the early nineteenth century. Others were the search for the poles, both north and south, the improvement of instruments and of theory. One prominent participant was Christopher Hansteen (1784–1875), a Norwegian who had become interested in magnetism under the influence of Oersted in Copenhagen and who won a prize that had been offered by the Danish Academy of Sciences in 1811 for a theory of geomagnetism. Hansteen’s theory assumed the existence of two magnetic axes, and he went off to Siberia in 1828, with a Dollond dip circle, to look for a second North Pole. Hansteen, who had been a professor at the Norwegian University at Christiania (Oslo) from 1814, also

attempted to found an observatory there and occupied himself with the improvement of the instrument for measuring magnetic intensity. He was to be most successful in the latter, and established a method that was to be standard for decades. Hansteen’s method aimed to circumvent the peculiar problem that the force of a magnet cannot be referred to a single point but involves two points, the north and south poles, and that these are themselves not precisely identifiable points. To some degree this could be offset by using long magnets, thus separating the poles. Hansteen’s declination instrument, called a “magnetometer,” consisted of a magnetized steel cylinder about 30 inches long and 0.1 inch in diameter (which he obtained from Dollond in London), protected by a wooden box and suspended by a silk thread in a vertical wooden tube 56 inches long. The needle was set in motion by bringing an iron rod in its vicinity, the

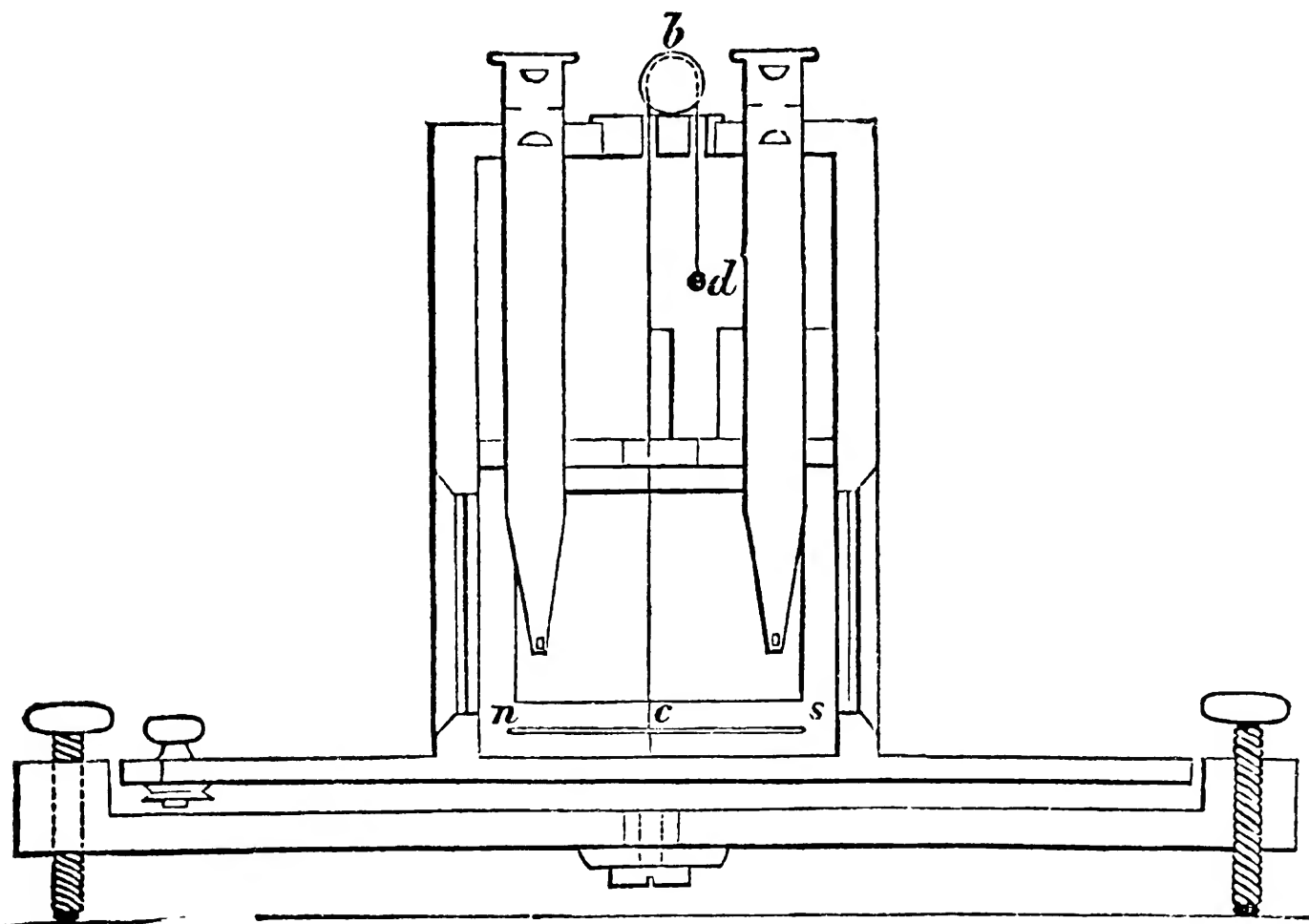

FIGURE 12.—“Diurnal variation instrument” of (George) Dollond, with thread-suspended needle, about 1825. The test-tube shaped pieces are microscopes. (From *Encyclopædia Britannica*, 8th edition, volume 14 (1857).)

time required for 300 vibrations being taken as the measure of intensity (Figure 15 shows a surviving Hansteen magnet of smaller dimensions).

In 1818 Humboldt succeeded in recruiting to the field C.F. Gauss, a Göttingen professor who, at 51, had already for a generation been the most prestigious mathematician in Europe. In the next decade Gauss brought to Göttingen the 27-year-old physicist, W.E. Weber, and the two studied geomagnetism for almost ten years, until 1837 when Weber was discharged from the university for resisting political pressure on the faculty. In 1833 Gauss, the theoretician, published his *Intensitas vis magneticae terrestrius ad mensuram absolutam revocata* (The Intensity of Magnetic Force Reduced to Absolute Measure), an epochal work in that it represented the first attempt to measure a non-mechanical quantity (i.e., magnetism) in terms of what were in the canon of Newtonian science “absolute” units, namely mass,

distance, and time. The experiments that went with this theory, Weber’s particular contribution, were conducted in a new magnetic observatory constructed at Göttingen.

The observatory occupied an oblong room 36 feet long, in the direction of the magnetic meridian. In the main instrument the “needle” was a bar 23.62 inches long and weighing 3.75 pounds. It was ultimately increased to 25 pounds and the supporting “thread” correspondingly strengthened, being either a bundle of threads or a wire, about six feet long. To measure intensity the measurement of vibrations was followed by a second step in which the magnetic moment of the bar was taken into account (see box, “Gauss, Weber, and Absolute Values,” and Figure 16). The result was a value of the earth’s magnetic intensity that could be replicated by all instruments and magnetic needles.

In its simplest form the Gauss magnetometer was “read” by putting a mirror on the end of the magnet, a method

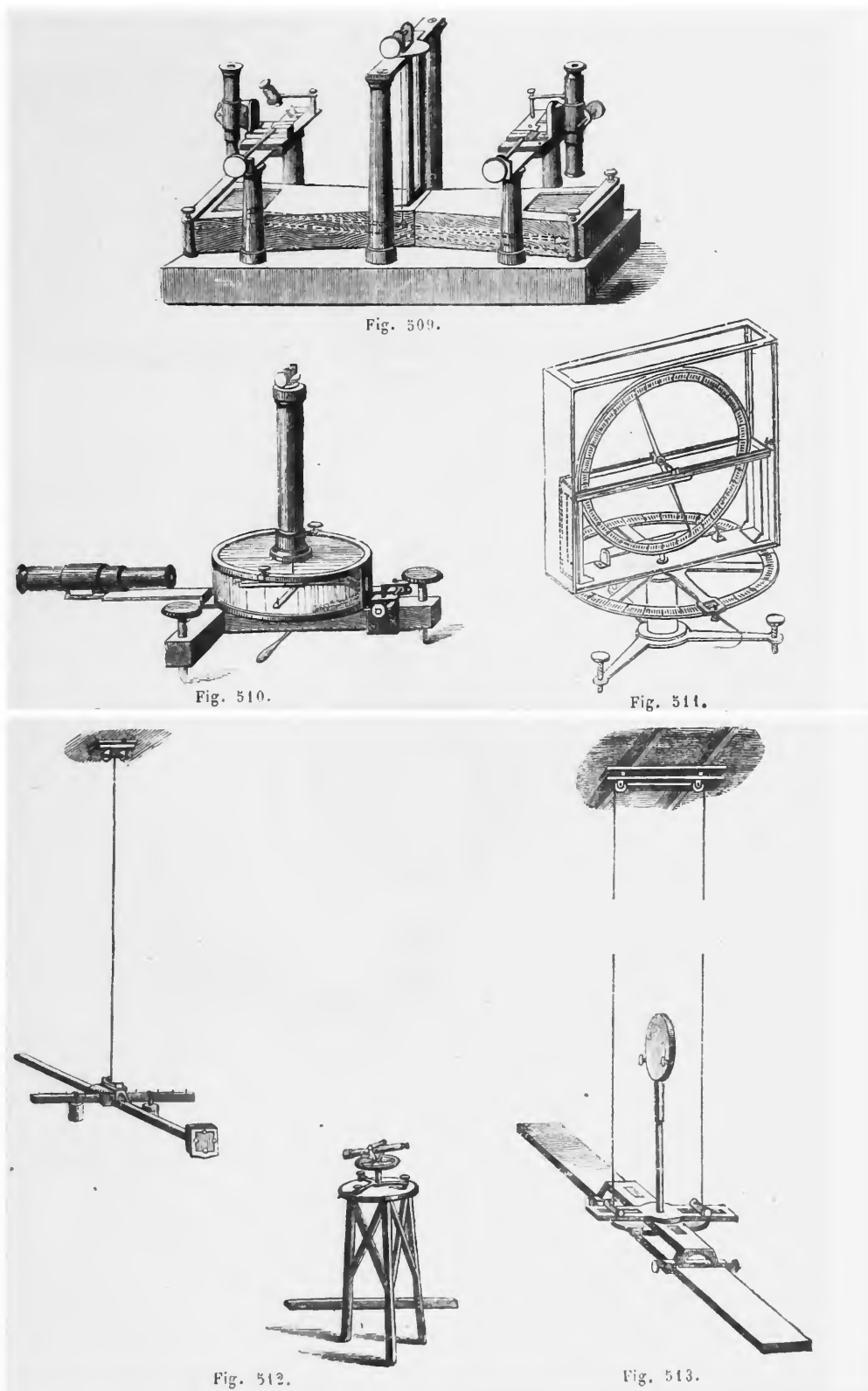

FIGURE 13.—Some instruments commercially available in the mid-19th century. (From *Catalogue des Instruments* of the Paris maker, Deleuil (1863).) 509, compass for diurnal variation (similar to No. 1, Figure 31, in the present collection). 510, unifilar magnetometer for intensity measurement (similar to No. 5 in the present collection). 511, inclination compass with vertical circle (i.e., a dip circle, similar to the Froment and Barrow instruments, Nos. 29 and 30, Figure 60 in the present collection). 512, Gauss unifilar magnetometer, with observing telescope. 513, Gauss bifilar magnetometer.

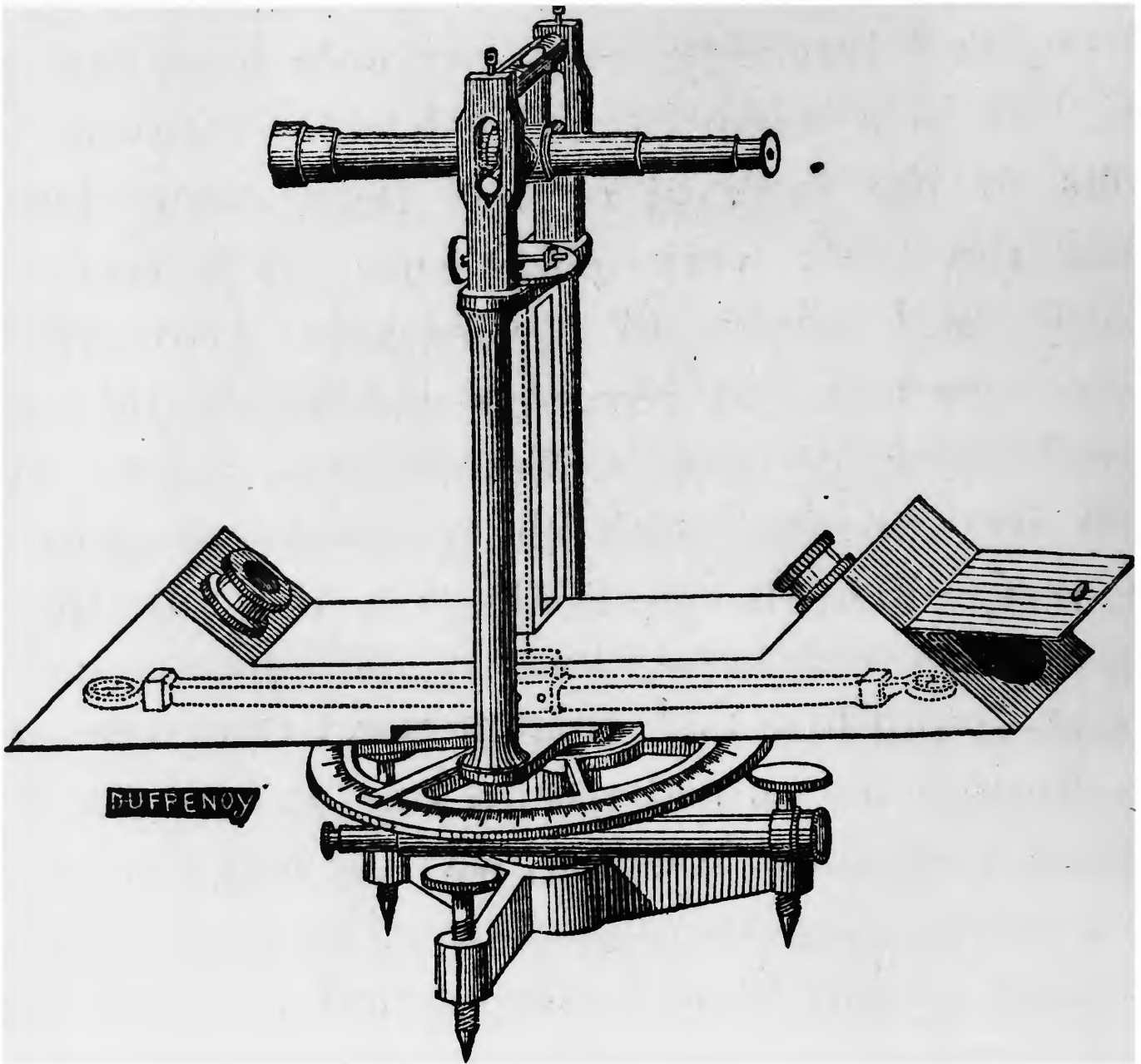

FIGURE 14.—Declination compass by Gambay. No. 2 in this collection (Figure 32 in this study) exemplifies this type of instrument. (From A. De la Rive, *A Treatise on Electricity*, London, 1858.)

introduced in 1826 by Johann Poggendorff. The scale, located beneath the observing telescope, was viewed through its reflection from the mirror. Such an arrangement was vulnerable to the influence of air currents on the magnet and to the time taken for the magnet to settle on its meridian, and the instrument was soon modified to counter these difficulties. The magnet was placed within a protective box and the mirror was placed on the supporting "thread" outside the box. The poles of the magnet were

encased in copper, which had a damping effect on its movement. In a modified version intended to indicate changes in horizontal intensity, the magnet was supported by two threads so located as to hold it approximately at right angles to the magnetic meridian. This arrangement was called the "bifilar" magnetometer (see Figure 13).

Weber had the ingenious idea of putting to use the then new discovery of electromagnetic induction. A circuit of wire, located near one end of the magnetometer, was car-

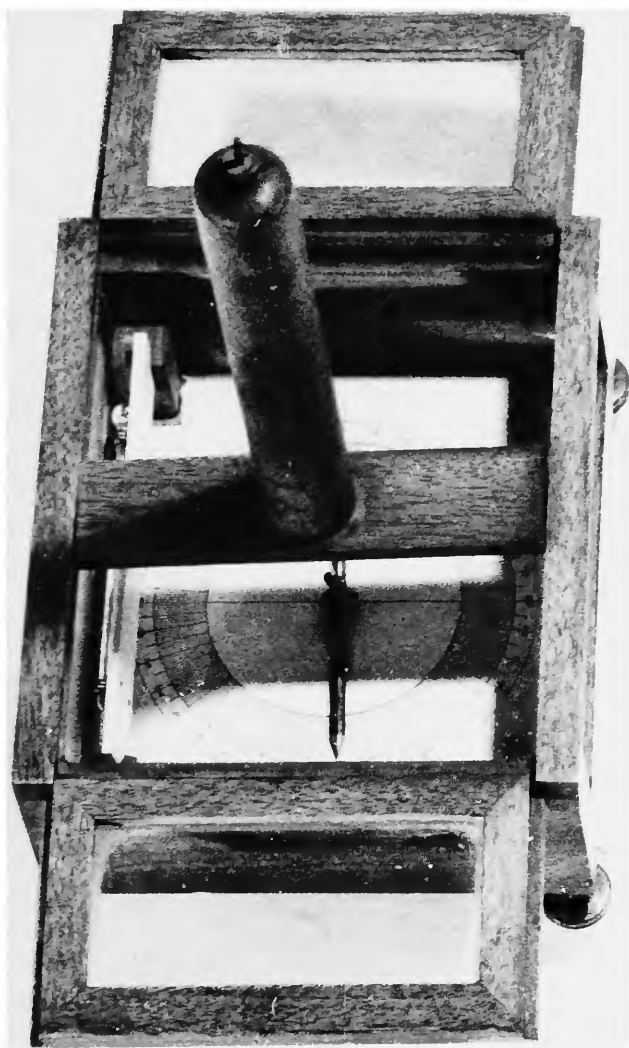

FIGURE 15.—An example of Hansteen's apparatus for measuring diurnal variation of the needle, preserved in the Geofysisk Institutt, Bergen University, Bergen, Norway. The instrument, viewed from above with the cover open, has a cylindrical magnet, made by Dollond, 2.8 in/72.8 mm long. The thread suspension is about 5.8 in/150 mm long. The instrument resembles that drawn in Hansteen's account of his work in Siberia (*Resultat Magnetischer, Astronomischer und Meteorologischer Beobachtungen-auf einer Reise nach dem ostlichen Siberien in den Jahren 1820-1830*. Christiana, 1863.)

ried to the astronomical observatory some distance away. Movement of the magnet induced a current in this circuit that moved a magnetic needle in the observatory. This "telegraphic signal" was the beginning of German work on telegraphy.

Gauss and Weber supplied copies of their instruments, made by Breithaupt of Cassel and Meyerstein of Göttingen, to other observatories in Bonn, Cracow, Dublin, Freiberg, Greenwich, Kazan, Leipzig, Marburg, Milan, Munich, Naples, and Upsala. They then organized the magnetic observatories of Europe, of which there were 23, into an association (Magnetische Verein) that issued published re-

#### Gauss, Weber, and Absolute Values

Gauss and Weber replaced conventional needles with long magnetized bars, in order to minimize the mutual influence of the north and south poles. They then addressed the problem that measurements of "magnetic force" (intensity) involve not only the magnetism of the earth but the magnetism of the compass needle itself, as well as its shape and weight, all of which vary from one compass to another. They solved this problem by making two different experiments, each of which led to an equation, and showing that these equations could be combined to eliminate as factors the magnetism, shape, and weight of the bar. The first experiment was simply the observation of the vibration of the bar. This gave the *product* of the earth's horizontal intensity and that of the bar ( $A = H \times f$ ). In the second experiment a second magnetized bar was placed in the stirrup and the first magnet was placed on a line perpendicular to the magnetic meridian. This magnet caused the suspended bar to deviate from its normal position by a certain amount, and the angles and distances involved indicated the ratio of the intensity of the same magnet (now stationary) to the earth's horizontal intensity ( $B = f/H$ ). By combining the equations they arrived at a number for the earth's magnetism in "absolute" units, mass, distance, and time ( $H = B/A$ ).

Gauss's method is indeed elegant on paper, but as Bauer noted in 1914, the procedure required about an hour and a half to accomplish. This, he said, posed the most serious problem to itinerant observers. A further difficulty was the fact that the pocket chronometers used in the vibration procedure were too delicate for rugged expeditions.

sults in six volumes between 1836 and 1841. After Weber's departure, Gauss finished his theoretical work, with a mathematical theory that contradicted and replaced the theory of Hansteen. It was based on the assumption that the terrestrial magnetic force is the collective action of all of the magnetized particles of the earth's mass, attracting and repelling each other with forces inversely proportional to the squares of their mutual distances, according to "an infinite theory of spherical functions." Gauss then lost interest in geomagnetism; he left not only a new theory, but he and Weber endowed their successors with some new instruments and, perhaps most important of all, with a clearer definition of what measurements were essential to a scientific analysis of geomagnetism.

The improvement of instruments continued. The Robinson instruments that had been used in the survey of Ireland were modified by Ross, the dip circle with a better pivot and the magnetometer by modifying the needle according



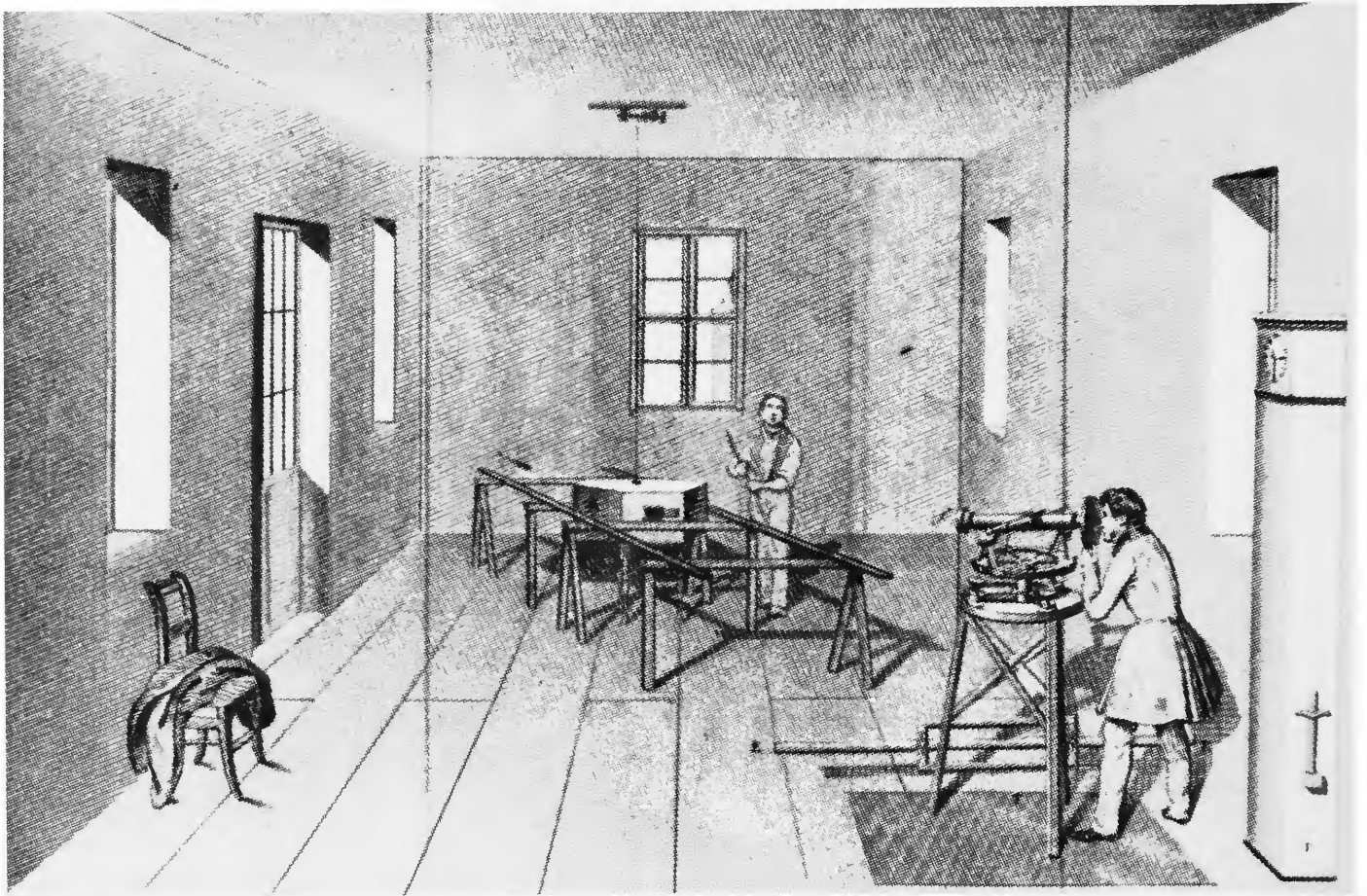

FIGURE 16.—The Gauss-Weber magnetic laboratory at Göttingen, showing the apparatus for declination.  
(From Becquerel, *Traité Complet de Magnetisme*, Paris, 1846.)

to “Mayer’s principle”—the latter referring to the rectification of the inevitable imperfections of fabrication through the addition to the needle of an adjustable weight for compensation. It had been introduced by Tobias Mayer in 1814. In Scotland R.W. Fox published, in 1835, results of observations with his “dipping needle deflector” (Figure 17), which measured variation, dip, and intensity, under various arrangements. Perhaps the first attempt at a “universal” instrument, it found wide use for the next fifty years. Because it increased the accuracy of measurements at sea, the analysis of instrumental errors and the refinement of observational procedures were greatly facilitated by Fox’s circle.

The innovations of Humphrey Lloyd were most lasting, notably his “induction-inclinometer” and his “vertical force magnetometer” (also called “balance-magnetometer”). In the former, which was a declination instrument used indirectly to measure inclination, a twelve-inch bar of soft iron was mounted vertically adjacent to a three-inch suspended needle. The bar becomes a weak magnet under the influence of the earth’s magnetism and deflects the needle accordingly. The tangent of the resulting “angle of deflec-

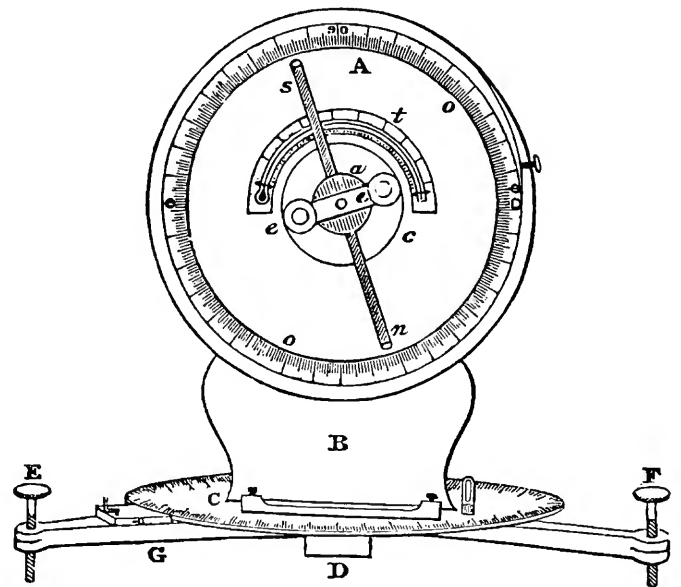

FIGURE 17.—Fox’s “dipping needle deflector,” introduced in 1835. (From *Annals of Electricity*, 3 (1839) Pl. V, fig. 47.) [Reference: T.B. Jordan, “Description and use of a dipping needle deflector invented by Robert Ware Fox,” *Ibid.*, pages 288–297.]

tion" is a measure of its inclination and its intensity. The vertical force magnetometer (Figure 18) embodied a "needle" resembling the beam of an ordinary chemical balance. Its tendency to dip was counteracted by a movable counterweight, and, by restoring its horizontal position with this weight, data was obtained that permitted the calculation of both dip and intensity. Moreover it indicated directly *changes* in the vertical force, and could be used to measure these changes from day to day or hour to hour, a measurement that was facilitated by its incorporation, by 1850, into the photographic self-registering magnetograph.

The principal German improver of instruments, Johann Lamont, was, curiously enough, a native of Scotland, from which he departed at the age of twelve as a pupil of the "Scottish Foundation" in Regensburg. He remained permanently in Germany, where he was eventually knighted. An astronomer with a particular interest in geophysics and in instruments, he found the instruments of Gauss and Weber erratic, in geomagnetic measurements made on a Bavarian mountain (Hohenpeissenberg), and became their severest critic. In 1835 Lamont became Director of the Bavarian astronomical observatory at Bogenhausen, to

which was added, four years later, a new magnetic observatory in Munich. There he devised for geomagnetism a new "system . . . apparently resting on laws, although not apparently connected with the form or peculiarities of the surface of the globe." It "fitted powerfully to excite the spirit of research," which he pursued in a laboratory that was ultimately credited with no less than 45 innovations in magnetic instruments. Many of his innovations, like those of Lloyd, related to the incorporation of fixed iron bars or permanent magnets, whose relationship to the movable magnetic needle gave data for the description of the geomagnetic situation in absolute units. Lamont also reworked the basic magnetometer of Gauss and Weber and finally reduced their 25 pound "needle" to one weighing a single gram.

The British Royal Astronomical Observatory at Greenwich had also begun the installation of instruments for geomagnetism in 1837, and in the next year the BAAS resolved to petition the government for 400£ to support magnetic observatories "in the various parts of the British dominions." The request was approved, and by 1840 observatories were established (although in most cases they were not yet functioning) at several of the locations pro-

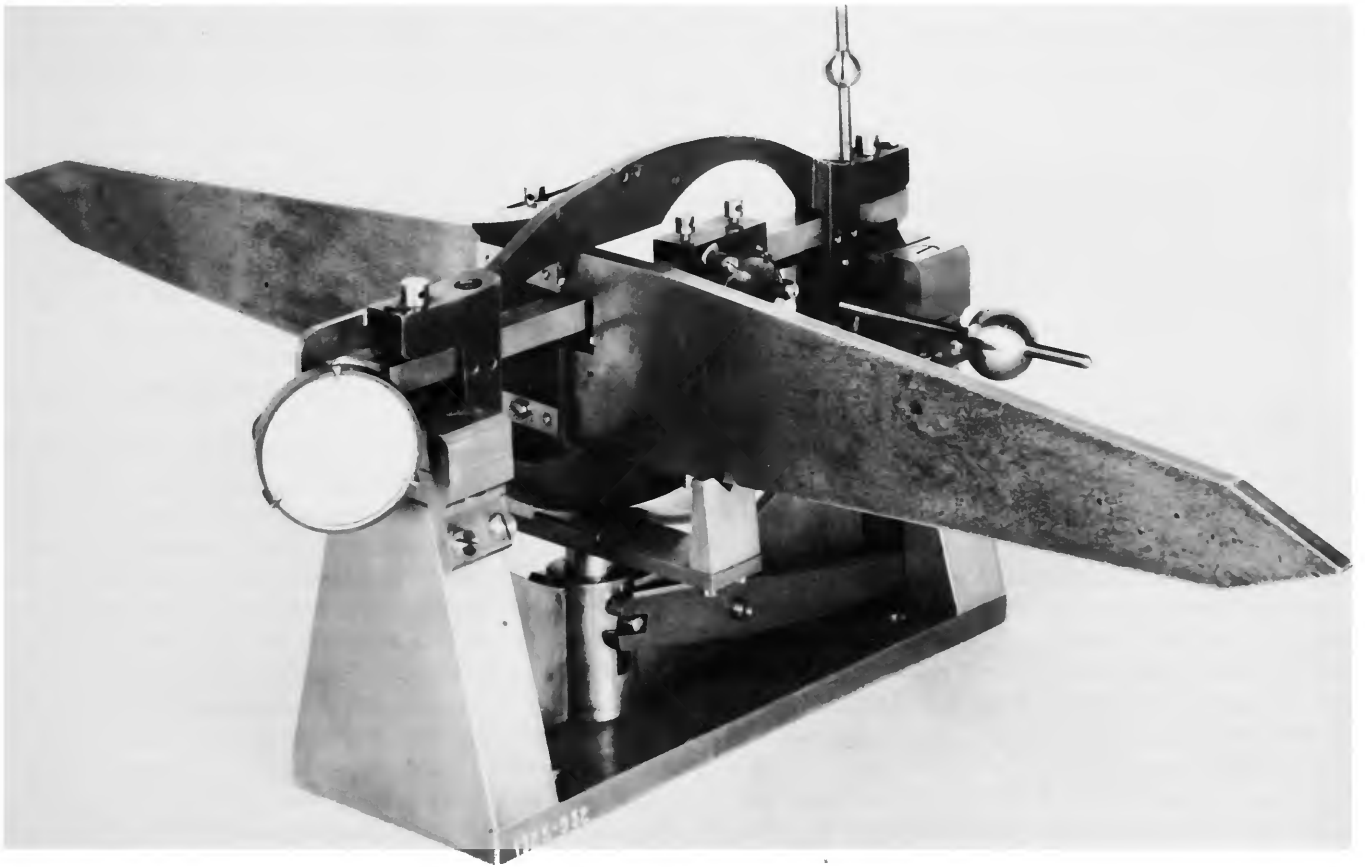

FIGURE 18.—Lloyd's "vertical force magnetometer" (or "balance magnetometer"), introduced about 1842. This example is in the National Maritime Museum, Greenwich, England, through whose courtesy it is reproduced here.

posed: Toronto, the Cape of Good Hope, St. Helena (a south Atlantic island), and Van Dieman's Land (Tasmania). The project had also inspired a number of others. Dublin had set up an observatory for Lloyd; the East India Company had established four; the "universities of Philadelphia and Cambridge" (Girard and Harvard Colleges) had established observatories in the United States; and even two Indian Maharajahs had established observatories. Others were set up, or planned, by the governments of Algeria, Bavaria, Belgium, Egypt, Prussia, and Spain. The Russian government now proposed no less than ten. Thus the British example reinforced Humboldt's injunctions to give terrestrial magnetism a firm footing as a subbranch of physical research.

About 1840 the Royal Society published *Instructions for the Use of the Magnetic and Meteorological Observatories and for the Magnetic Surveys* (we have used a revision of 1842), and in 1844 appeared a more comprehensive publication from the British Admiralty, *Magnetical Instructions for the Use of Portable Instruments Adapted for Magnetical Surveys and Portable Observatories*, by Lt. C.J.B. Riddell, the first Director of the Toronto Observatory. The instruments proposed by the former publication can best be identified in the following tabulation.

<i>Instrument</i>	<i>Description</i>	<i>Magnet</i>	<i>Purpose</i>
declinometer	thread suspended magnet.	15" bar	absolute declination.
bifilar magnetometer.	type of Gauss	same as declinometer.	variation of intensity.
unifilar magnetometer.	same as declinometer.	12" and 9" magnets.	absolute horizontal intensity.
inclinometer	no description		inclination (dip)
balance magnetometer.	Lloyd's (see above, p. 21)	12" needle	variation of vertical intensity

It might be supposed that Riddell's *Magnetical Instructions*, stressing portability, would be simpler. However, after he notes that a magnetic survey can be made with only two instruments, a dip circle and a magnetometer, he goes on to describe a bewildering variety of instruments—at least with respect to their names. This is perhaps sufficiently indicated by his immediate observation that the "magnetometer" can either be a "theodolite magnetometer" or a "portable unifilar magnetometer with a portable declinometer." They were commercially available (see Figure 19) from Thomas Jones and (Henry) Barrow of London, and from a Mr. George of Falmouth.

Riddell also printed the forms for recording observations, which were to be taken at times rigorously specified in terms of Göttingen mean time. "Regular observations" were taken hourly, not only of all instruments (except for the dip circle, which was observed twice weekly) but of several meteorological instruments, the whole to be accomplished

within the two minutes before and after the hour. "Term observations" were taken monthly, and "extraordinary observations" when marked change was noticed, especially during the aurora. "Absolute determinations" were made on occasion, as a check on the "differential instruments," at least once each half-year in a fixed observatory.

Thus the single observer, who is the object of the above instructions, can be pictured as busy, and a producer of paper records that put those of eighteenth-century observers beyond the pale. The primary object was the determination of absolute values of declination, inclination, and horizontal intensity at different stations, a calculation that required three or four hours.

This was roughly the apparatus supplied to Lt. Lefroy in 1842 for the magnetic survey of Canada, which ranged from Montreal to Lake Athabasca and ended at Toronto where a permanent observatory was established. Lefroy replaced Riddell as Director, and the names of the instruments do not correspond precisely to those in Riddell's *Instructions*. Indeed, two descriptions of Lefroy's instruments do not correspond with each other. One mentions the inclusion of a Gambey inclinometer and a Fox inclinometer of seven inches diameter. A dip circle made by George of Falmouth, as designed by Fox, mentioned in the other account, may be the same instrument, but this account also mentions a portable declinometer of Weber's construction (which was later replaced by an instrument designed by Riddell and made by Jones).

As part of the British enthusiasm for magnetic studies, the Royal Observatory at Greenwich had already constructed a magnetic observatory in 1837. It possessed a "meridional magnet" and, by 1840, a bifilar magnet for variations of horizontal force. The former was based on a Simms theodolite and incorporated a two-foot-long magnet made by Meyerstein of Göttingen. The instruments would appear to be those specified by Gauss, and to have been themselves the prototypes of those specified for the new observatories.

As is evident from the instructions published by the Royal Society and the British Admiralty, increased accuracy of measurement was by the mid-nineteenth century no longer the sole focal point of research in instrumentation. Scarcely less important was measurement of short term (diurnal) and long term (secular) changes, which were found to occur wherever magnetic measurements were made for any length of time. Riddell's busy observer was expected to keep track of them. However, this new, arduous, and record-inflating task virtually coincided with its solution, the development of automatic photographic recording. In 1846–1847—scarcely a decade after the introduction of photography—Charles Brooke of the Greenwich Observatory and Francis Ronalds of the Kew Observatory introduced apparatus for the photographic registration of thermometers and barometers, and very shortly afterward of the position of the needle in geomagnetic instruments (see Figure 20).

PRICES OF INSTRUMENTS.

Instruments\* made by Mr. Thomas Jones, 62, Charing Cross.

	£.	s.	d.
Portable Declinometer,† with Apparatus for experiments of deflection, and Stand . . . . .	14	0	0
Ditto with an additional table top, capable of carrying both the Theodolite and Declinometer . . . . .	15	2	0
2 Five-inch Altitude and Azimuth instrument, divided to 30', with transit axis, diagonal eye tube, Lamp, &c. . . . .	21	10	0
Triangular Stand . . . . .	2	10	0
3. Portable Unifilar Magnetometer‡ and Stand . . . . .	22	10	0
4. Theodolite Magnetometer and Stand . . . . .	30	0	0
5. Portable Declination Magnetometer and Stand . . . . .	12	0	0
6. Portable Bifilar Magnetometer, (with socket arms and two soft iron cylinders, to enable it to be used as an Induction Inclinator, if so required,) and Stand . . . . .	19	10	0
7. Induction Inclinator, for a fixed or portable observatory . . . . .	15	0	0
Portable Stand . . . . .	2	10	0
Additional reading Telescope and Scale to be used in a fixed observatory . . . . .	3	13	6
8. Observatory Unifilar Magnetometer, with Apparatus for experiments of deflection and vibration, reading Telescope, long scale, &c. . . . .	14	10	0
9. Observatory Bifilar Magnetometer, reading Telescope, &c. . . . .	11	0	0

\* The instruments which are to be ordered from this list for a magnetic survey are Nos. 1 and 2, Nos. 1, 2, and 3, or No. 4; for a magnetic survey and complete portable observatory, with separate differential instruments, Nos. 1, 2, and 3, or No. 4, with Nos. 5, 6, and 7; and for a fixed observatory, Nos. 1 and 2, or No. 4, and Nos. 7, 8, and 9. The prices of the different instruments include the spare and additional apparatus mentioned in the specifications, with the exception of the outer cases for the observatory differential instruments.

† The Portable Declinometer may be constructed at a less expense, omitting the second magnet and the apparatus for experiments of deflection.

‡ The cost of the Portable Unifilar, or of the Theodolite Magnetometer, will be increased by about 5*l.* or 6*l.*, if the instrument is made available for observations both of inclination and horizontal force, and by about 2*l.* or 3*l.* if made available for only one of these purposes.

Instruments made by Mr. Barrow, 26, Oxenden-street, Haymarket.

	£.	s.	d.
9½-inch Dip Circle . . . . .	25	0	0
6-inch ditto . . . . .	15	15	0
5-inch Prismatic Compass, with a compound bar card, ruby cap, stand, &c., complete (the prism either direct or inverting) . . . . .	5	0	0
A pair of Lloyd's intensity Needles for the 9½-inch circle . . . . .	5	0	0
Ditto for the 6-inch circle . . . . .	3	3	0

Instruments made by Mr. George, Falmouth.

Fox's Dip Circle and Intensity Apparatus, with spare jewels and an additional pair of deflectors . . . . .	26	2	0
------------------------------------------------------------------------------------------------------------	----	---	---

FIGURE 19.—Price list of instruments offered by Thomas Jones and Mr. Barrow of London and Mr. George of Falmouth, in 1844. (Printed in C.J.B. Riddell, *Magnetical Instructions for the Use of Portable Instruments*, London, 1844.)

North American Research<sup>4</sup>

The discovery of the Americas more or less coincided with the first observations of variation/declination of the magnetic compass; indeed, Columbus is supposed to have observed variation during his initial voyage, and the observations that aroused Humboldt's interest in the subject were made in South America. In North America John Winthrop (d. 1779) collected observations that reportedly went back to 1672.

Nathaniel Bowditch published observations as early as 1815 and in 1829 the *American Journal of Science* printed contradictory articles on geomagnetism, by Bowditch and Simon de Witt. The field soon became as lively in the United States as in Europe. Hansteen had given one of his magnetometers to Sabine, who, replacing Hansteen's needle with

one of his own, gave the apparatus to James Renwick, professor of natural philosophy at Columbia College. Renwick in turn sent it to Joseph Henry, at Albany, who exhibited it at the local Academy in 1830. Henry also made experiments on "dip" in 1830, apparently using an apparatus similar to that of the Royal Society. In 1834 a "dipping needle" made by Gambey "for the apparatus of the Military Academy" (West Point), was used for joint observations by Professor E.H. Courtenay of the Academy and Alexander Dallas Bache, an Academy graduate who was then teaching at the University of Pennsylvania. Bache was also using in 1836 an instrument similar to Hansteen's design, which appears to have been "home made," as was another, consisting of a needle suspended in an evacuated glass jar, to test the effect of air resistance.

During that decade a group of American scientists tried

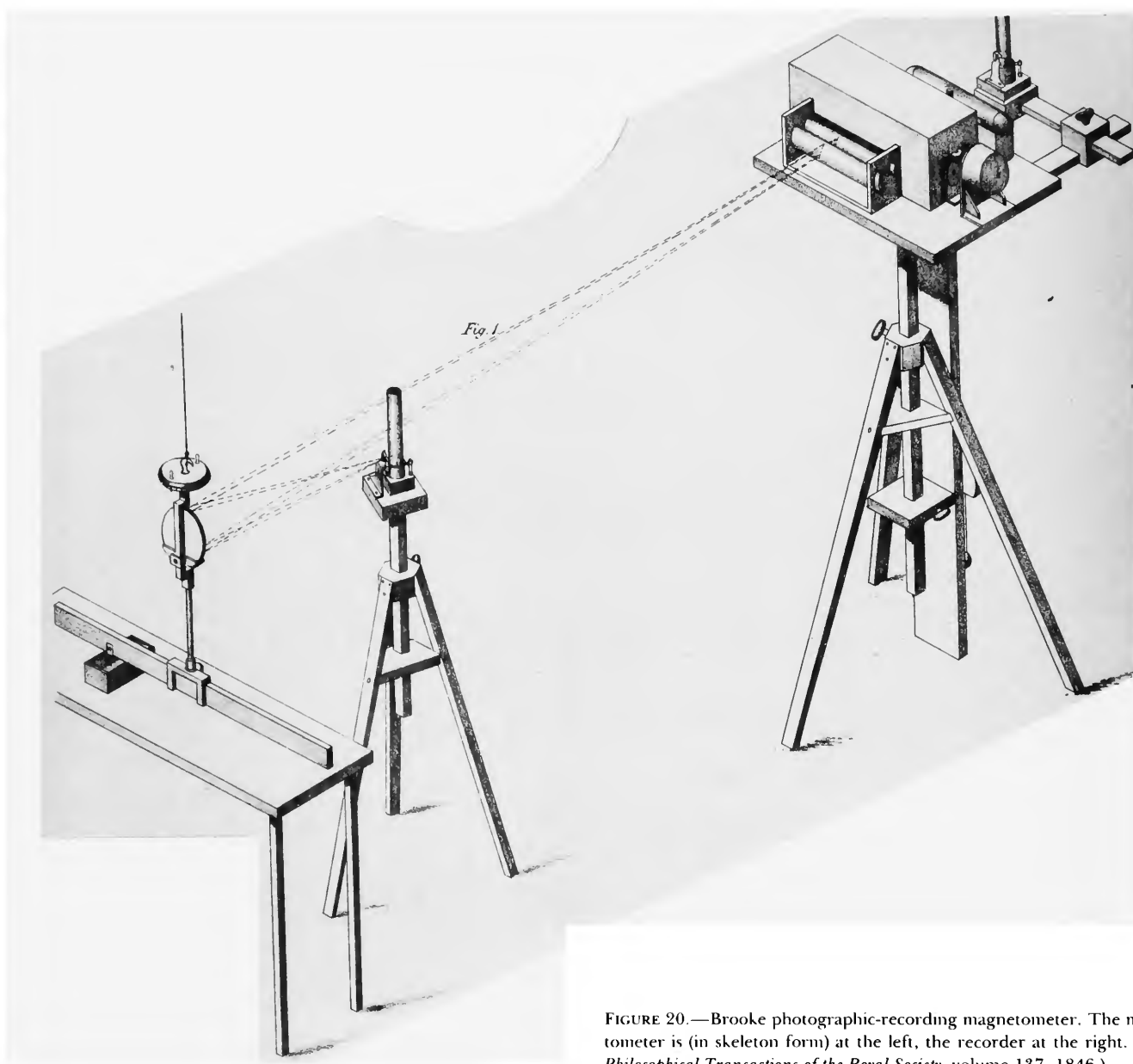

FIGURE 20.—Brooke photographic-recording magnetometer. The magnetometer is (in skeleton form) at the left, the recorder at the right. (From *Philosophical Transactions of the Royal Society*, volume 137, 1846.)

to form a private association for a general magnetic survey of the United States. It evolved out of the individual efforts of Elias Loomis (first at Yale, then at Western Reserve College), John Locke (of Cincinnati), Bache, James Renwick, and a half-dozen others. Loomis circularized state surveyors and professors in an attempt to produce a chart of declination, reduced to the epoch of 1838. As for inclination, he noted that few American researchers had suitable dip circles. But Locke included that measurement in the results of his survey of the declination and dip in Ohio, the first survey west of the Alleghenies, having observed from 1838 to 1845 with Robinson instruments and "Weber's improved transportable magnetometer," which he obtained in Lon-

don. His objective was to establish Cincinnati as the base point, linked to the new Toronto observatory.

While at Yale, Loomis had measured declination with a Dollond theodolite that had an enlarged magnetic compass. When he moved to Western Reserve he added to his equipment a Gambey dip circle, for an expanded survey of Ohio and Michigan. From an analysis of his and Locke's results Loomis concluded that the dip circle was "one very ungrateful instrument," for even when they took all possible care—inverting and reversing the needle, using more than one needle, etc.—an error of 15.5 minutes of arc was found unavoidable.

In 1836–1838 Bache, who had been made President of



the newly founded Girard College in Philadelphia, traveled to Europe for the college, making geomagnetic observations along the way (at 21 stations) using a dip circle by Robinson. It may have been at this time that Bache acquired the magnetometer by Gambey, which he used in 1840–1843 in his magnetic survey of Pennsylvania, and which is now in the Smithsonian (No. 2, Figure 32).

Bache proposed in 1838 that Girard College construct a special iron-free building for use as a magnetic observatory, to incorporate instruments he had selected for the college during his European tour. His observatory magnetometer, made by Meyerstein, was another after the Gauss pattern, a unifilar instrument that was read by reflection and was part of the building itself. He also used Lloyd's vertical force magnetometer with a twelve-inch magnet made by Robinson. Bache donated another of these magnets to the Naval Department of Charts and Instruments in 1841 and cooperated extensively with observatories at Harvard and Toronto during the life of the Girard Observatory, which was closed in 1845.

At Harvard, W.C. Bond and Joseph Lovering had used dip circles by Gambey and by Troughton and Simms, but like Loomis before him Lovering complained that even the best dip circles could vary by fifteen minutes of arc between instruments. By 1846 the Harvard dip circles were in the hands of Major J.D. Graham for his survey of the boundaries of the country, while the Cambridge observers, hoping for a more accurate indirect method, acquired the instruments recommended by the Royal Society to the British Colonial Observatories, including Lloyd's vertical force magnetometer.

The Harvard instruments were acquired with the assistance of the Americal Academy of Arts and Sciences (Boston) and of the federal government, which also obtained instruments for the Military Academy and the "United States Exploring Expedition" (1838–1842) headed by Lt. Charles Wilkes. Lt. James Gilliss conducted simultaneous geomagnetic measurements in Washington at the Naval Depot, although he found himself limited to a declinometer resembling "an ordinary surveyor's compass," and a dip circle "rendered hors du combat from a bend of its pivots," both made in 1828. He replaced them in 1840 with a new declinometer designed by Gambey, but made by Simms, and a new dip circle apparently from the same maker.

When Gilliss visited Europe in 1842–1843 to obtain books and instruments for the Depot, which was about to become the United States Naval Observatory, he was still seeking better instruments. He reported "a great diversity of opinion" respecting the most suitable dimensions for "magnetical" instruments, and declared that "it was with difficulty that I resolved to order any."

Professor Gauss, at Göttingen, with 25 pound bars, was at one extreme; Dr. Lamont, at Munich, with needles 2½ feet long, made of chronometer

spring (probably a misprint or misstatement, referring to experiments by Lamont in using a chronometer spring to dampen the movement of the needle) and weighing about half an ounce, was at the other; whilst the committee of the Royal Society were intermediate.

He finally decided "to copy the instruments made for the English observatories, differing from them only in points recommended by Professor Lloyd and Colonel Sabine." They were ordered from Henry Barrow, who succeeded Robinson after the death of the latter in 1841, and were made under the supervision of Sabine's assistant, Lt. Riddell, author of the aforementioned *Magnetical Instructions*. Like that used by Lefroy in Canada, Gilliss' apparatus varied slightly, both in the instruments actually used and in their dimensions, from Riddell's *Instructions*.

In his book on the Girard College observations, Bache reported having replaced his Lloyd vertical force magnetometer with a similar instrument made by Joseph Saxton, a Philadelphia "mechanic" who was to become one of the most important, and certainly the most versatile, American instrument-maker of the nineteenth century. This apparently occurred during Bache's observations of 1840–1845, and it may have been the first really significant geomagnetic instrument of American construction. Apparently it no longer exists, nor does its principal rival for this honor, a dip circle made by another Philadelphia mechanic, Isaiah Lukens, in 1819. The earliest American-made instruments in the present collection are a dip circle (No. 31, Figure 61) by William Wurdemann of Washington that was in use by 1863, and a magnetometer (No. 6, Figure 35) by William Grunow, a German immigrant who was active as an instrument-maker in New York City from 1861.

In 1844 Bache became head of the U.S. Coast Survey, and two years later the Smithsonian Institution opened its doors, with Joseph Henry as its first head (Secretary). With two enthusiasts in strategic positions, Washington not surprisingly emerged as a center of geomagnetic research. The Coast Survey had been founded in 1816, under the direction of F.R. Hassler, a Swiss immigrant scientist. Hassler was soon in conflict with the Congress over appropriations, particularly the cost of instruments; but they had nothing to complain of with regard to his magnetic work, which appears to have been little more than a magnetic reconnaissance of Connecticut and New York in 1833, made with an ordinary "azimuth compass." By the time Bache succeeded Hassler, on the death of the latter in 1843, the activity of the Coast Survey had been largely restricted to conventional geodetic surveying. However, the practice of taking observations was resumed by Bache and became increasingly important during his 24-year tenure as Superintendent. Measurement of declination, dip, and absolute horizontal intensity, with "a set of Riddell's portable magnetic instruments," made by (Thomas?) Jones of London, and a dip circle by "Patton" of Washington, is mentioned in 1844.

The same instruments are mentioned in successive years, although Patton's dip circle seems to have been supplanted by one of Barrow's. By 1849 the Survey had begun to number its instruments, dip circle no. 1 being a Jones instrument, perhaps from the "set" just mentioned. Also mentioned are dip circles by Gambey (with a ten-inch needle) and one or more others by Barrow (the Survey's no. 9, a Barrow instrument with a six-inch needle, is in the present collection [No. 30, Figure 60]). The Survey *Report* for 1847 mentions a magnetometer, described as "Weber and Riddell's portable declinometer," and that for 1851 refers to "a portable declinometer of Gauss and Weber as arranged by Professor Lloyd and Colonel Sabine, and made by Jones."

A "Table of Magnetic Results," published by the Survey in its *Report* for 1881, lists observations dating from the 1830s and gives some indication of the instruments used. Most of the Survey's early observations were made with instruments borrowed from other sources, notably the Smithsonian and the Naval Observatory. A Barrow dip circle no. 4 is mentioned in use in various locations into the 1870s (it was used in Central Park, New York City, in 1872). The aforementioned Wurdemann dip circle was still in use in 1881, when it was carried down the west coast, from Sitka to San Diego.

Smithsonian interest in a "magnetic survey" was mentioned as early as its second *Annual Report* (1848), when Joseph Henry visited Lefroy at his Toronto observatory. Henry subsequently ordered a set of magnetic instruments from London. It was the first of several sets, for the Smithsonian became the source of instruments used on expeditions. When Lt. Gilliss set sail for his Chilean solar parallax expedition of 1849 he had a set of magnetic instruments purchased for him by the Smithsonian (which was paid for by a special Congressional grant). Another set had been received by 1851 and was lent to (now) Colonel Graham for use on the Mexican Boundary survey. By 1853 the Smithsonian had four sets, another of which was lent to Dr. Kane for the Grinnell expedition to the Arctic. Kane returned these in 1856 and they were lent to Baron Muller for use in Mexico and Central America, where, according to Henry (but probably erroneously) no observations had been made since Humboldt. Subsequent reports note Muller's long silence and finally the loss of the instruments, "captured and destroyed by robbers." They also identify the set, a small theodolite, a declinometer, a unifilar magnetometer made by Jones, and a Barrow dip circle.

The Smithsonian also had its own observatory, a specially constructed underground room that in 1853 was supplied with at least part of a set of the photographic recording instruments devised by Brooke, consisting of a declinometer (a steel bar supported by "several" silk threads), a bifilar intensity instrument, and an inclinometer supported on knife edges (probably Lloyd's vertical force magnetometer)

(see Figures 21 and 22). The *Report* for 1860 mentions the receipt of the "remaining" Brooke instruments; but it also reports the conclusion that the observations in Washington were nearly the same as those in Toronto and Philadelphia. Henry, who lacked the empire-building instinct, dispatched the instruments (except for one) to a more appropriate site, Key West, Florida.

The Smithsonian observatory had been a joint venture of the Institution and the Coast Survey, and so was the one at Key West. However, the Smithsonian was leaving the field of geomagnetic research. Its instruments were apparently transferred to the Coast Survey, for when I.I. Hayes made an expedition to "the arctic seas" in 1860 he borrowed instruments from the Coast Survey, a magnetometer by W. R. Jones and the aforementioned Patton dip circle, which had been improved by new needles by William Wurdemann, now an employee of the Survey.

In the *Report* for 1857 Bache listed 160 "magnetic stations" at which observations had been made. Lines of equal declination (isogonic lines) had been mapped for the coastline by 1855 and were to be extended by 1875 to the whole country. The most imposing instrument remained the Brooke magnetograph, which was moved from Key West to Madison, Wisconsin, in 1876. In 1882 the Coast Survey acquired an improved magnetograph, an example of the instrument designed shortly before by Patrick Adie for the Kew Observatory (see Figure 23). The instrument was installed at its new observatory in Los Angeles, where its bulk and marble pillars (see Figure 36) were reminiscent of Duhamel's "sculpture garden" of a century earlier.

### A "Quiescent Period"?<sup>5</sup>

The movement for the establishment of "permanent" observatories seems to have declined, after peaking in 1841, when twelve were inaugurated. Only two were set up in 1842 and few others during the next generation. The fervor that had attended the founding of Gauss' Magnetische Verein and of the British Colonial Observatories died away, as did, in the course of time, their promoters, Weber, Lamont, Lloyd, and Sabine. They were not to be succeeded by enthusiasts of equal influence.

This has been seen as the beginning of a quiescent period in the study of terrestrial magnetism, lasting until about 1900. There is, however, plenty of evidence to the contrary. Observation did not slacken after the 1840s; in fact, it proliferated. On the one hand differences in geomagnetic direction and force from place to place made the subject an adjunct to the geodetic survey. On the other hand, diurnal and secular variation made evident the similarity between geomagnetism and that other recalcitrant science, meteorology, and numerous meteorological observatories became also magnetic observatories. Thus geomagnetism was in a sense absorbed by related and more venerable fields.

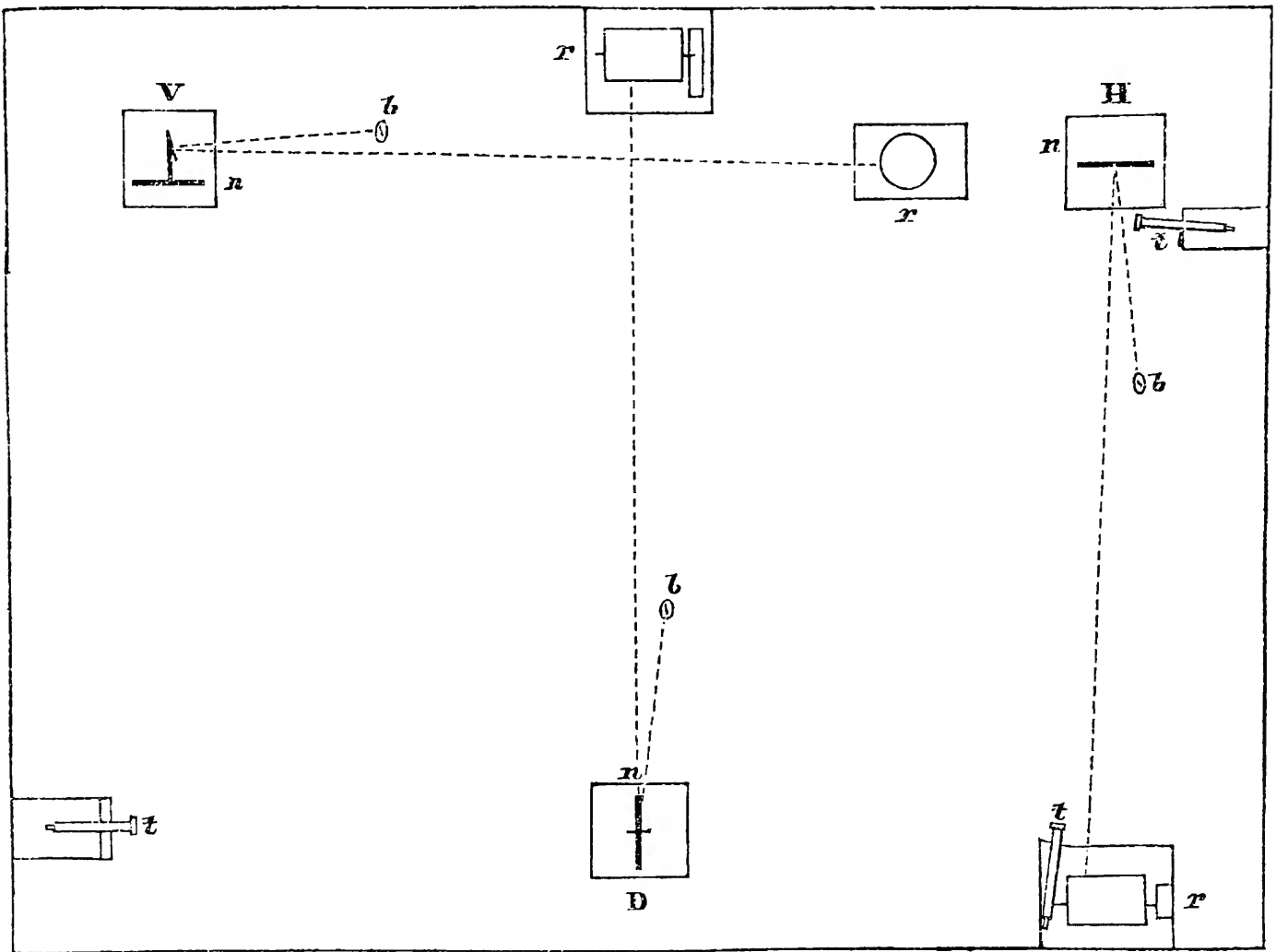

FIGURE 21.—Plan of the magnetic room of the Smithsonian Institution, 1860, showing the locations of the declination magnet (D), horizontal force magnet (H), and vertical force magnet (V). The "b's" are gas lamps, the "r's" photographic recording cylinders. The distances from the reflecting mirrors to the recording cylinders is 9 ft, 6 in/2.9 meters. (From Smithsonian Institution *Annual Report for 1860*.)

The Brooke magnetometer was moved to Key West in 1860, the first of several moves. According to the Coast Survey *Report for 1884* it was still in use, at Point Barrow, Alaska.

It is to this supposedly quiescent period that most of the older instruments in the present collection belong. The Coast Survey instruments appear to have been long-lived and widely used. Its instrument department was mainly involved in their repair or modification—a circumstance that raises the question of the resemblance of the extant instruments to their original forms. (In 1883 the Survey participated in an International Polar Expedition with a magnetometer "hastily constructed from some remains of an earlier instrument".) American geomagnetic equipment continued to be primarily of English origin, although in the 1880s the Survey acquired and tried out instruments of the French and German magnetic surveys. These instruments

survive, in part, certainly, because they failed to satisfy the notions of the Americans as to what an instrument should be. These instruments do seem to betray their national origins, the French being jewel-like in their elegance and diminutive size, and the German instruments being marvels of complexity and bulk. It was claimed that the German instruments were "portable," but the Americans almost invariably used them in fixed observatories.

The Coast Survey showed a decided preference for the instruments of the "Kew (Observatory) type," as made by the firm of Dover. But American-made instruments did exist, as has been noted. Another special Congressional appropriation, this one for observations in connection with

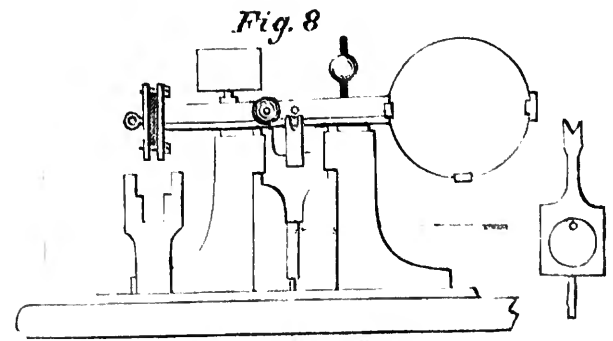
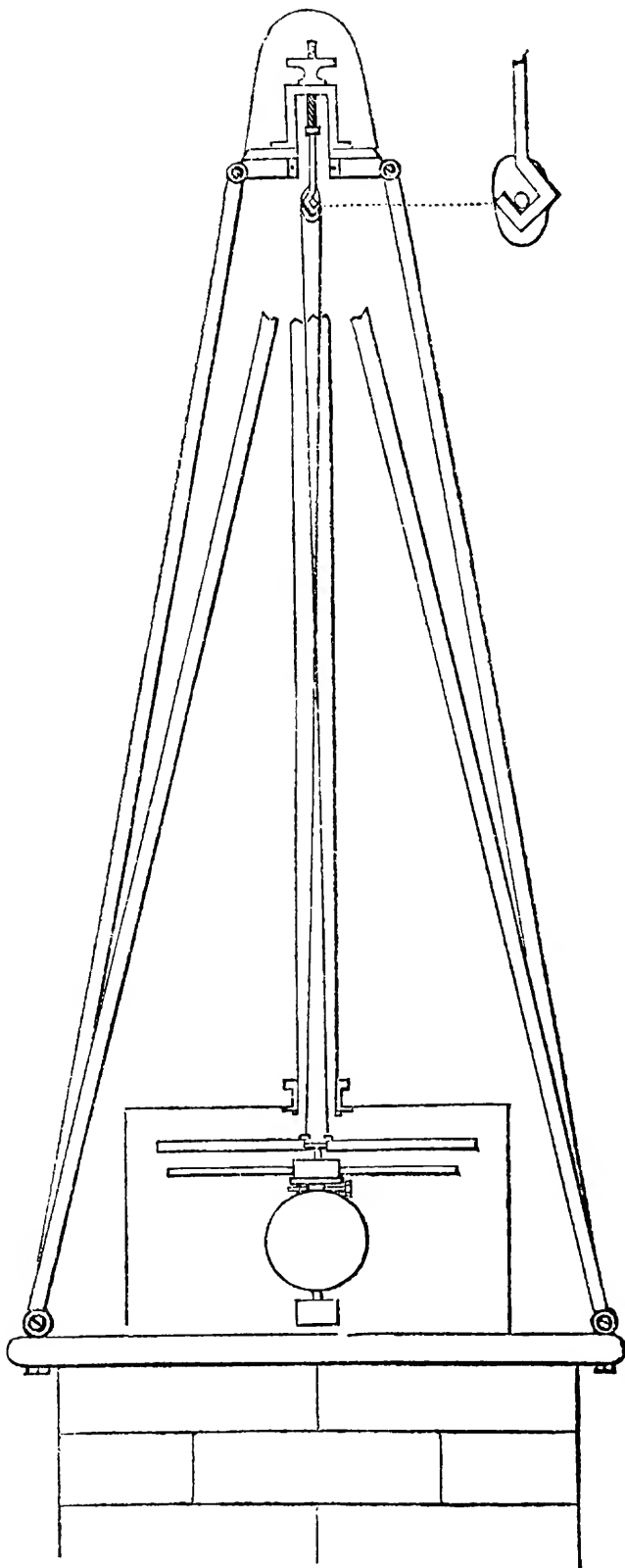

FIGURE 22.—Instruments in the Smithsonian magnetic room. Right: "Vertical force instrument or balanced magnetometer." Above: bifilar magnetometer, "after Gauss' design." Note the 90° twist in the two suspension fibres. (From Smithsonian Institution *Annual Report* for 1860.)

the transit of Venus on 8 December 1874, included funds for a dip circle that survives in the collection (No. 32) and was apparently made by the shop of the Naval Observatory. Finally, in the late 1870s the Coast Survey ventured into the design of its own instruments, "with a special view of making them more portable than the older instruments, which were found unnecessarily large and heavy." From this time it is possible to speak of a typical Coast Survey instrument (see Figures 24–27, and No. 11, Figure 39).

A new era of international scientific cooperation also began at this time. For example, the transit of Venus just mentioned saw the establishment by the United States and Britain of temporary observatories around the Pacific. Geomagnetism was only a secondary objective in this case, but for the first International Polar Year (1881–1882) thirteen circumpolar observatories were set up explicitly for geomagnetism, by Denmark, Germany, France, Britain, Finland, and the United States.

The result was hardly commensurate with the objective because the effort was hastily organized. Most stations were ill-equipped, and many began their observations late or omitted some of the required measurements. Only the French had self-registering instruments. Worst of all was the failure of the supporting nations to supply funds for the analysis of the observations, an undertaking that lacked the romance and national prestige attached to expeditions. Nevertheless, there were published results, which occupy about five feet of shelf-space, and have proven to be important for the study of electrical effects in the Polar atmosphere during the aurora and of the propagation of magnetic disturbances. This international venture prepared the way for improved expeditionary research in the 1890s.

Kew Observatory remained doggedly vigilant in maintaining standards for instruments. Its staff, between 1853 and 1897, tested and calibrated 21 magnetographs, 117 unifilar magnetometers, 155 dip circles, and a number of collimating magnet tubes and dip needles. It also trained observers and continuously monitored the magnetic elements, as a basis for measurements elsewhere in Britain. Lastly, it allowed scientists from the continent and the

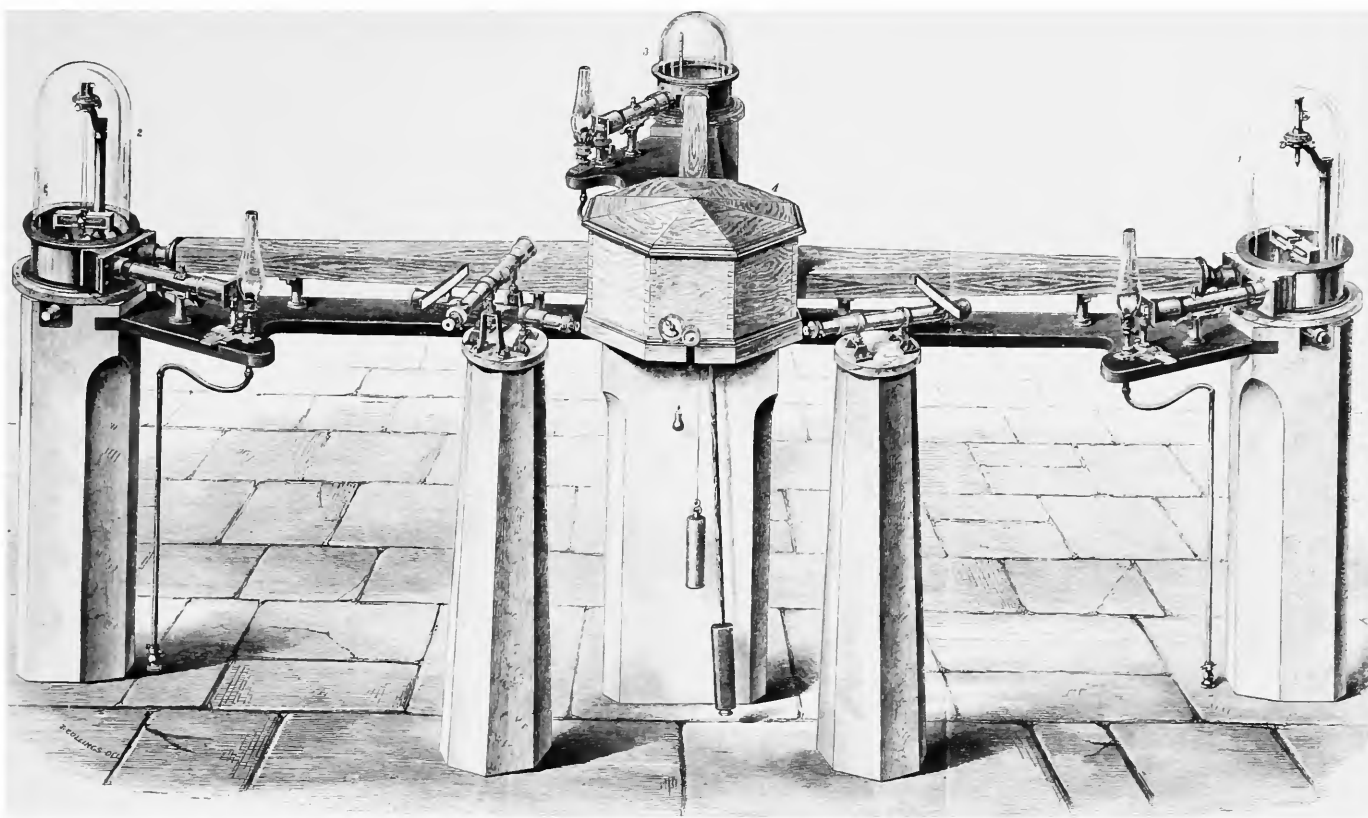

FIGURE 23.—Adie magnetograph. This photo-recording instrument, first described in 1859, was designed by J. Welsh at Kew Observatory and made by the London instrument-maker, Patrick Adie. It is similar, with improvements relating primarily to the photographic registration, to the Brooke magnetograph acquired by the Smithsonian in 1853. The latter no longer exists, but the present collection includes an Adie magnetograph acquired by the Coast Survey in 1882 (No. 8, Figure 36).

Three magnetic sensing elements, for changes in declination and in both components of magnetic force, rest on individual 15½-in/39.4-cm square marble plates. The octagonal box is the photo-register. (From J. E.H. Gordon, *A Physical Treatise on Electricity and Magnetism*, New York, 1880.)

United States to compare their own instruments with British standards, thereby increasing the values of surveys generally.

The United States Coast Survey became the Coast and Geodetic Survey in 1878, thus obtaining formal sanction for magnetic work in the interior of the country. In the same year, the state of Missouri began the first comprehensive state (although it was privately financed) magnetic survey since the 1830s. Surveys were also sponsored by the National Academy of Sciences (1871–1876), by the United States Lake Survey, and by the army, in the Indian Territories.

The geodesists' determination to realize a systematic survey of the earth was achieved by deferring consideration of a number of puzzling side effects. There was the effect of the aurora borealis on terrestrial magnetism, which had been given a scientific basis by S.H. Christie in 1831, and the erratic behavior of instruments during "magnetic storms," which had been noticed in 1834. In the 1840s

Lamont had found that declination changed in a ten or eleven year cycle, and that this had some degree of correspondence to a recently discovered cycle in the frequency of occurrence of sunspots. In 1851 Sabine claimed that the daily magnetic changes were really composed of two different changes, one within the earth, the other outside of it. In 1861 Lloyd demonstrated the existence of electric currents, and hence magnetic currents, in the earth's crust.

These accumulated peculiarities provided material for study by the permanent observatories, which turned, during this "quiescent period," to the systematic recording of periodic and unusual magnetic phenomena. For this the photographic recording technique was ideal, but the conventional declinometers and inclinometers to which it was originally applied were not. Sensitivity to change, not extreme accuracy, was the primary consideration. The sensing instruments were accordingly redesigned, usually into sets of three, for declination, horizontal force, and vertical force. In recognition of their special purpose and relative charac-



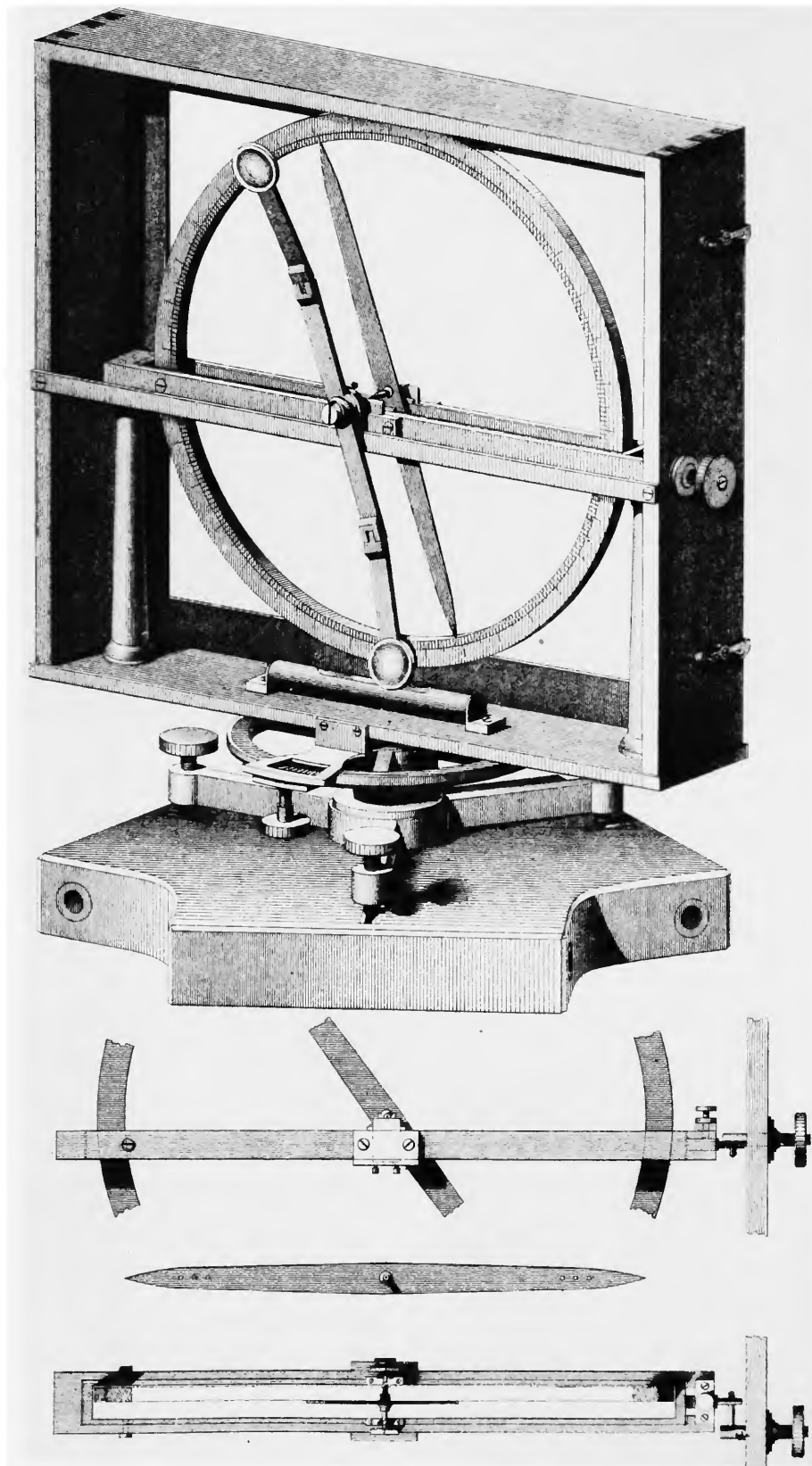

FIGURE 24.—Dip circle represented as "typical" in the *Report of the Coast Survey for 1875*. In the present collection it is exemplified by No. 30 (Figure 60).

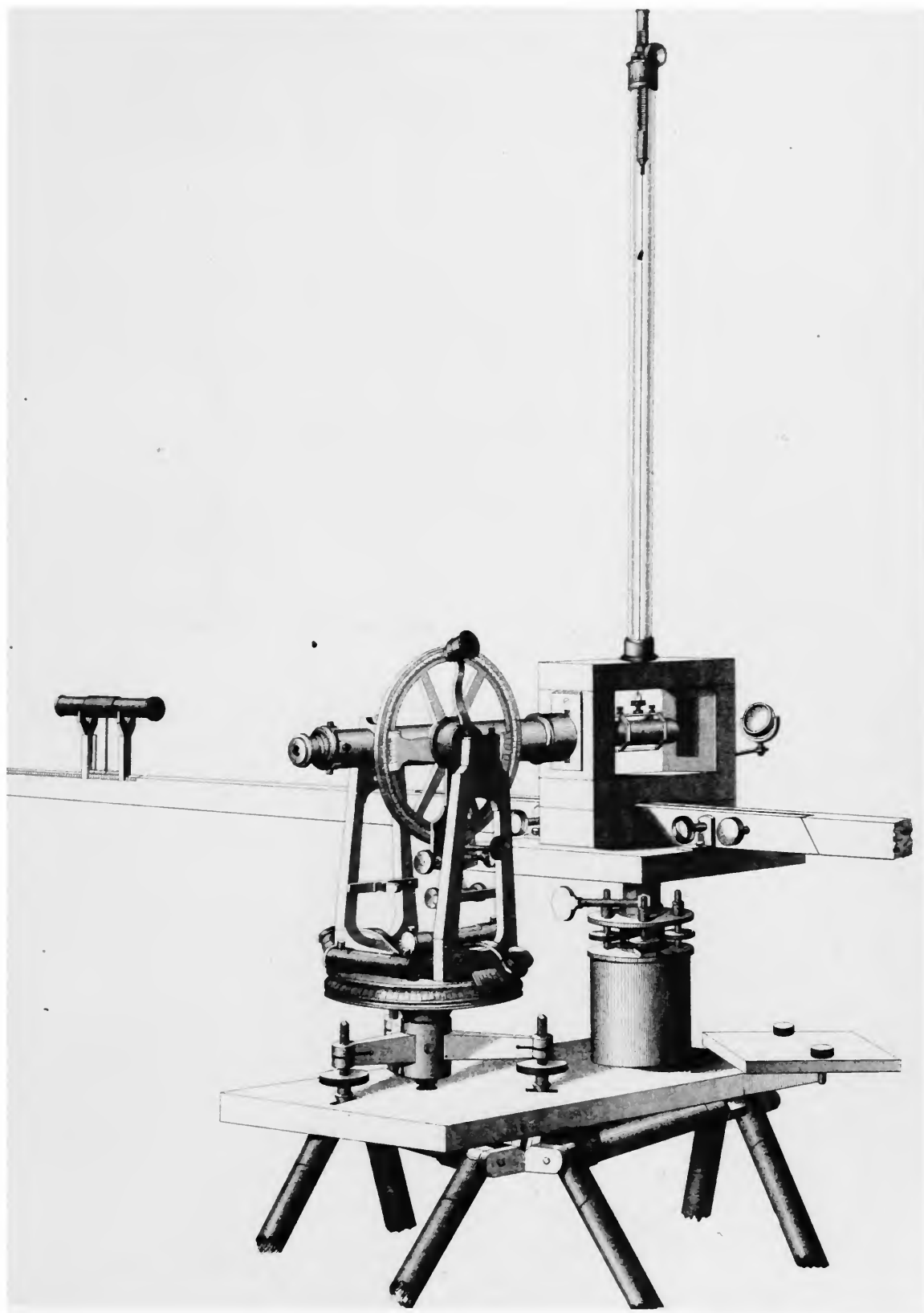

FIGURE 25.—Magnetometer, with theodolite, of a type used by the Coast Survey as illustrated in its *Report* for 1881, and described as "Weber's design." It is not represented in the present collection.

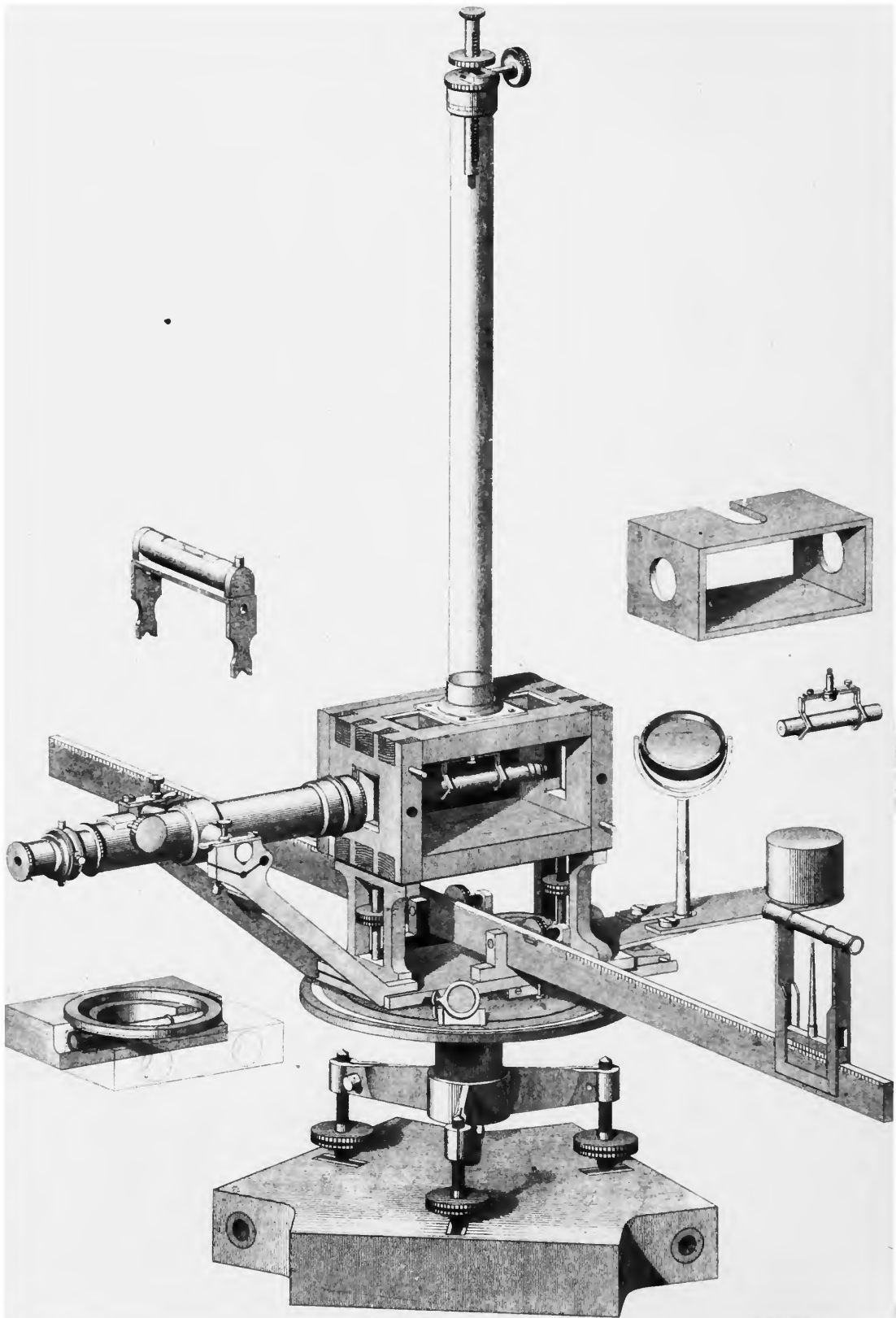

FIGURE 26.—Magnetometer, also illustrated in the *Coast Survey Report* for 1881, and described as "Lamont's design."

**MAGNETOMETER  
AND  
ALTAZIMUTH INSTRUMENT**

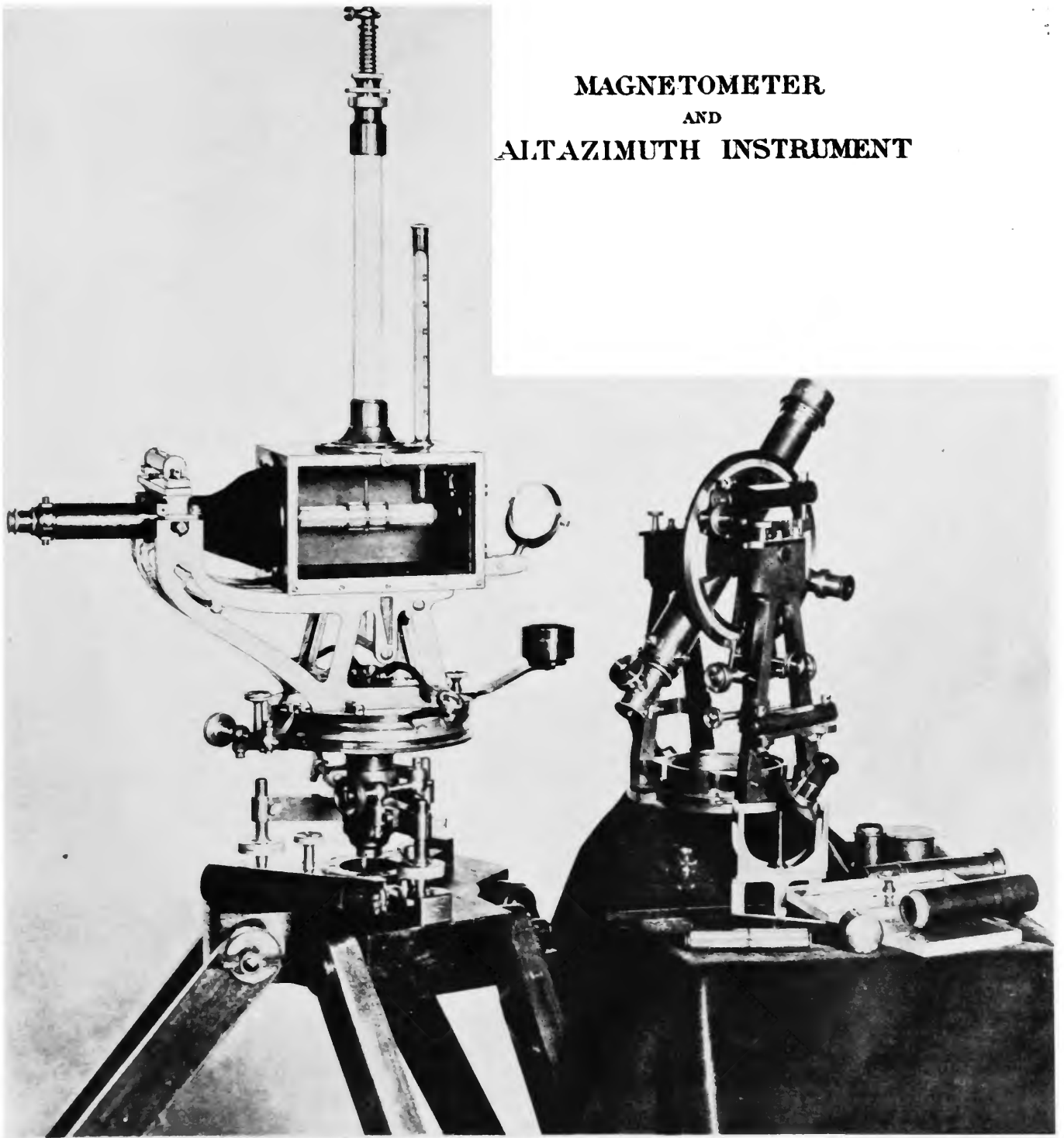

FIGURE 27.—Magnetometer and "altazimuth instrument" (theodolite) used by the Coast Survey in 1894, as illustrated in its *Report* for that year. No. 11 (Figure 39) in the present collection is an instrument of this type.

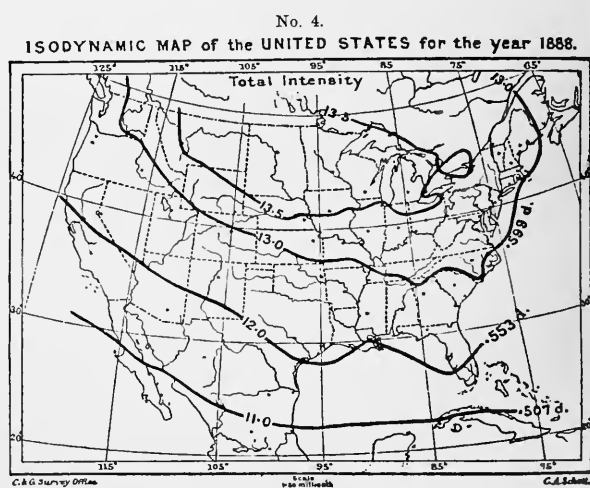
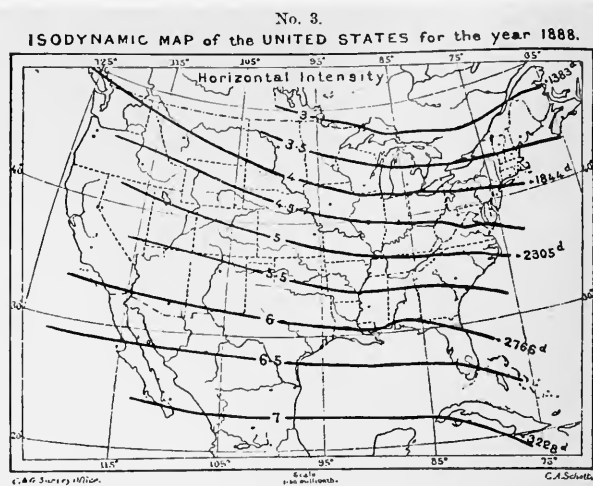
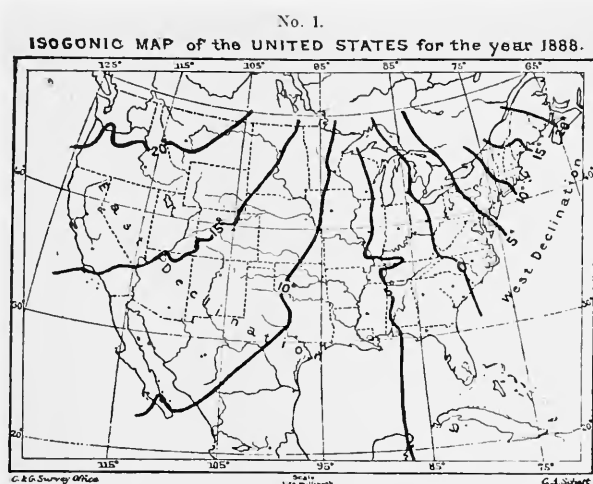

FIGURE 28.—These charts show, for the United States in 1888, (1) lines of equal declination (isogonic lines, or magnetic longitude), (2) lines of equal inclination (isoclinic lines, or magnetic latitude). Whereas the network of latitude and longitude lines is sufficient to the solution of problems of geography, the network, such as it is, of isogonic and isoclinic lines merely indicates that terrestrial magnetism is a more complex problem. Points of equal magnetic intensity can also be diagrammed, the result being (3 and 4), networks of "isodynamic" lines. (From *Short Description of Articles Forming the Coast and Geodetic Survey Exhibit at the Centennial Exposition of the Ohio Valley and Central States*, Washington, 1888.)

ter (they had to be recalibrated frequently) they were endowed with a different name, "variometer."

These observations answered some questions and raised others. In the 1880s the existence of vertical electric currents in the atmosphere was demonstrated by Adolph Schmidt of Götha and Arthur Schuster of England. In his development of Gauss's mathematical treatment of geomagnetism, Schuster was led to two further conclusions; first, that most of the earth's magnetism arises in events below the surface, partly caused by increased conductivity at greater depths; second, that diurnal and secular (i.e., daily and long term) variations are due to electromagnetic interaction between the earth and its atmosphere. In 1897 L.A. Bauer published summary conclusions of the half-

century of geomagnetic theorizing since Gauss: about 95% of the earth's magnetic field is due to causes within the crust. Another 2.5% is due to causes outside the crust. A final 2.5% cannot be described as an intrinsic magnetic field, but indicates vertical currents of atmospheric electricity.

The physical explanation of these broad conclusions was far from complete, and the fundamentals of terrestrial magnetism remained elusive. The number of other phenomena to which it was connected continued to increase. Not only was its relationship to solar phenomena found to be ever more complicated, but in 1894 E.L. Leyst claimed that geomagnetism is influenced by the planets, and two years later R. von Eotvos discovered a relationship between

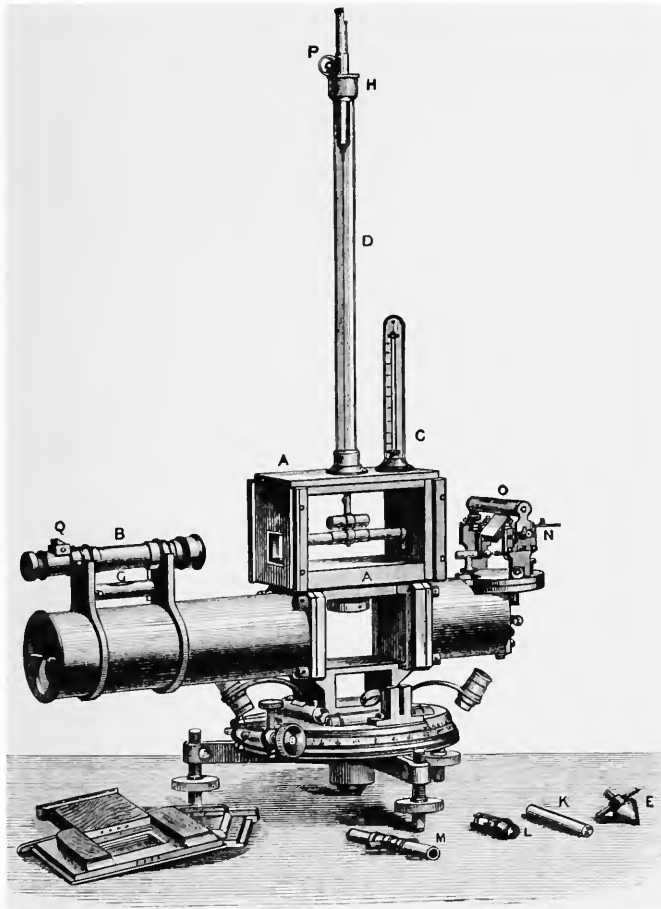
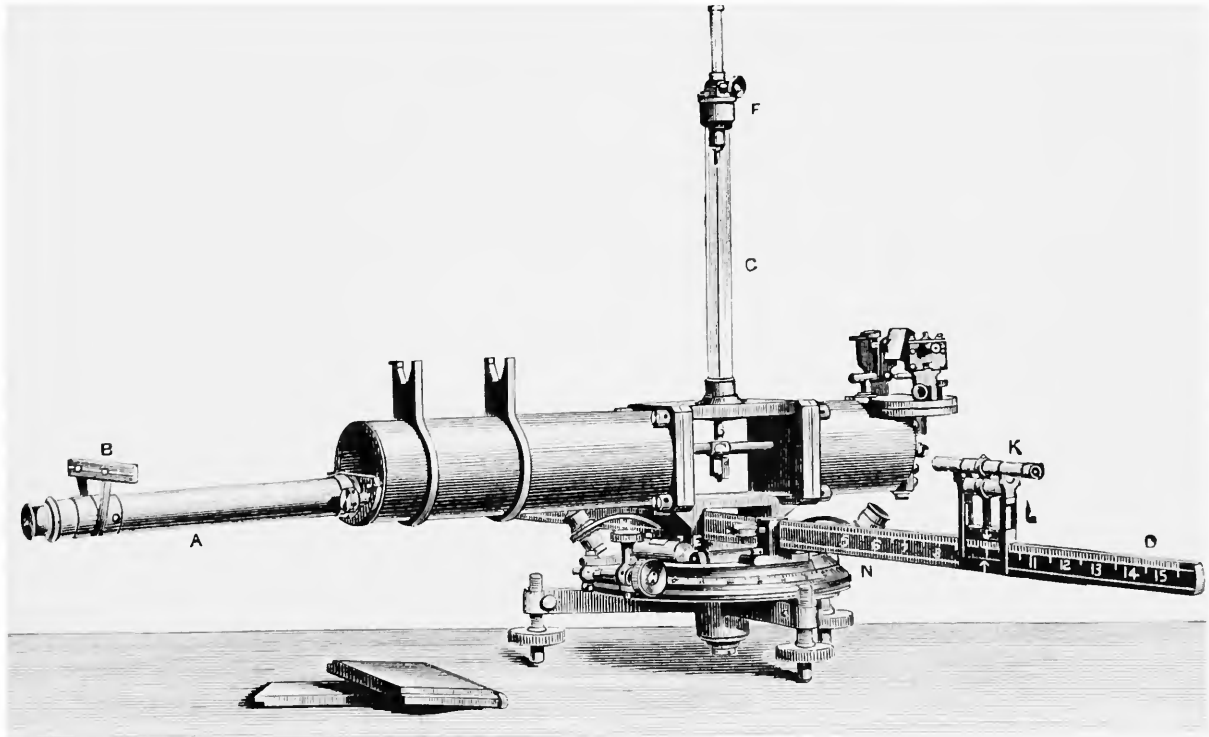

FIGURE 29.—The Kew magnetometer. This instrument, shown at the left arranged for "vibrations" (i.e., intensity measurement), and below arranged for deflection, was designed at Kew and introduced before 1880. The instrument is represented in the present collection by No. 9 (Figure 37). (From J. E. H. Gordon, *A Physical Treatise on Electricity and Magnetism*, New York, 1880.)





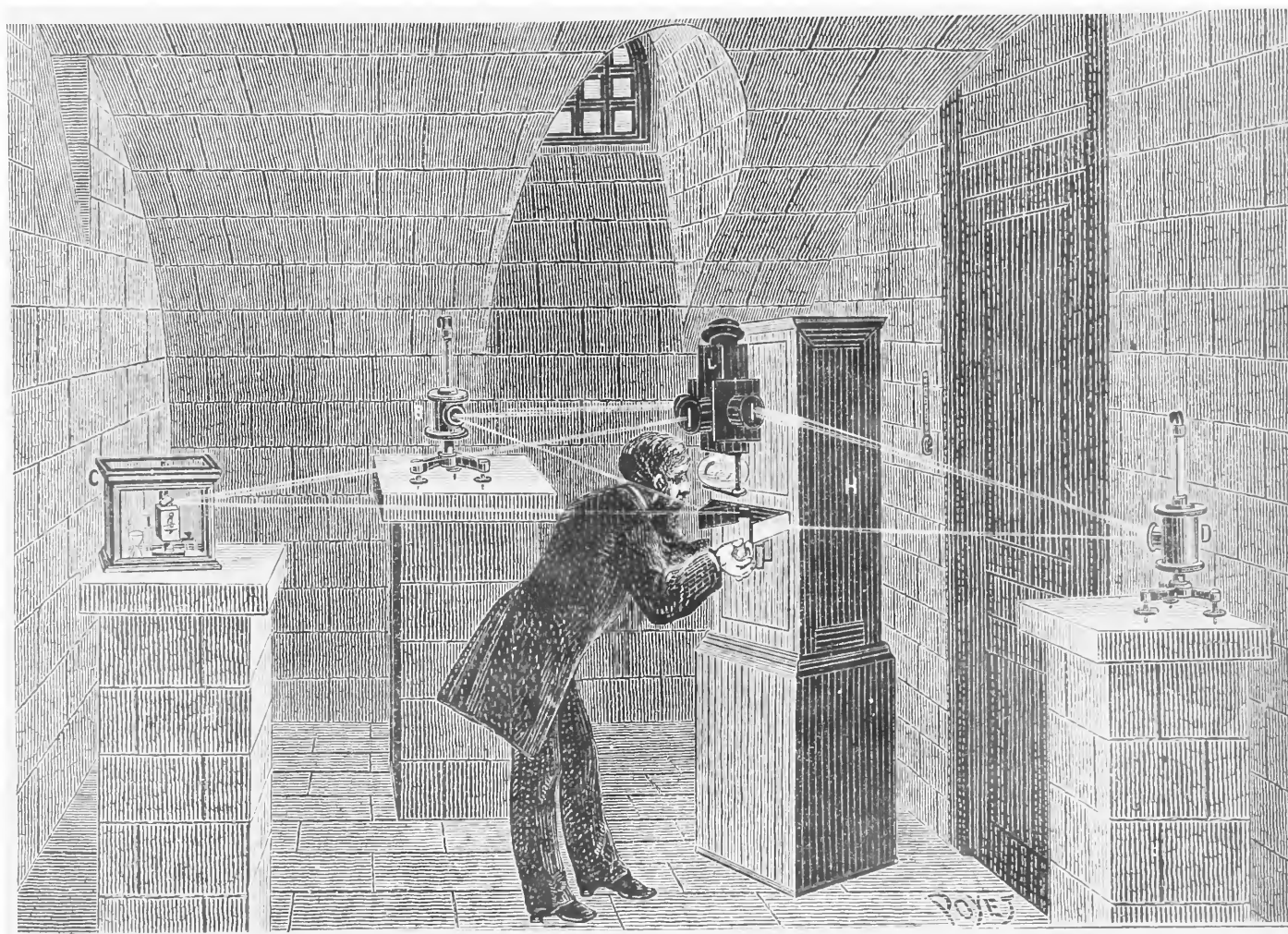

FIGURE 30.—Photographic registration at the magnetic station of Parc Saint-Maur Observatory, France, in the 1880s. (From *La Nature*, 11, 1882–1883.)

geomagnetism and gravity. “The earth seems,” wrote A. W. Rucker in 1896, “alive with magnetic forces, be they due to electric currents or to variations in the state of magnetized matter.”

A Meteorological Congress was held in Chicago in 1893, in connection with the World Columbian Exposition. This meeting included the first international discussion since 1880 of the results of recent geomagnetic studies, for which a new generation of well-trained physicists, and instruments developed as by-products of the burgeoning electrical technology, provided new approaches and points of view.

#### Early Twentieth Century Research<sup>6</sup>

In 1896 the first specialized journal, *Terrestrial Magnetism and Atmospheric Electricity*, was begun. In 1899 the Coast and Geodetic Survey created a Division of Terrestrial Magnetism, and an International Magnetic Congress convened,

to plan a new level of commitment. Most importantly, in 1904 a Department of Terrestrial Magnetism (usually abbreviated DTM) was established in the two-year-old Carnegie Institution of Washington.

The key figure in the United States was L.A. Bauer (1865–1932), a civil engineer who had been employed by the Coast Survey from 1887. Adopting geomagnetism as his major field, Bauer studied in Berlin, where he received a doctorate in 1895. He subsequently worked with the Maryland State Geological Survey and completed, between 1896 and 1899, the first American geomagnetic survey equal in the quality of its results to the British surveys. As head of the Coast Survey’s new Division of Terrestrial Magnetism, Bauer initiated a new survey of the entire country, which by its completion in 1915, had “occupied” 5500 stations (compared to about 160 stations between 1844 and 1856). Key stations were regularly reoccupied, to obtain secular variation data. Commenting on the support he had received for these projects, Bauer remarked, “never

before has such enthusiastic interest been taken in this elusive subject.”

In 1904 Bauer became the first Director of the Carnegie's DTM. Like other divisions of the Carnegie Institution, explicitly focusing on international (and hitherto neglected) subjects, the DTM began a World Magnetic Survey, with cruises of its ships, the *Galilee*, in the Pacific Ocean, 1905–1908, and *Carnegie* (a “non-magnetic” ship), 1909–1929. The *Carnegie* made seven cruises, including several circum-navigations, while the DTM at the same time dispatched land expeditions to Alaska and the Canadian Arctic, South America, Africa, and Asia.

This extraordinary activity required an accelerated program for the improvement of instruments, an effort that had already begun at the Coast Survey and was continued in the instrument shop of the DTM. Older Coast Survey instruments were tested, as were the Survey's English, French, and German instruments. The present collection includes (No. 14, Figure 43) the first DTM magnetometer, which followed the Coast Survey's standard theodolite-magnetometers of 1894 (Figure 27) in featuring octagonal collimator magnets, to facilitate inversion; a second generation reverted to cylindrical magnets, the octagonal having been found magnetically irregular. These (see No. 15, Figure 44) were designed by DTM and manufactured by Bausch, Lomb, and Saegmuller, an amalgamation (1905) of instrument-makers in Washington and in Rochester, New York.

Because of their bulk, these early DTM magnetometers were inappropriate for field work in remote areas. For this application the size was reduced and then two new “universal” magnetometers were designed. One type (Nos. 17 and 18, Figures 46 and 47) incorporated magnetometer, theodolite, and dip circle into a single unit, eliminating the need to carry two separate instruments. The second type (No. 19, Figure 48) comprised a theodolite-magnetometer, an earth inductor, and a portable sine-galvanometer. These were separate pieces, hence it was not, strictly speaking, “universal.” However, it was more significant in its replacement of the dip circle by the earth inductor.

The earth inductor, an instrument for measuring the electric effect resulting from the rotation of a coil of wire in the earth's magnetic field, had been introduced by Weber in 1837. That the electric current generated by such an instrument is proportional to the direction and intensity of the local magnetic field was obvious enough. However, the instrument (particularly its galvanometer) was inadequate for the precise measurement of this current—to the degree that it existed through most of the nineteenth century only as a demonstration device for classroom use (see Figure 72). This weakness was largely rectified by Wild and Mascart in the 1880s, by their perfection of a “null method,” that is, a method in which the galvanometer merely *indicates* the flow of current, but does not measure it. Still, the earth inductor

remained so inferior to the dip circle, for geomagnetic field work, that it was scarcely used, indeed, scarcely thought of, even after further improvement of the galvanometer had justified its reconsideration. This reconsideration at the DTM, 1910–1915, yielded an instrument that was more reliable than the dip circle.

The DTM encountered its most difficult challenge in instrument design in meeting its commitment to a world ocean survey, for the accuracy of instruments used at sea lagged far behind that of those used on land. Between 1905 and 1913 two instruments for measuring declination and horizontal intensity, and two others for inclination, were designed and installed on the *Galilee* and the *Carnegie*. Only one of these types is extant, the Lloyd-Creak dip circle (No. 37, Figure 65). As the name indicates, it was not, strictly speaking, a DTM design. The original models were built in England, according to specifications of E.T. Creak of the Admiralty Compass Division. When tested on Coast Survey vessels in 1904–1905, they failed. Bauer gave the British maker new specifications and further modified the circles later in the DTM instrument shop. The result was to bring the quality of sea dip measurements almost up to that of land measurements. Ultimately the DTM produced dip instruments that agreed within a half-minute of arc.

Bauer specified four principles of instrument design. First was “to have instruments, methods of observation, and methods of computation all form one harmonious whole . . .” This reflects his concern that the data be reduced easily and published quickly. The second was to join several functions in one instrument. An immediate reason for this was to lighten the work of the observer; a deeper reason was to provide for checking one instrument against another. Variable conditions in the field dictated, thirdly, that any device be versatile. It had to work in high and low intensities, high and low dip, and high and low declination. The last requirement was called “symmetry;” all of the magnetic elements were to be equally emphasized.

The Carnegie Institution's instrument program was designed to meet these specifications, and largely succeeded. So did its program of geomagnetic exploration. Having accomplished much of its mission, the Carnegie Institution (whose ship *Carnegie* had its geomagnetic voyages ended by an accidental fire in 1929), reduced its activities, and finally withdrew from the field in 1946. The Coast Survey similarly reduced its activity.

In part these reductions in activity were offset by the entry into the field of geomagnetic research of the well-endowed laboratories of the mineral companies. That a magnetic compass responds to the nearby presence of iron ores had been known virtually since the compass itself was known, and the cheap and handy miner's dip needle had been a familiar sight for centuries (see Figure 68). What was new in the twentieth century was an awareness that the presence of many kinds of mineral—including petroleum—

modifies the magnetic properties of the earth in its vicinity. This in turn led to the development of magnetometers that were both scientifically respectable and useful for mineral prospecting.

Adolf Schmidt, who had been a leader in magnetic studies since the 1880s and was Director of the Prussian Meteorological and Magnetic Observatory from 1927, introduced in 1915 a new instrument, a "magnetic vertical balance," which was a refinement of the venerable vertical force magnetometer of Lloyd, and which was to revolutionize mineral prospecting by magnetic methods. Schmidt's instrument was adopted for mineral exploration in the United States in the 1920s. Its improvement was taken up at the Gulf Research and Development Corp., of Pittsburgh, which made the example in the present collection (No. 22, shown herein only as a diagram, Figure 51). It is particularly sensitive to local geomagnetic anomalies, and hence has the characteristics of a variometer.

More recently the variometer itself has been adapted for use both in the geomagnetic observatory and in mineral prospecting. This is exemplified in the present collection by No. 25 (Figure 55), an instrument made by the Ruska Instrument Company of Houston, Texas. Here the variometers are "surrounded" by an artificial magnetic field created by a steady current in a Helmholtz coil around the instrument. It had long been thought that the intervention, between the magnet and the terrestrial field, of such a steady magnetic field would improve the sensitivity of the instrument, but not until the twentieth century was it possible to produce a field of the requisite constancy. Advances in electrical technology made it possible.

The advent of aircraft created the possibility of another improvement, the rapid geomagnetic survey of large areas, in search of magnetic anomalies meriting closer scrutiny. Research on the development of a suitable magnetometer, undertaken at Gulf Research and Development, led to the construction of an experimental instrument in 1940 (No. 26, Figure 57). As in the Ruska instrument just mentioned, the sensing element, devised by Victor V. Vacquier, was located within a steady artificial magnetic field, but the

principle of the instrument was different. The sensing element was free of mechanical parts, depending on the measurement of "saturation effects."

In terms of sensitivity the Gulf airborne magnetometer was said to be as superior to the Schmidt magnetometer as the latter was to the ordinary dip circle. However, the airborne device, which was towed behind the aircraft in a torpedo-shaped housing, was still influenced by the vibrations of the plane. Further experimentation was interrupted by the Second World War, which, however, gave occasion for improvement in a new direction. It was suggested that it might be capable of responding to the presence, beneath the sea, of an iron body with the bulk of a submarine. Tests were sufficiently promising to justify a program, centered at the United States Naval Ordnance Laboratory, for further development. The collection includes (No. 27, Figure 58) the second version of the result, dated about 1953. Called MAD (Magnetic Airborne Detector), it is a complex of electronic components, entirely located within the aircraft, that continuously record the total intensity of the field and the magnitudes of directional angles.

By the time of the International Geophysical Year of 1957–1958, airborne magnetometers had been joined by satellite magnetometers. Formally, American geomagnetic research is now divided between the United States Geological Survey and the National Ocean Survey (of which the old Coast Survey is a unit). The subject has broadened greatly both in terms of the questions asked and in the methods used. The grand and heroic era of geomagnetic expeditions may be over, but the subject, if less romantic, has achieved a higher level of respectability. The search for minerals by geomagnetic means is even more urgently pursued—and more scientifically. Popular interest in the theory of continental drift has given the science of geomagnetism unprecedented "visibility," in the search for the magnetic orientations of undersea geological formations, such as the successive strata either side of the mid-Atlantic ridge, a study called paleomagnetism. In short, scientists still seek, on a larger canvas, the mechanism that produces the earth's magnetism.

# Catalog of Geomagnetic Instruments

Collection no.	Figure no.	Type	Identification	Date	Source; NMAH catalog no.
1	31	Declinometer	Gambey type	ca. 1830	Purchase 82.688.1
2	32	Variation transit	Gambey-Bache; mkd. Gambey a Paris	ca. 1840	Carnegie Inst. 316592
3	33	Magnetometer	type of Lamont	19th cent.	Univ. of Virginia 323355
4	34	Unifilar magnetometer	mkd. Griffin & George, London	1962	Purchase 321545
5	—	Unifilar magnetometer	unmarked	mid-19th cent.	Univ. of Virginia 336624
			This instrument is similar to that illustrated in the Deluil catalog of 1863 (see Figure 13, no. 510). The telescope is missing.		
6	35	Magnetometer	Grunow; unmarked	ca. 1870	U.S. Military Academy 316428
7	—	Unifilar magnetometer	mkd. Otto Fennel	ca. 1875	USC&GS 316512
			The Fennel magnetometers, primarily intended for use in mines, were more durable and portable than research instruments. This small (14½ inch high) instrument has a massive copper damping plate surrounding the magnet to facilitate quick reading. The instrument is incomplete.		
8	36	Magnetograph	Adie	ca. 1880	USC&GS 316525
9	37	Magnetometer	Kew type; mkd. Dover 145	1880	USC&GS 316506
10	38, 64	Magnetometer	French survey type; mkd. Chasselon a Paris 42; CS 21	ca. 1884	USC&GS 316507
11	39	Magnetometer	Coast Survey; mkd. CS 18	1892–1893	USC&GS 82.671.8
12	41	Magnetometer	Eschenhagen-Tesdorpf; mkd. CS 25	ca. 1900	USC&GS 316505
13	42	Magnetometer	Wild-Edelmann; mkd. CS 22	1902	USC&GS 316518
14	43	Magnetometer	CIW 1	ca. 1902	Carnegie Inst. 83.39.04
15	44	Magnetometer	CIW 4	ca. 1905	Carnegie Inst. 316516
16	45	Magnetometer	CIW 8	1906	U.S.G.S. 82.671.11
17	46	Universal magnetometer	CIW 19	1911	U.S.G.S. 82.671.3
18	47	Universal magnetometer	CIW 21	1911	USC&GS 316504
19	48	Magnetometer and earth inductor	CIW 26	ca. 1913	USC&GS 320627

Collection no.	Figure no.	Type	Identification	Date	Source; NMAH catalog no.
20	—	Magnetometer and earth inductor	CIW 28	ca. 1916	U.S.G.S. 82.671.7
			This apparatus, technically similar to No. 19, Figure 48, was used by CIW in South America in 1917–1919.		
21	50	Magnetometer	British India survey pattern; mkd. CS 40	ca. 1927	U.S.G.S. 82.671.2
22	51	Magnetometer	Schmidt; mkd. Gulf Research & Development Co, Pittsburgh, Pa.	20th cent.	Gulf Research & Development MHIP8745
23	52	Variometers	Edelmann; mkd. Dr. T. Edelmann, München	ca. 1890	USC&GS 83.39.5&6
24	53	Variometers	Eschenhagen-Töpfer; mkd. Otto Toepfer Potsdam	ca. 1900	U.S.G.S. 82.671.12
25	55	Variometers	Ruska; mkd. Ruska Instrument Corp., Houston, Texas	ca. 1950	U.S.G.S. 82.671.13
26	57	Airborne magnetometer	Gulf; mkd. made by Gulf Research & Development Co., Pittsburgh, Pa.	ca. 1940	Gulf Research & Development MHIP8745
27	58	Airborne magnetometer	mkd. U.S. Naval Hydrographic Office. VAM	ca. 1953	U.S. Naval Oceanographic Office, Bay St. Louis, Mich. 81.607.1-13
INCLINOMETERS (dip circles)					
28	59	Demonstration	U. Vt.; unmarked	early 19th cent.	Univ. of Vermont 326995
29	—	Geodetic	Froment; mkd. Froment a Paris	ca. 1860	U.S. Naval Observatory 327705
			In size and general appearance the instrument resembles No. 30 (Figure 61). The 10-in/25.4-cm circle is graduated to ten minutes of arc, but without reading lenses. The needle is missing. P.G. Froment lived from 1815 to 1865.		
30	60	Geodetic	Barrow; mkd. CS 9	ca. 1860	USC&GS 307207
31	61	Geodetic	Wurdemann; mkd. CS 10	ca. 1860	USC&GS 314633
32	—	Geodetic	U.S. Naval Observatory	1874	U.S. Naval Observatory 327714
			A simple instrument with a 6-in/15-cm needle and a scale marked to read only in minutes. Nonetheless a note attached identifies it as the product of a special congressional appropriation on the occasion of the transit of Venus of 8 December 1874, and it was exhibited at the Philadelphia International Exposition on 1876.		
33	63	Geodetic	Kew type; mkd. CS 23	ca. 1880	U.S. Naval Observatory 314632

Collection no.	Figure no.	Type	Identification	Date	Source; NMAH catalog no.
34	62	Geodetic	Kew type; mkd. Dover 85	ca. 1880	U.S. Naval Observatory 327706
35	61, 64	Geodetic	French survey type; mkd. Chasselon a Paris No. 40. CS 24	ca. 1884	USC&GS 316508
36	63	Geodetic	Kew type; mkd. Dover 158	ca. 1918	Carnegie Inst. 83.39.2
37	65	Geodetic	Lloyd-Creak; mkd. Dover 168	ca. 1900	U.S.G.S. 316509
38	60	Geodetic	Lloyd-Creak; mkd. Dover 169	ca. 1900	U.S.G.S. 83.39.3
39	—	Geodetic	Kew type; mkd. Dover 174	ca. 1900	U.S.G.S. 82.671.4
40	63	Geodetic	Kew type; mkd. Dover 240	ca. 1890	Carnegie Inst. 83.39.1
41	67	Prospecting	Hotchkiss; "Superdip"	1929	W. Hotchkiss 81.0488
42	68	Prospecting	mkd. W & LE Gurley	ca. 1890	Purchase 335530
43	68	Prospecting	mkd. Dietzgen	ca. 1900	S.H. Oliver 314642
44	68	Prospecting	mkd. Keuffel & Essor	20th cent.	Batchelor Foundation 319047
45	69	Prospecting	unmarked	ca. 1912	MHIP8740
46	69	Demonstration	mkd. Queen, Philadelphia		U.S. Dept. of Interior 261270
EARTH INDUCTORS					
47	70	Marine	CIW 3	1912	U.S.G.S. 82.671.5
48	71	Observatory	mkd. CS 8	ca. 1950	U.S.G.S. 82.671.1
49	72	Demonstration	mkd. Jas. W. Queen, maker, Phila. 10.75-in/27-cm coil	20th cent.	Franklin College 337246
50	72	Demonstration	mkd. Max Kohl, Chemnitz. Central Scientific Co., Chicago 11.8-in/30-cm coil	20th cent.	Trinity College 81.743.4
51	72	Demonstration	unmarked 6.25-in/16-cm coil	mid-19th cent.	Princeton Univ. 318589
52	—	Demonstration	Hawkins & Wale 18-in/46-cm coil	1870s	U.S. Military Academy 322994
53	—	Demonstration	unmarked coil diam. 9.5-in/14-cm	early 20th cent.	Wabash College 322994



Collection no.	Figure no.	Type	Identification	Date	Source; NMAH catalog no.
MISCELLANEOUS					
54	73	Induction apparatus	Lamont type; mkd. CS I	20th cent.	U.S.G.S. 82.671.10
55	74	Induction apparatus	Nelson; mkd CS M	20th cent.	U.S.G.S. 82.671.9
56	75	Terrestrial magnetic plot (model)	Bache; See Figure 5 for marking	1862	unk. 314745

## Notes

<sup>1</sup> A.C. Mitchell's astonishingly detailed "Chapters in the History of Terrestrial Magnetism," which ends with the year 1500, is in sharp contrast to the sparse historical literature on the subject in subsequent times, where we are limited to such sketchy treatment of the 17th and 18th centuries as found in Mottelay's *Bibliography* and the "Historical notes" to the *Geomagnetism* of Sydney Chapman and Julius Bartels. Buffon's *Traité de l'aimant* of the 1780s is perhaps the first "modern" book on the subject. (Full citation of these works will be found in the bibliography.)

<sup>2</sup> Although limited in its objective, Anita McConnell's book on early instruments seems to be the only predecessor to our catalog. The instruments used at the Royal Society were described by Cavendish and Gilpin. Arago's extended article on "Magnetism terrestre" gives an interesting picture of early instruments and observations in France. The publications of Gauss, Weber, and Lamont (see also Guggsworth) deal with early instruments developed in Germany. (See full citations in the bibliography.)

<sup>3</sup> Kellner's article on the much-studied Alexander von Humboldt relates specifically to our topic. Geomagnetism was one of the favorite interests of the prolific Humboldt, whose own writings can be taken as the starting point for the systematic study of geomagnetism. British activity was depicted principally in the reports of the BAAS, from Christie, Whewell, and especially from Sabine, who succeeded Humboldt as the principle promoter of the subject, and in the reports of appropriate committees of the Royal Society. It culminated in the *Magnetical Instructions* of Riddell. John Herschel in turn succeeded Sabine as authority. German work was reported by Gauss and Weber, especially in the reports of the "Magnetische Verein." (See full citations in the bibliography.)

<sup>4</sup> Fleming has written on early geomagnetic work in the United States. Alexander Dallas Bache played a role in the United States similar to that of Humboldt and Sabine in Europe, and Locke, Loomis, and Lovering periodically reported on observations. Benjamin Silliman, who regularly reported on "recent progress," in his *American Journal of Science*, treated geomagnetism in 1846. (Systematic work was done earlier in Canada, thanks to the British program for "colonial observatories," associated particularly with Lefroy.) Sabine reported in 1846 on the progress of a geomagnetic survey of North America. Ennis has described the magnetic work of the Wilkes Expedition of 1838–1842, and Gillis has written on the work of the Naval Astronomical Expedition of 1849–1852, which he headed. Geomagnetic work in North America is frequently touched on in the *Papers* of Joseph Henry, and in the *Annual Reports* of the Smithsonian Institution, which he headed. The Smithsonian's short-lived geomagnetic observatory was described by Hilgard. (See full citations in the bibliography.)

<sup>5</sup> L.A. Bauer and C.A. Schott were the chief reporters on, as well as the chief scientists in, geomagnetic work at the U.S. Coast and Geodetic Survey in the later 19th century. The history of the "International Polar Year" (1881–1882) was related in the *Annals* (1959) of the International Geophysical Year. (See full citations in the bibliography.)

<sup>6</sup> The epochal work of the Carnegie Institution during the early years of the century was reported in its *Researches*, published during the years 1912–1917. See also Hazard's report of 1925 and McComb's of 1941. (See full citations in the bibliography.)

# Bibliography

(See also references cited in the illustration legends.)

- Anonymous. "Account of the Magnetical Instruments Employed and of the Mode of Observation to be Adopted in the Magnetical Observatories about to be Established by Her Majesty's Government." *Annals of Electricity*, 4 (1840):451–474.
- . "Magnetical Observations," *Report, BAAS*, 7 (1839), pages xi ff. [Continued (under other titles), 8 (1840), pages 31ff, 10 (1841), pages 427ff.]
- Airy, G.B. *Magnetical and Meteorological Observations Made at the Royal Observatory, Greenwich* (1847). London, 1849.
- Arago, D. F. J. "Magnetisme terrestre." In Arago, *Oeuvres*, Volume 4 (1854), pages 459–544. Paris.
- . "Eloge" (to Gambey). In Arago, *Oeuvres*, Volume 3 (1855) [sic], pages 601–608. Paris.
- Bache, A.D. "On the Diurnal Variation of the Horizontal Needle" (1832). *Transactions, APS*, new series, volume 5 (1837), pages 1–22.
- . "Observations of the Magnetic Intensity at 21 Stations in Europe." [1836–1838]. *Transactions, APS*, new series, volume 7 (1841), pages 75–100.
- . *Observations at the Magnetic and Meteorological Observatory at the Girard College, Philadelphia*. 3 volumes. Washington, 1847.
- . "Discussion of the Magnetic and Meteorological Observations Made at the Girard College Observatory (1840–45). Part 2." *Smithsonian Contributions to Knowledge*, 13. Washington, 1863.
- . "Description of Magnetic and Meteorological Observations at Girard College, 1841–45. *Smithsonian Contributions to Knowledge*, 14 (section 3). Washington, 1865.
- Bache, A.D., and E.H. Courtenay. "Observations to Determine the Magnetic Dip at Baltimore, Philadelphia, New York, West Point, Providence, Springfield, and Albany." *Transactions, APS*, new series, volume 5 (1834), pages 209–215.
- . "On the Relative Horizontal Intensities of Terrestrial Magnetism," *Transactions, APS*, new series, volume 5 (1837), pages 427–455.
- Bache, A.D., and J.E. Hilgard. "On the General Distribution of Terrestrial Magnetism in the United States." *AJS*, new series, 24 (1857), pages 1–20.
- Barlow, Peter. "Observations and Experiments on the Daily Variation of the Horizontal and Dipping Needles." *PT*, 113 (1823), pages 326–341.
- Bauer, L.A. "The Magnetic Work of the United States Coast and Geodetic Survey." *TM*, 4 (1899), pages 93–104.
- . *United States Magnetic Declination Tables and Isogonic Charts, and Principal Facts Relating to the Earth's Magnetism*. Washington, 1902.
- . "Regarding Improvement of Appliances for Measurement of the Earth's Magnetic Elements by Electric and Magnetic Methods." *TM*, 19 (1914), pages 1–18.
- . "The Work Done by the United States Coast and Geodetic Survey in the Field of Terrestrial Magnetism." In *USC&GS, Centennial Celebration*. Washington, 1916.
- Bauer, L.A., and J.A. Fleming. "The Magnetic Observatories of the U.S. Coast and Geodetic Survey in Operation on July 1, 1902." *USC&GS, Report for 1902*, pages 303–331.
- Brooke, Charles. "On the Automatic Registration of Magnetometers, and Other Meteorological Instruments, by Photography." *PT*, 137 (1847), pages 59–77.
- . "On the Automatic Registration of Magnetometers." *PT*, 142 (1852), pages 19–24.
- Buffon, Count. *Traité de l'aimant*. New edition. Dordrecht, 1799. [1st edition 1783–1788]
- Carnegie Institution of Washington. *Researches of the Department of Terrestrial Magnetism*. 6 parts. Washington, 1912–1917. [These are referred to separately in the illustration legends.]
- Cassini, J.D. "Observations de la déclinaison et des variations de l'aiguille aimantée." *Journal de Physique*, 11 (1792), pages 298–303, 340–352.
- . "Description d'une nouvelle boussole propre à déterminer avec la plus grande précision la direction et la déclinaison absolu de l'aiguille aimantée." *Mémoires de l'Institut National des Sciences et Arts* (Paris), 5 (an. xii [1804]), pages 145–54.
- Cavallo, Tiberius. *A Treatise on Magnetism*. 3rd edition. London, 1800.
- Cavendish, Henry. "An Account of the Meteorological Instruments Used at the Royal Society's House." *PT*, 66 (1776), pages 375–401.
- Celsius, Anders. "Anmerkungen über die stündlichen Veränderung der Magnetnadel." *AdS*, 2 (1740), pages 45–48.
- Chapman, Sydney, and Julius Bartels. *Geomagnetism*. 2 volumes. Oxford, 1940. [See especially volume 2, pages 898–937, "Historical Notes."]
- Chree, Charles. "Magnetic Work at the Kew Observatory, Richmond, Surrey." *TM*, 1 (1896), pages 13–26.
- Christie, S. H. "On Improvements in the Instruments and Methods Employed in Determining the Direction and Intensity of the Terrestrial Magnetic Force." *PT*, 123 (1833), pages 343–358.
- . "Report on the State of Our Knowledge Respecting the Magnetism of the Earth." *Report, BAAS*, 3 (1834), pages 105–130.
- Courtenay, E.H. "Observations to Determine the Magnetic Dip at Baltimore . . ." (1833–37). *Transactions, APS*, new series, 5 (1837), pages 209–215.
- Davis, C.H. "Electric Car Disturbances at the Magnetic Observatory of the United States Naval Observatory." *TM*, 1 (1897), pages 125–127.
- Duperrey, Captain. "Du magnétisme terrestre." *Annales Maritimes et Coloniales*. [No further identification. A copy is in A. D. Bache, *Miscellaneous Pages and Manuscripts*, in the library of the Smithsonian Institution.]
- Edelmann, M.T. "On the Construction of Earth-Magnetic Instruments." *United States Weather Bureau Bulletin*, no 11 (1893), pages 522–539.
- Ennis, C.C. "Magnetic Results of the United States Exploring Expedition (Wilkes Expedition, 1838–42)." *TM*, 39 (2) (1934), pages 91–101.
- Eschenhagen, M. "On Some Improvements in Magnetic Instruments." *United States Weather Bureau Bulletin*, 11 (1893), pages 539ff.
- Euler, J.A. "Theorie de l'inclinaison." *Histoire de l'Académie Royale des Sciences et des Belles Lettres de Berlin*, 1755: pages 117–201.
- Euler, Leonard. "Recherches sur la déclinaison de l'aiguille aimantée." *Histoire de l'Académie Royale des Sciences et de Belles Lettres de Berlin*, 1757: pages 175–251. [Disproves Halley's hypothesis of four magnetic poles.]
- Fleming, J.A. "Geomagnetism: World-wide and Cosmic Aspects with Especial Reference to Early Research in America." *Proceedings, APS*, 84 (1932), pages 263 ff.
- Forbes, J.D. "Account of Some Experiments Made in Different Parts of Europe on Terrestrial Magnetic Intensity." *Transactions of the Royal Society of Edinburgh*, 14 (1836–1840), pages 1–29.
- Gauss, C.F. "Observations of the Magnetic Inclination at Göttingen, (1841)." In *Taylor's Scientific Memoirs*, volume 3 (1843), pages 623–665. London.
- Gauss, C.F., and Wilhelm Weber. "Remarks on the Construction of Magnetic Observatories and the Instruments Which They Should Contain."

- Annals of Electricity*, 3 (1839), pages 92–108. [Translated from the German edition of 1833. Illustrated.]
- \_\_\_\_\_. [Five reports on their work at the Göttingen magnetic observatory are printed, in English translation.] In *Taylor's Scientific Memoirs*, volume 2 (1841). London. [See also Guggsworth, below.]
- \_\_\_\_\_. "A General Outline of the Various Theories Which Have Been Advanced for the Explanation of Terrestrial Magnetism." *Annals of Electricity*, 1 (1837), pages 117–123.
- Gilliss, J.M. *A Report of the Plan and Construction of the Depot of Charts and Instruments . . .* Washington, 1845 [Report of the Secretary of the Navy. Senate, 28th Congress, 2nd Session.]
- \_\_\_\_\_. United States Naval Astronomical Expedition to the Southern Hemisphere during the Years 1849–52. In *Magnetic and Meteorological Observations*, volume 6. Washington, 1856.
- Gilpin, George. "Observations on the Variation and Dip of the Magnetic Needle, 1786–1805" [at the Royal Society]. *PT*, 96 (1806), pages 385–419.
- Graham, George. "An Account of Observations Made of the Variation of the Horizontal Needle at London . . . 1722–23." *PT*, 33 (1724), pages 96–107.
- Graham, J.D. "Observations of the Magnetic Dip Made at Several Positions . . . and of the Magnetic Declination in the United States" (1840). *Transaction, APS*, new series, 9 (1846), pages 329–380.
- Guggsworth, Julian. "Remarks on the Construction of Magnetic Observatories and the Instruments Which They Should Contain. From the German of Professors Gauss and Weber." *Annals of Electricity*, 3 (1839) pages 92–109.
- Halley, Edmund. "A Theory of the Variation of the Magnetical Compass," and "An Account of the Cause of the Changes of the Variation of the Magnetical Needle." In *Miscellanea Curiosa*, volume 2 (1723–1727), pages 27–42 and 43–60. London.
- Hansteen, Christian. *Untersuchungen von den Magnetismus der Erde*. Christiania [Oslo], 1819.
- \_\_\_\_\_. "Beobachtungen über die Intensität des Magnetismus im nördlichen Europa." *Annalen der Physik*, 3 (1825), pages 225–234.
- Harvard University. Fogg Art Museum. *Early Science at Harvard*. Cambridge, Mass., 1969. [An exhibition catalog.]
- Hazard, D. J. "Terrestrial Magnetism in the Twentieth Century." *Journal of the Washington Academy of Sciences*, 15 (1925), pages 111–125.
- Heathcote, N.H. deV., and A. Armitage. *Annals of the International Geophysical Year, 1: The Histories of the International Polar Years and the Inception and Development of the International Geophysical Year*. Washington, 1959.
- Heck, N.H. "The Magnetic Survey of the United States." *Proceedings, APS*, 84 (1941), pages 205–224.
- Herschel, John. "Terrestrial Magnetism." In Herschel, *Essays from the Edinburgh and Quarterly Review*, 1857, pages 63–141. London.
- Herschel, John, editor. *Admiralty Manual of Scientific Inquiry*. London, ca. 1840. [Sabine discusses geomagnetism in section 2.]
- Hilgard, J.E. "Description of the Magnetic Observatory at the Smithsonian Institution." *Smithsonian Institution Annual Report for 1859*, pages 385–395.
- Hoogewerff, J.A. "Magnetic Observation at the United States Naval Observatory, 1888 and 1889." In *Washington Observations*, Appendix 1. Washington, 1890.
- Humboldt, Alexander von. "Ueber die Mittel, die Ergründung einiger Phänomene des tellurischen Magnetismus zu erleichtern." *Annalen der Physik und Chemie*, 15 (1829), pages 319–336.
- \_\_\_\_\_. "Beobachtungen der Intensität magnetischer Kräfte und der magnetischen Neigung, angestellt in den Jahren 1798 bis 1803, von 48°50' NB bis 12° SB und 3°2' OL bis 106°22' WL, in Frankreich, Spanien, den canarischen Inseln, dem Atlantischen Ozean, America und der Sudsee." *Annalen der Physik und Chemie*, 15 (1829), pages 336–362.
- Kellner, L. "Alexander von Humboldt and the Organization of International Collaboration in Geophysical Research." *Contemporary Physics*, 2 (1959), pages 35–48.
- Kreil, Karl. [Letter to A. T. Kupffer.] *Philosophical Magazine*, series 3, 14 (1840), pages 241–250. [On instruments and observations at Milan (Kreil) and St. Petersburg (Kupffer).]
- Lamont, Johann von. "An Account of the Magnetic Observatory and Instruments at Munich." In *Taylor's Scientific Memoirs*, volume 3 (1843), pages 499–526. London.
- \_\_\_\_\_. *Handbuch der Erdmagnetismus*. Berlin, 1849.
- Lefroy, J.H. *Diary of a Magnetic Survey of a Portion of the Dominion of Canada (1842–44)*. London, 1883.
- \_\_\_\_\_. "On the Application of Photography to the Self-registration of Magnetic and Meteorological Instruments." *AJS*, series 2, 9 (1850), pages 319–324.
- Lefroy, Lady, editor. *Autobiography of General Sir John Henry Lefroy*. London, n.d. [1895]. [For private circulation. There is a copy in the library of the University of Toronto.]
- Lloyd, Humphrey. "Further Development of a Method of Observing the Dip and the Magnetic Intensity at the Same Time with the Same Instrument." *Transactions of the Royal Irish Academy*, 17 (1837), pages 449–460.
- \_\_\_\_\_. "An Attempt to Facilitate Measurement of Terrestrial Magnetism." *Transactions of the Royal Irish Academy*, 17 (2) (1837), page 159.
- \_\_\_\_\_. "On a Declination Instrument, Made for the Magnetical Observatory of Dublin." *Annals of Electricity*, 3 (1839), pages 75–77.
- \_\_\_\_\_. "On a New Magnetical Instrument for the Measurement of the Inclination and Its Changes." *Proceedings of the Royal Irish Academy*, 2 (1840–1844), pages 115–117.
- \_\_\_\_\_. "On the Determination of the Intensity of the Earth's Magnetic Force in Absolute Measure." *Transactions of the Royal Irish Academy*, 21 (1846), pages 3–11.
- Lloyd, Humphrey, Edward Sabine, and J.C. Ross. "Observations on the Direction and Intensity of the Terrestrial Magnetic Force in Ireland." *BAAS, Report for 1835*.
- Locke, John. "On the Magnetic Dip . . . Ohio (1837–38)." *Transactions, APS*, new series, 6 (1839), page 267–273.
- \_\_\_\_\_. "On Terrestrial Magnetism." *AJS*, 40 (1841), pages 149–156. [Concerns his work in the Ohio Valley.]
- \_\_\_\_\_. "Observations to Determine the Horizontal Magnetic Intensity and Dip at Lexington, Ky. and Cincinnati." *Transactions, APS*, new series, 7 (1841), pages 261–264.
- \_\_\_\_\_. "Observations Made in the Years 1838, '40, '41, '42, and '43 to Determine the Magnetical Dip and the Intensity of Magnetical Force, in Several parts of the United States." *Transactions, APS*, new series, 9 (1846), pages 283–328.
- Loomis, Elias. "Observations on the Variation of the Magnetic Needle, Made at Yale College in 1834 and 1835." *AJS*, 30 (1836), pages 221–233.
- \_\_\_\_\_. "On the Variation and Dip of the Magnetic Needle in different Parts of the United States." *AJS*, 34 (1838), pages 290–307.
- \_\_\_\_\_. "On the Magnetic Dip in the United States." *AJS*, 40 (1841), pages 85–92.
- \_\_\_\_\_. "Observations to Determine the Magnetic Dip . . . Ohio and Michigan." *Transactions, APS*, new series, 7 (1841), pages 1–6.
- \_\_\_\_\_. "Observations to Determine the magnetic Intensity . . ." *Transactions, APS*, new series, 8 (1843), pages 61–72.
- \_\_\_\_\_. "Notice of Some Recent Additions to Our Knowledge of the Magnetism of the United States and Its Vicinity." *AJS*, 2nd series, 4 (1847), pages 192–198.
- Lovering, Joseph. "An Account of the Magnetic Observations Made at the Observatory of Harvard University, Cambridge." *Memoir of the American Academy of Arts and Sciences*, new series, 2 (1846), pages 85–160.
- Lovering, Joseph, and W.C. Bond. "An Account of the Magnetic Observations Made at the Observatory of Harvard University." *Memoirs of the American Academy of Arts and Sciences*, new series, 2 (1846), pages 1–84.
- McComb, H. E. "Geomagnetic Observatories and Instruments." *Proceedings, APS*, 84 (1941), pages 239–255.
- \_\_\_\_\_. *Magnetic Observatory Manual*. Washington, 1952 (USC&GS Special Publication 283).

- McConnell, Anita. *Geomagnetic Instruments before 1900*. London: Harriet Wynter, 1980.
- Mitchell, A. C. "Chapters in the History of Terrestrial Magnetism." *TM*, 37 (1932), pages 105–146, 42 (1937), pages 241–280, 44 (1939), pages 77–80. [A meticulous history up to about 1500.]
- Mottelay, A.C. *Bibliographical History of Electricity and Magnetism*. London, 1922.
- Quetelet, L.A.J. *Sur l'état du magnétisme terrestre a Bruxelles . . .* Brussels, 1839.
- [Quetelet, L.A.J.] "Sur le magnétisme terrestre en Italie" [1841]. In A.D. Bache, *Miscellaneous Papers and Manuscripts*, volume 6 [in Smithsonian Institution Library, reprint from the *Mémoires* of the Academy of Sciences, Brussels].
- Reichelderfer, F.W. "The Contributions of [Charles] Wilkes to Terrestrial Magnetism, Gravity and Meteorology." *Proceedings, APS*, 82 (1940), pages 583–600.
- Reingold, Nathan, editor. *Joseph Henry Papers*. Volume 1 (1797–1832), Washington, 1972; volume 2 (1832–1835), Washington, 1975. [Contain numerous references to geomagnetism.]
- Riddell, C.J.B. *Magnetical Instructions*. London, 1844.
- Ronalds, Francis. "On Photographic Self-registering Meteorological and Magnetical Instruments." *PT*, 137 (1847), pages 111–117.
- Ross, J.C. "On the Position of the North Magnetic Pole" (1833). In A. D. Bache, *Miscellaneous Papers and Manuscripts*, volume 6 [in the Smithsonian Institution Library].
- Royal Society of London. *Report of the Committee of Physics, including Meteorology, on the Objects of Scientific Inquiry in These Subjects*. London, 1840. [Begins (pp. 1–37) with the Society's formal discussion of the methods and instruments to be used at the Colonial Observatories.]
- Royal Society of London, Committee of Physics and Meteorology. *Revised Instructions for the Use of the Magnetic and Meteorological Observatories and for the Magnetic Surveys*. London, 1842.
- Rumbaugh, L. H., and L. R. Alldredge. "Airborne Equipment for Geomagnetic Measurements." *Transactions of the American Geophysical Union*, 20 (1949), pages 836–848.
- Sabine, Edward. "Observations on the Direction and Intensity of the Terrestrial Magnetic Force in Scotland" (1836). In A.D. Bache, *Miscellaneous Papers and Manuscripts*, volume 18 [in the Smithsonian Institution Library].
- . "Report on the Variations of the Magnetic Intensity Observed at Different Points of the Earth's Surface." *Report, BAAS*, 7 (1838), pages 1–42.
- . "A Memoir on the Magnetic Isoclinal and Isodynamic Lines in the British Islands," *Report, BAAS*, 7 (1838), pages 49–195.
- . [Letter to John Herschel.] In A.D. Bache, *Miscellaneous Papers and Manuscripts*, volume 18 [in the Smithsonian Institution Library]. [Recommendations concerning the observatory to be established at Toronto.]
- . "Magnetic Observations" (n.d., ca. 1840). In A.D. Bache, *Miscellaneous Papers and Manuscripts*, volume 18 [in the Smithsonian Institution Library]. [On instruments used by Captain Fitzroy (of the *Beagle*) and others.]
- . "A Magnetic Survey of a Considerable Portion of the North American Continent," *PT*, 136 (1846), pages 237–336.
- . "On the Means Adopted in the British Colonial Magnetic Observatories for Determining the Absolute Values, Secular Change, and Annual Variation of the Magnetic Force," *PT*, 140 (1850), pages 201–219.
- . *Manual of Terrestrial Magnetism*. London, 1859.
- . *Contributions to Terrestrial Magnetism, 1840–78*. n.p., n.d. [Articles published in *PT* between these dates are here collected in two volumes (Library of Congress).]
- Saussure, Benedict de. *Voyage dans les Alps*. 4 volumes. Neuchatel, 1779–1796. [Describes his "pendulum" magnetometer (volume 1, pages 375–381).]
- Schott, C.A. "Instructions for Magnetical Observations." *USC&GS Report for 1872*, Appendix 16.
- . "Directions for Magnetic Observations with Portable Instruments." *USC&GS Report for 1881*, Appendix 8.
- . "Magnetic Survey of North America," *United States Weather Bureau, Bulletin*, 11, 1893, pages 460–468.
- [Silliman, Benjamin]. "Recent Progress of Magnetical and Meteorological Science." *AJS*, series 2, 1 (1846), pages 137–145.
- Smithsonian Institution. *Annual Report, for the years 1850–1865*. [Smithsonian geomagnetic activities are described in the narrative portion of nearly every volume during these years.]
- United States Coast and Geodetic Survey. *Magnetic Observatory Results*. [Volumes in this series were produced periodically for each observatory (Cheltenham, Tucson, Baldwin (Kansas), Honolulu, etc.)]
- Whewell, William. "Report on the Recent Progress and Present Condition of the Mathematical Theories of Electricity, Magnetism, and Heat." *BAAS, Report for 1835*, 1–34.
- Wilkes, Charles. "Hydrography." In *Report of the United States Exploring Expedition during the Years 1838–42, volume 23*. Philadelphia, 1861.

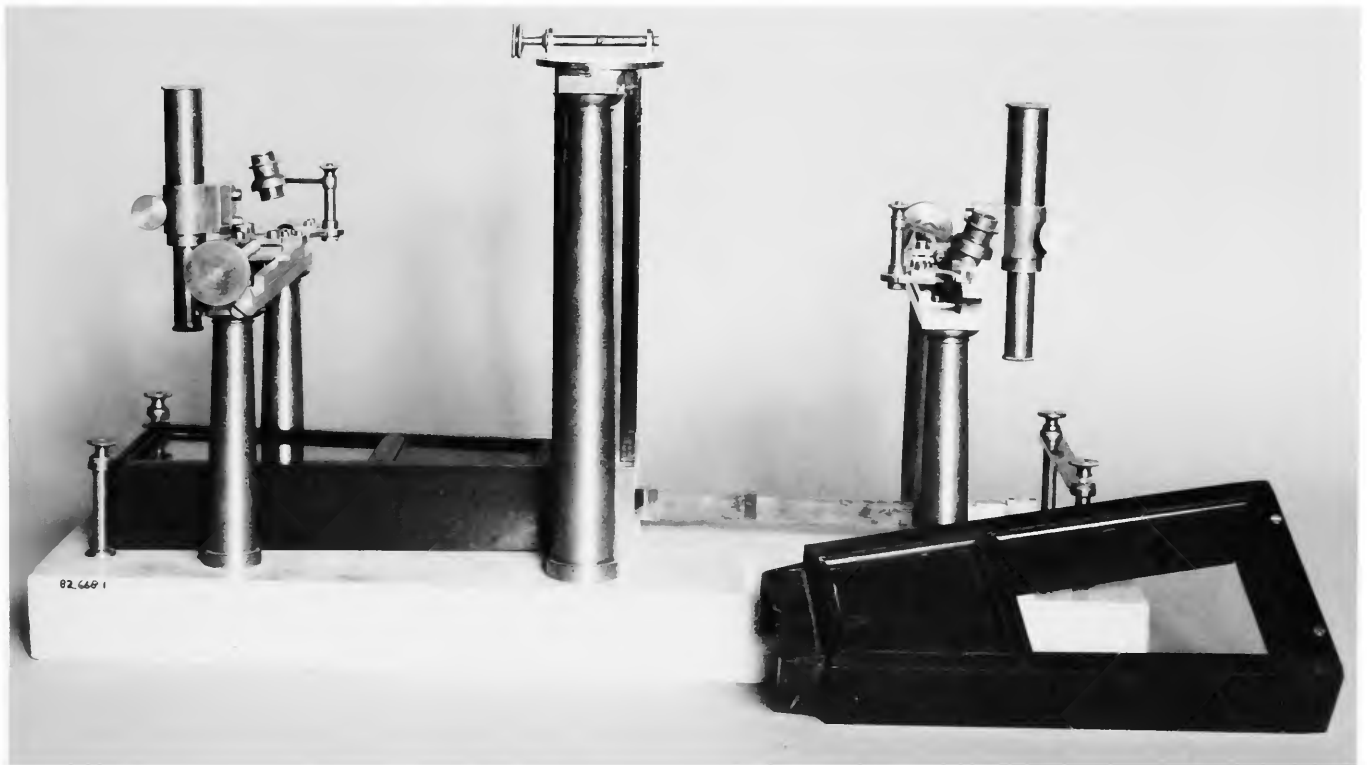

FIGURE 31.—No. 1, Declinometer, Gambey Type, ca. 1830.

Henri-Prudence Gambey (1787–1847), reputedly the favorite instrument-maker of Arago and Humboldt, came into prominence in 1819. During the next few years he made a number of intricate instruments, including an improved geomagnetic compass for Coulomb. The instrument shown exemplifies this fundamental Gambey instrument, as it was illustrated in textbooks for a half century. It is unmarked, and may have been made by another maker.

Construction is of marble, brass, and ivory, the 11½-in/49-cm bar magnet being supported by a thread, and its position being read by small microscopes on each end.

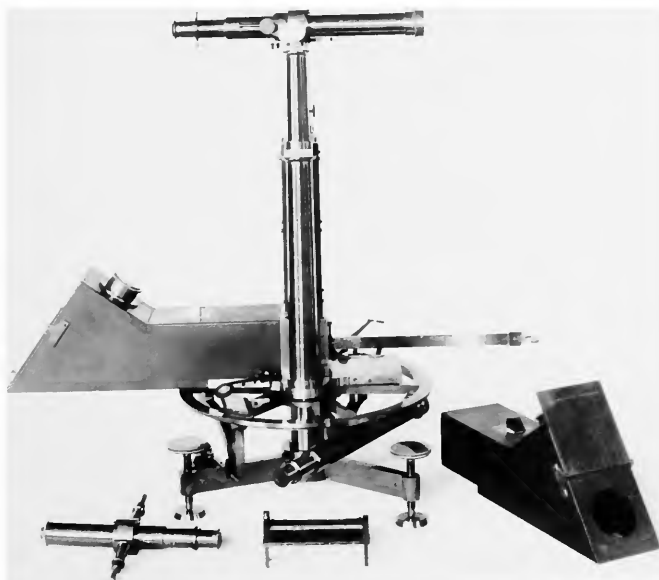

FIGURE 32.—No. 2, Variation Transit, Gambey.

This instrument was acquired by Alexander Dallas Bache during his European tour of 1836–1838, and was used to determine declination in Bache's magnetic survey of Pennsylvania, 1840–1843. It is a portable version of No. 1, Figure 31 in the present collection, and is smaller and lighter. It also includes a transit telescope for the determination of geographic north; thus its name, "variation transit."

The instrument was sold to the Cincinnati Observatory in 1869, given by them to the Carnegie Institution in 1915, and in 1959 to the historical collections of the Smithsonian.

[Reference: A.D. Bache, in *Smithsonian Contributions to Knowledge*, volume 13, 1863, Art. VIII.]



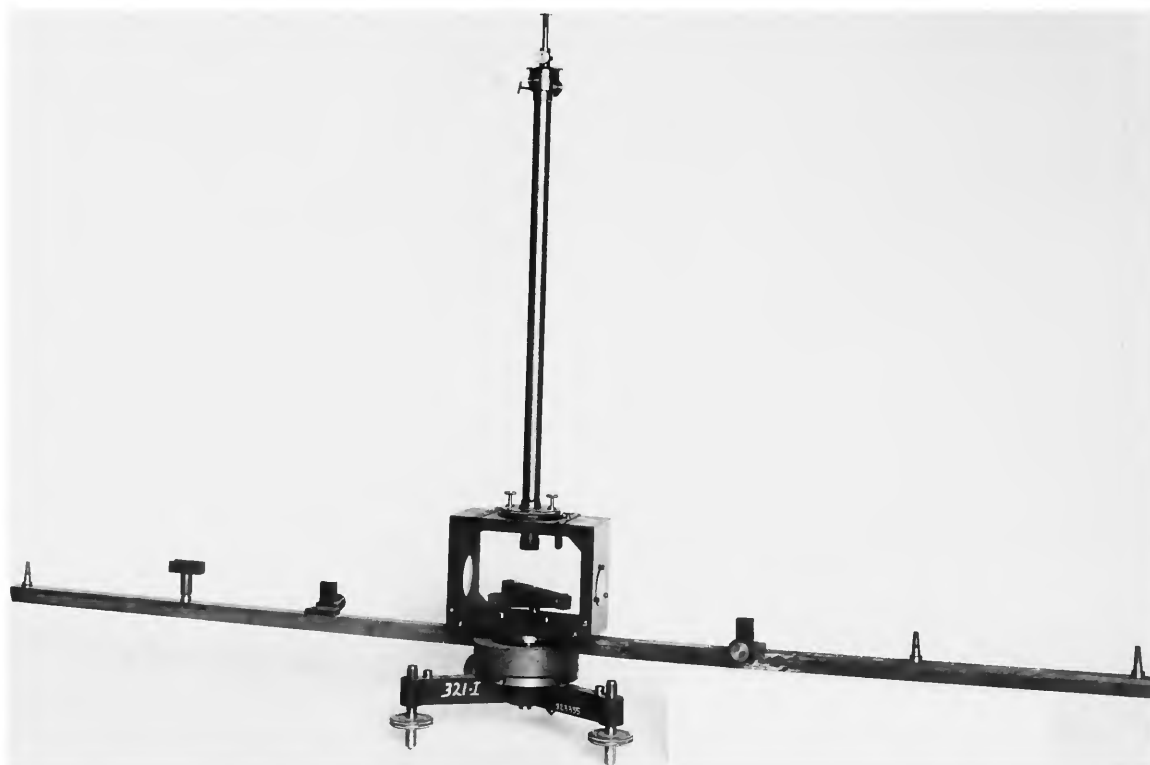

FIGURE 33.—No. 3, Magnetometer, mid-19th century.

This unmarked instrument shows the essential features of the simple Lamont magnetometer, with a short bar-magnet and horizontal supports for deflection bars (which are missing).

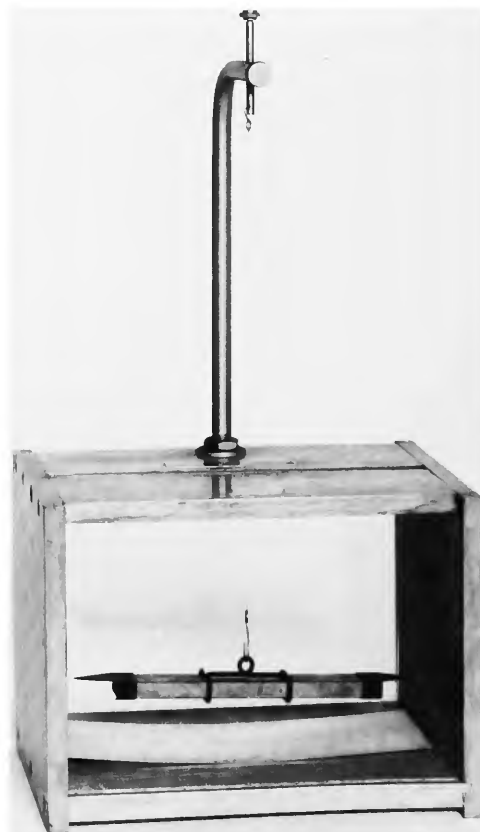

FIGURE 34.—No. 4, Magnetometer for School Demonstration, 1962.

This miniature instrument (the bar magnet is 4 in/9.2 cm long) was made by Griffin & George, Ltd., London. A virtually identical instrument is shown in J.B. Biot, *Précis élémentaire de physique expérimentale* (Paris, 1817), although subsequent texts describe it as "Weber's apparatus for observing oscillation."

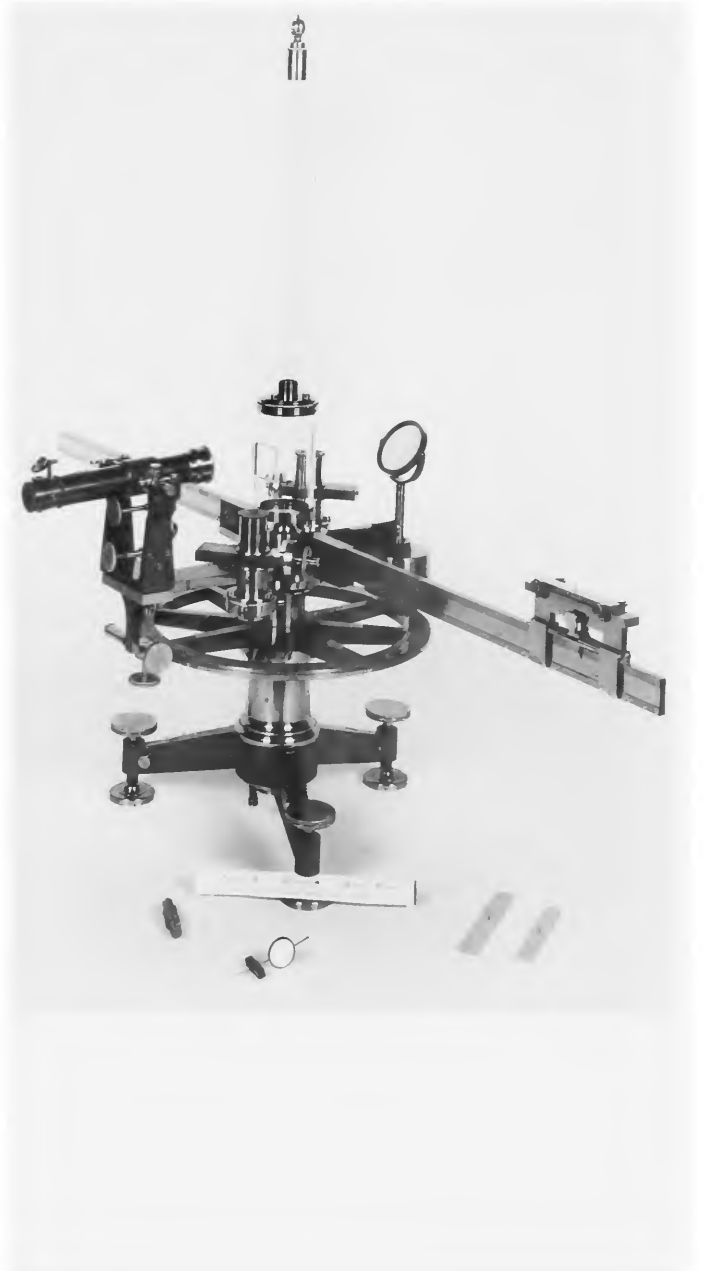

FIGURE 35.—No. 6, Magnetometer, Grunow, ca. 1870.

As shown at the left the instrument is set up for measuring declination; at the right, for intensity, by Gauss's method. The suspension tube is 39 in/99 cm long, the declination magnet is a one-in/2.5-cm bar.

William Grunow (1830–after 1900), a native of Berlin, came to the United States (New Haven, Conn.) in 1850, moved to New York City in 1861, and by 1873 was “established” at Columbia College (later University).

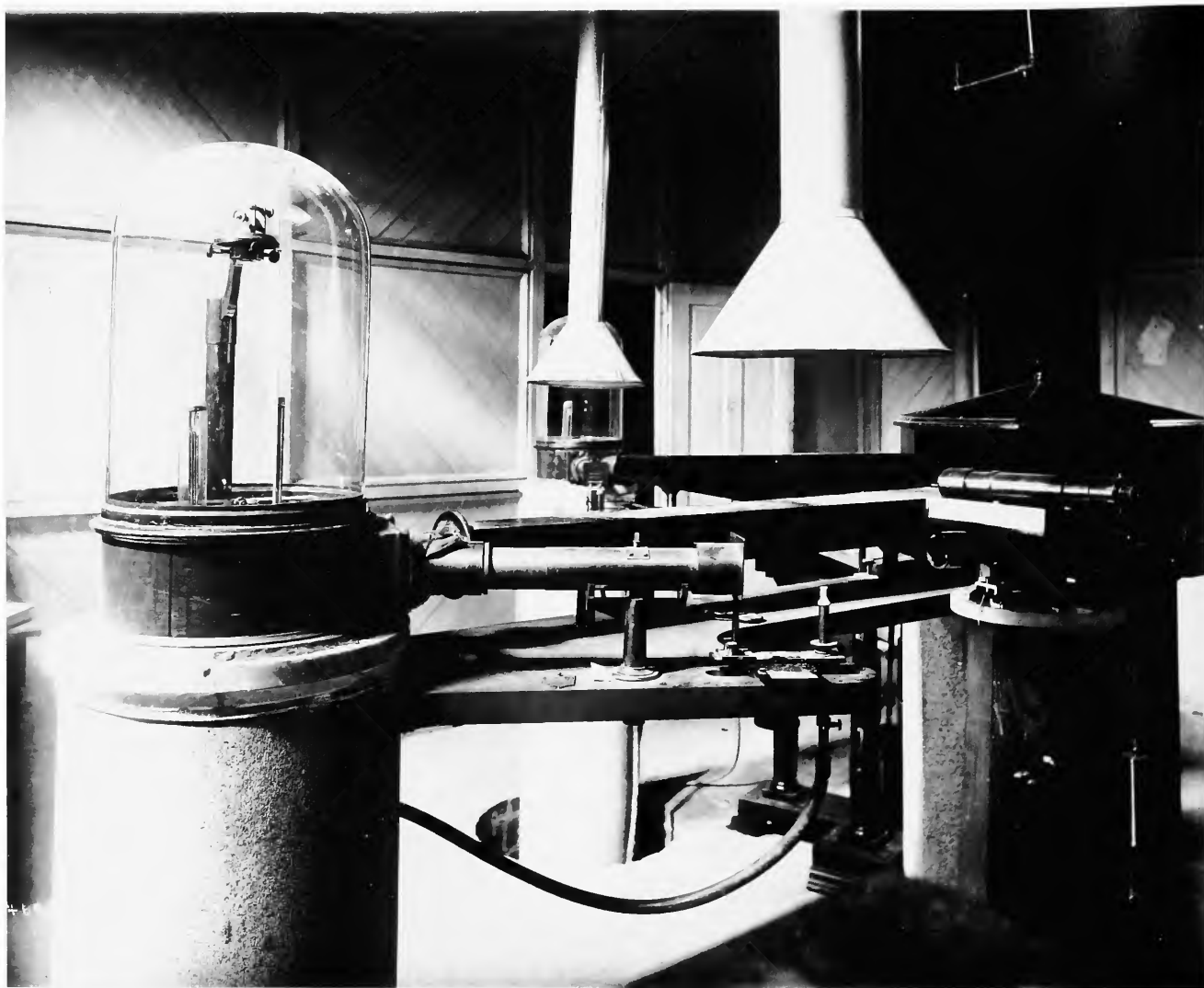

FIGURE 36.—No. 8, Magnetograph, Adie, ca. 1880.

For a general description of the Adie magnetograph see Figure 23. Shown here is the Coast Survey instrument, probably at its initial location, the Los Angeles observatory. In 1890 the instrument was moved to San Antonio, Texas, being transferred soon thereafter to the outskirts of the city to avoid electrical disturbances resulting from the introduction of the street railway. The San Antonio station was abandoned in 1895, but the Adie magnetograph was reinstalled at Cheltenham, Md., in 1902, as a back-up for the newer Eschenhagen-Töpfer variometers (No. 24, Figure 53) at the Survey's primary observatory. It was used for direct visual reading, and was still in use in 1942.

[References: *BAAS Report* for 1859. L.A. Bauer, in *TM*, 4 (1899), and in *CS Annual Report*, 1902.]

FIGURE 37 (facing page).—No. 9, Magnetometer, Kew Type.

A portable compound instrument, incorporating a theodolite, declinometer, and magnetometer, for measuring declination and intensity, designed at Kew Observatory and made by John Dover (1824–1881), or, more probably, his son.

On the use of the instrument see Figure 29. Kew instruments identical to this were illustrated as early as 1880, but this instrument may have been made later—or it was long in use. It was the property of the U.S. Navy Hydrographic Office, for which it was calibrated at the Coast Survey's Cheltenham, Md., observatory in 1945 and 1950. The same type was used by the Carnegie Institution in China and Africa in the early 20th century. [Reference: *CIW, Land Magnetic Observations, 1905–10* (Washington, 1912).]



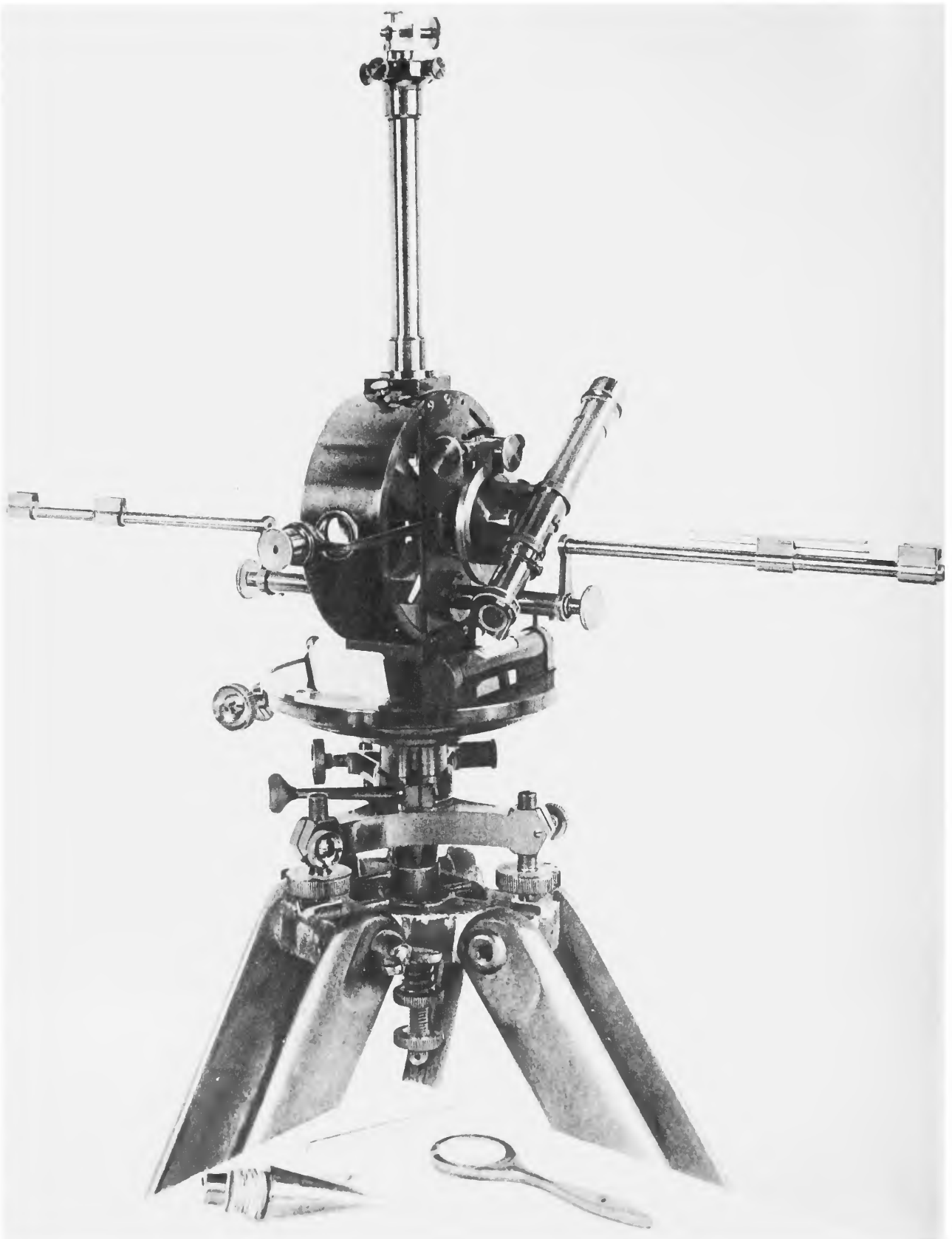

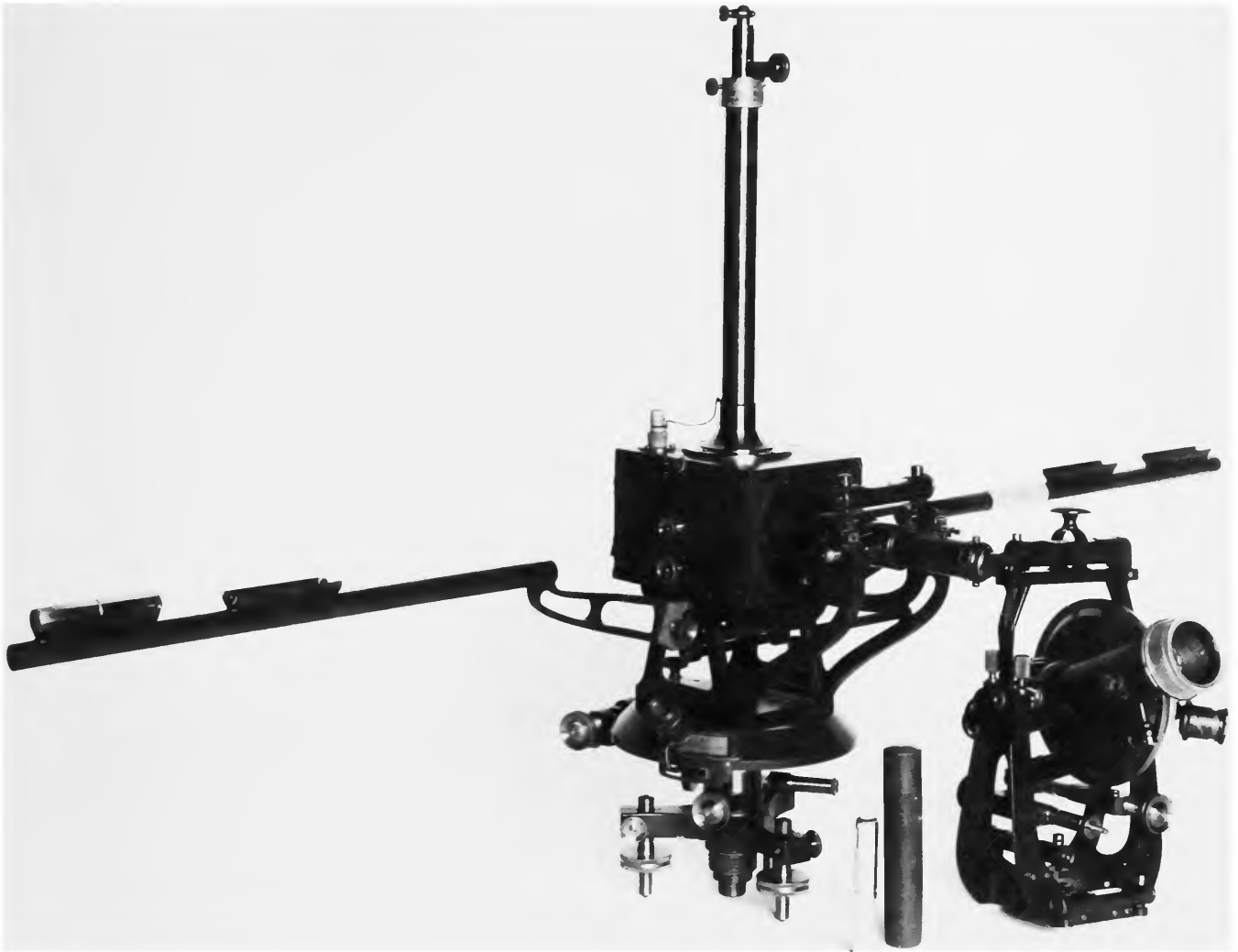

FIGURE 38 (facing page).—No. 10, Magnetometer, Brunner-Chasselon, ca. 1884.

Designed by Brunner and constructed by Chasselon, of Paris, this was the standard instrument of the French Magnetic Survey towards the end of the 19th century. Its principal feature was its diminutive size and portability. The magnet is a  $2\frac{1}{2}$ -in/6.4-cm cylindrical steel bar, suspended by a silk fiber and carrying concave mirrors, by which the user reads the direction through a microscope. There is also an integral theodolite.

The Coast Survey used this instrument for about a decade, it being a favorite of L.A. Bauer, for measurement of declination and horizontal intensity on his tours of inspection of observatories. Although defects were found, resulting in systematically low values (attributed to impurities in the brass housing) and in variations of torsion due to the light weight of the magnet, its readings were found to be consistent, and hence susceptible to compensation. Some use was also made of it in the early work of the Carnegie Institution.

The instrument was used in conjunction with the Chasselon dip circle (No. 35, Figures 61, 64).

[Reference: *Annales de Bureau Centrale Météorologique de France*, 1884.]

FIGURE 39.—No. 11, Field Magnetometer, Coast Survey, 1892–1893.

In 1890 a board was appointed by the Superintendent of the Coast Survey to consider the improvement of magnetometers, with which it now had fifty years of experience. The Survey's instrument shop cooperated in the design of this instrument, one of four constructed at this time.

Both the experimental and conservative sides of the agency are seen in this instrument. Its general form is that of the "theodolite-magnetometer" long in use; that is, a magnetometer and reading telescope are mounted on a single axis, with a separate theodolite for astronomical alignment. Changes were cautiously made: a slight increase in size, the use of octagonal magnets ( $2\frac{3}{16}$  in/6.5 cm long) in place of cylindrical ones, and the introduction of a black velvet tube between the telescope and the magnet housing, to block out air currents and external light. The octagonal magnets were designed to facilitate inversion and balance, but were found to be magnetically irregular and were abandoned. The design was on the whole successful, and these magnetometers were used in the comprehensive magnetic survey of the United States that began in 1899.

[Reference: *Coast Survey Annual Report for 1894*, pages 265–275.]





FIGURE 40.—Because geomagnetic instruments had to be transported, often manually, in rough terrain, the design of boxes for them was almost

as complex a task as the design of the instruments themselves. Shown here is our magnetometer No. 15, Figure 44 (CIW 4) in its box.

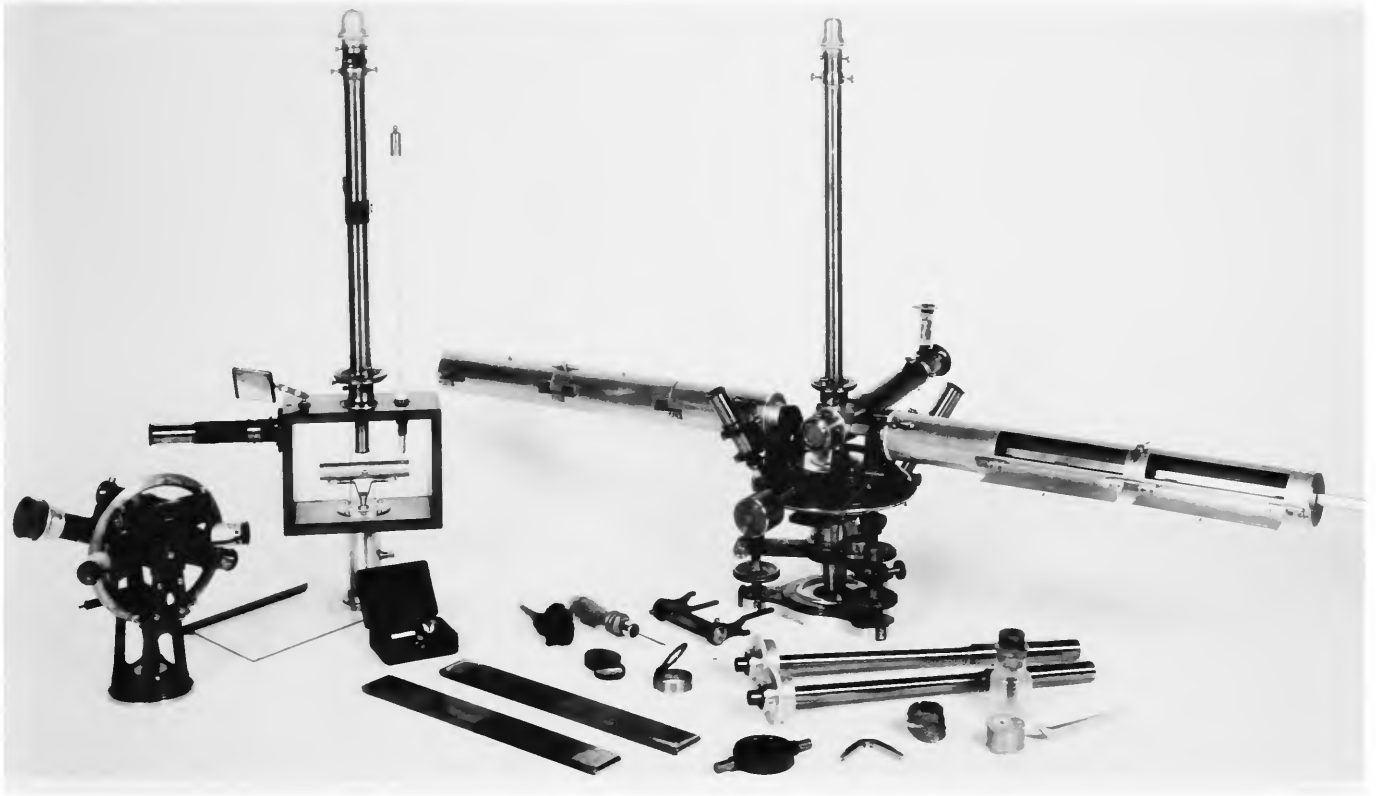

FIGURE 41.—No. 12, "Magnettheodolit," Eschenhagen-Tesdorpf, ca. 1900.

Described by the Coast Survey as "the Prussian field magnetometer," this instrument was designed by J.F.A.M. Eschenhagen (1858–1901), Director of the Prussian Magnetic Observatory at Potsdam, and built by the firm of L. Tesdorpf, of Stuttgart. It combines a theodolite, magnetometer (3.5-cm/1 $\frac{1}{8}$ -in magnet), declinometer and dip circle, on the same base. The arrangement for deflection is shown on the right, where the telescope is mounted on the same base as the suspension of the 2.9-cm/1 $\frac{1}{8}$ -in magnet, and moves around a vertical axis with the deflected image. The arrangement for declination, adjacent to the left, is also mounted on the same base.

The theodolite is shown at the far left.

Although it was advertised as portable, the Coast Survey acquired this instrument, about 1900, as an observatory instrument for its station at Sitka, Alaska, where it was used to calibrate field instruments used in the northwest part of the country. Its partial reassembly was required to switch from one measurement to another, and it appears to have been judged too complicated. It was retired about 1904, although subsequently used by the Carnegie Institution at Samoa and other Pacific Islands. [Reference: K. Haussmann, "Der Magnettheodolit von Eschenhagen-Tesdorpf," *Zeitschrift fuer Instrumentenkunde*, 1906, 26, pages 2–15.]



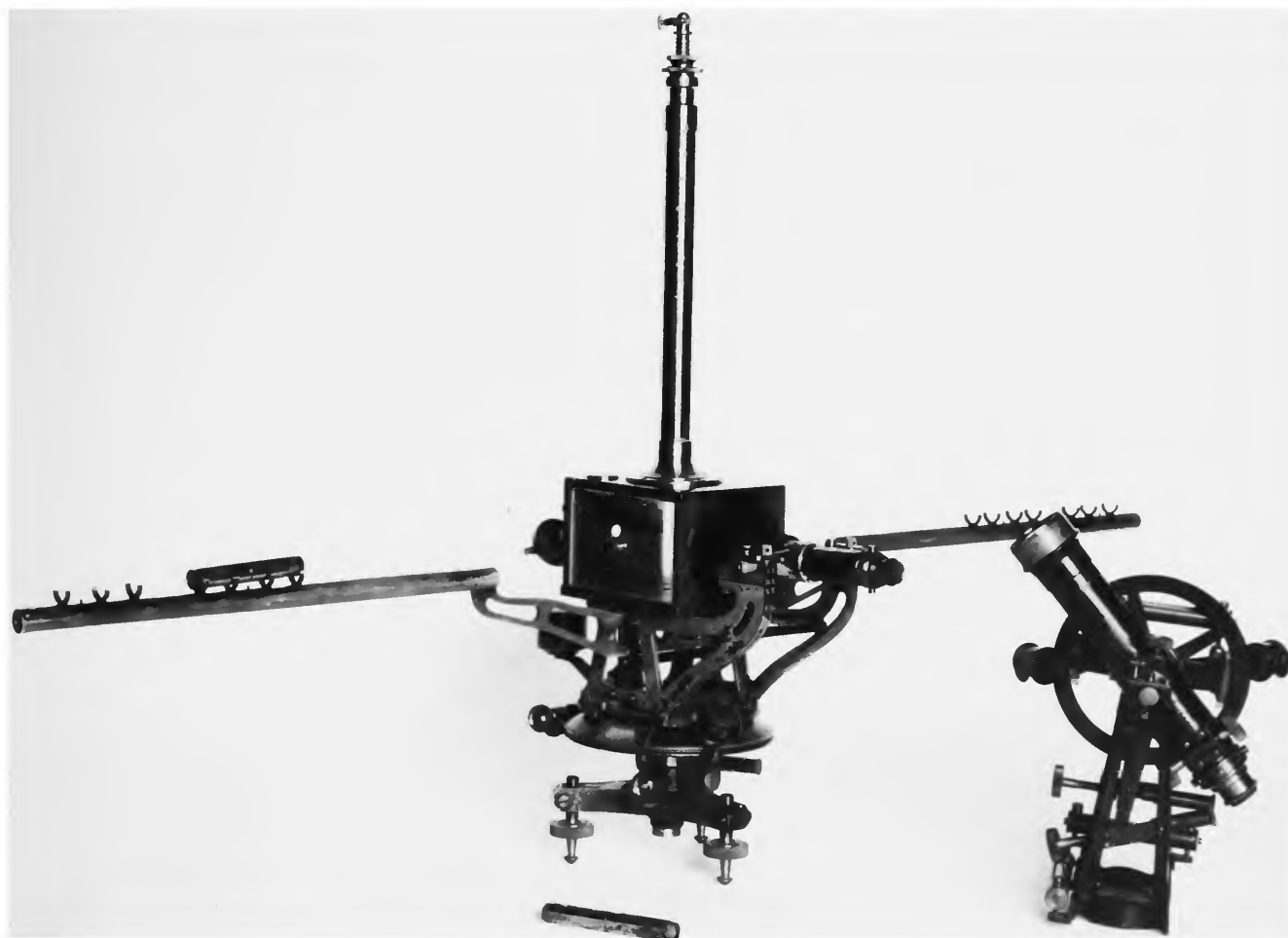

FIGURE 42 (facing page).—No. 13, Magnetometer, Wild-Edelmann, 1902.

This instrument derived from an 1893 design by Heinrich Wild (d. 1902), a Swiss who directed the Russian meteorological service from 1865 to 1895, and was built by M.T. Edelmann (1845–1913) in Munich. A “theodolite-magnetometer,” it represents a stage in a sequence of instruments descending from Gauss, through Lamont and Weber.

Although it was intended as a field instrument, its bulk and complexity were found too great for American use and the Coast Survey installed this example in the permanent observatory in Honolulu. It was used there until 1927, when it was replaced by a magnetometer of the India Survey pattern. [Reference: M.T. Edelmann, *Untersuchung über die Bestimmung der erdmagnetische Inclination*, 1881.]

FIGURE 43.—No. 14, Magnetometer, CIW 1, ca. 1902.

The early dependence of the Carnegie Institution’s Department of Terrestrial Magnetism on the Coast Survey is easily seen in its first instrument, which differs from the contemporary Survey instrument (see No. 11, Figure 39) only in minor details. The magnets have the same octagonal shape, it uses the same peculiar deflection bars, and the optical system is essentially the same. The instrument was constructed by the firm of Bausch, Lomb, and Saegmuller, of Washington and Rochester, N.Y.

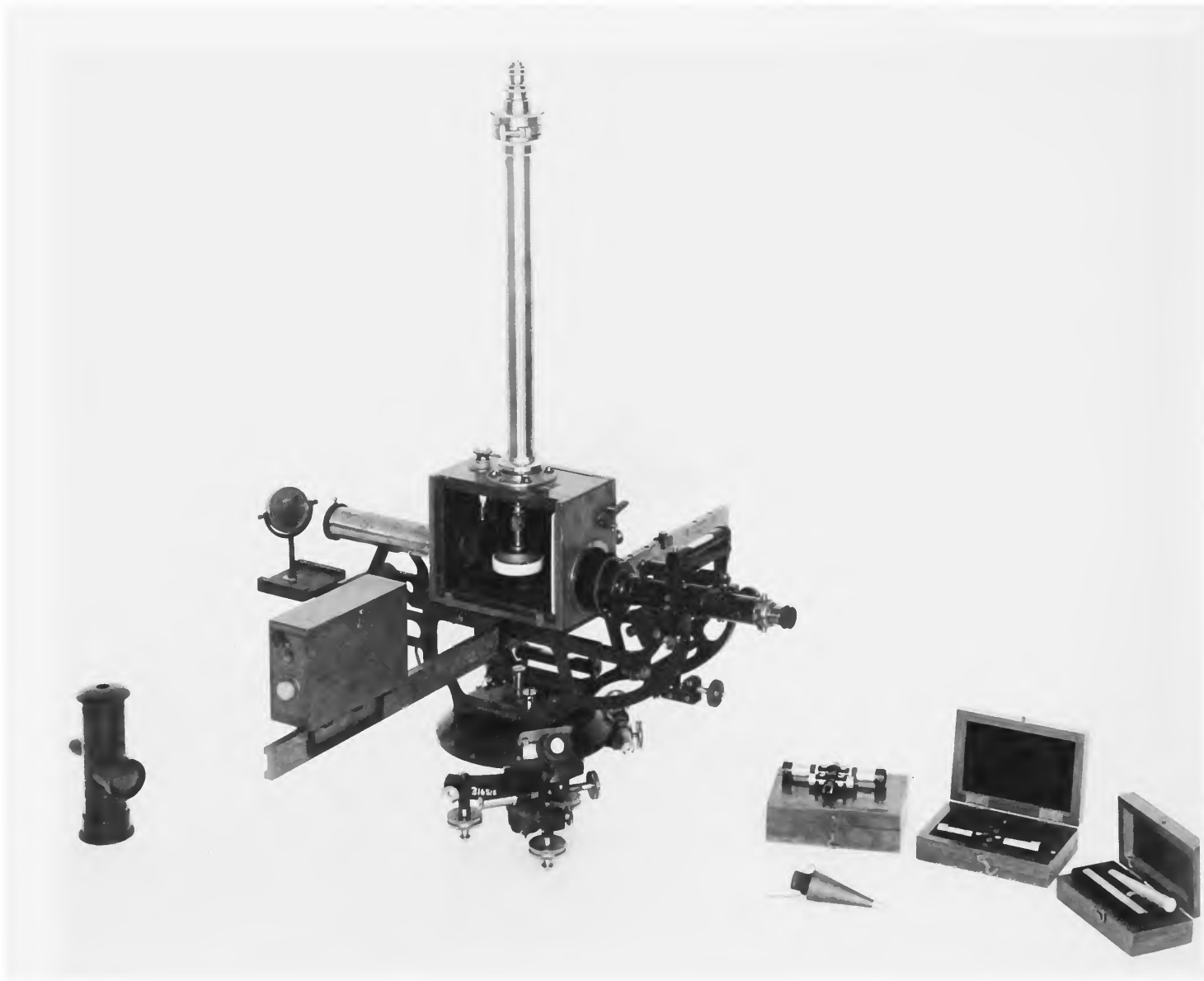

FIGURE 44.—No. 15, Magnetometer, CIW 4, ca. 1905.

After using borrowed instruments for a few years, improved instruments were designed at the Carnegie Institution, whose Department of Terrestrial Magnetism was headed by L.A. Bauer, previously head of magnetic work at the Coast Survey. This is no. 4 of type 1, and was modeled after the corresponding Coast Survey instrument and that of the British India Survey. It was made by Bausch, Lomb, and Saegmuller. Modifications included the replacement of hollow octagonal magnets with perfectly cylindrical ones "to eliminate questions . . . of irregularities." Magnets 1.4 and 3.0 in/3.5

and 7.5 cm, of equal weight, were enclosed in aluminum or gold-plated brass. The silk suspension was replaced with one of phosphor-bronze. A damping bar was adopted from the magnetometer of the India Survey (see No. 21, Figure 50). The principle defect of this instrument was its weight, 65 lb/29.5 kg.

The instrument was used on the CIW ships *Galilee* and *Carnegie*. [Reference: CIW, *Land Magnetic Observations, 1905-10* (Washington, 1912).]

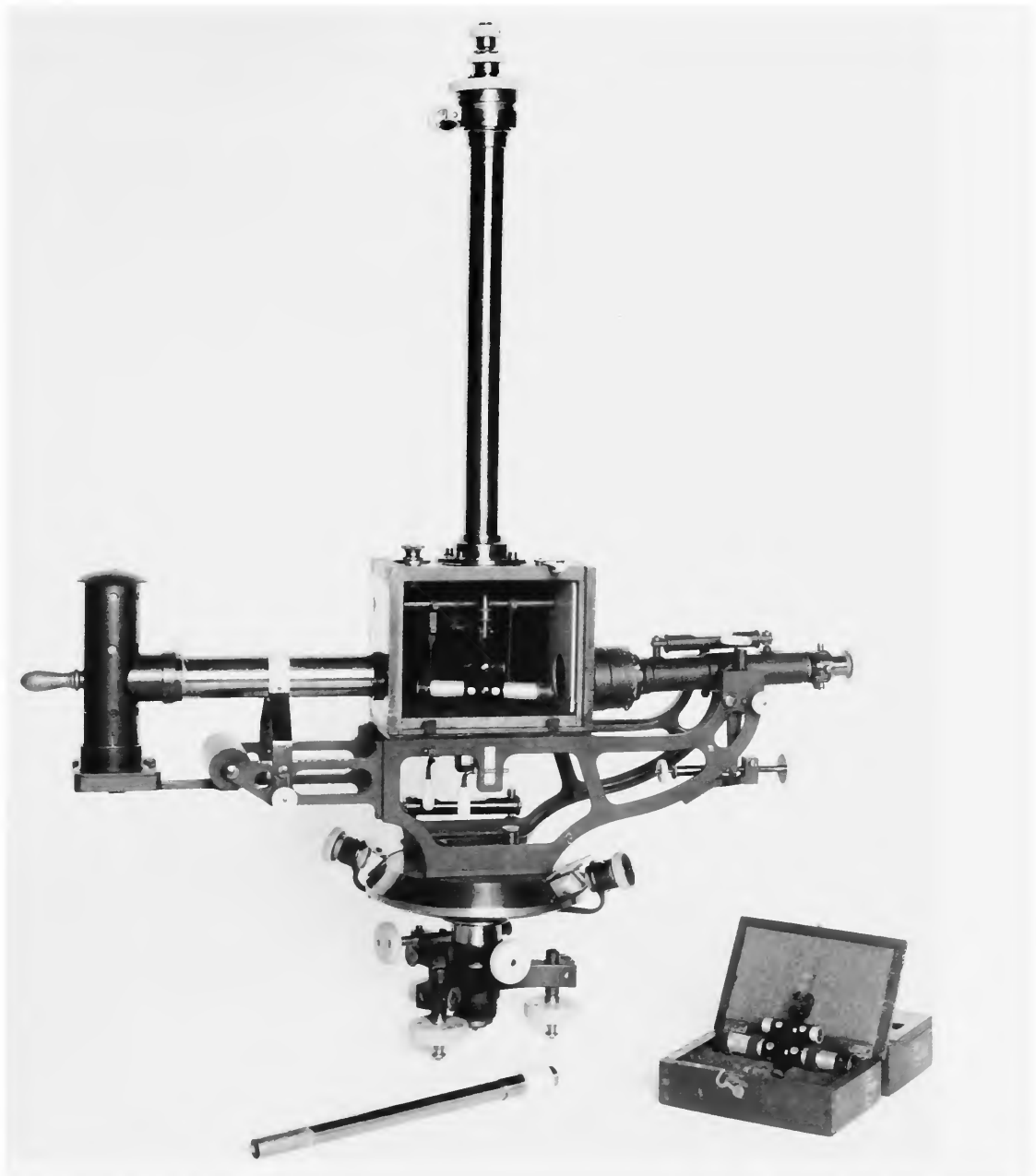

FIGURE 45.—No. 16, Magnetometer, CIW 8, 1906.

This is one of nine instruments made not long after 1905, constituting a "second generation" of Carnegie instruments, differing mainly in being lighter than the first. The cylindrical magnets are the same size as those in CIW 4 (No. 15, Figure 44).

This particular instrument was modified for use by Roald Amundsen (1872–1928) on his North Polar expedition, 1918–1920, the modifications involving sealing to avoid condensation and modification of the controls to facilitate use of the instrument while wearing heavy mittens. In addition,

all metal clamps and other parts frequently touched were covered with ivory-like celluloid.

The instrument accompanied Amundsen on the first voyage of the *Maud*, 1918–1920, as he drifted eastward from Norway to the Bering Straits, over the roof of Asia. The Carnegie Institution subsequently published the results.

[Reference: CIW, *Land Magnetic Observations, 1914–19* (Washington, 1921) pages 8ff.]



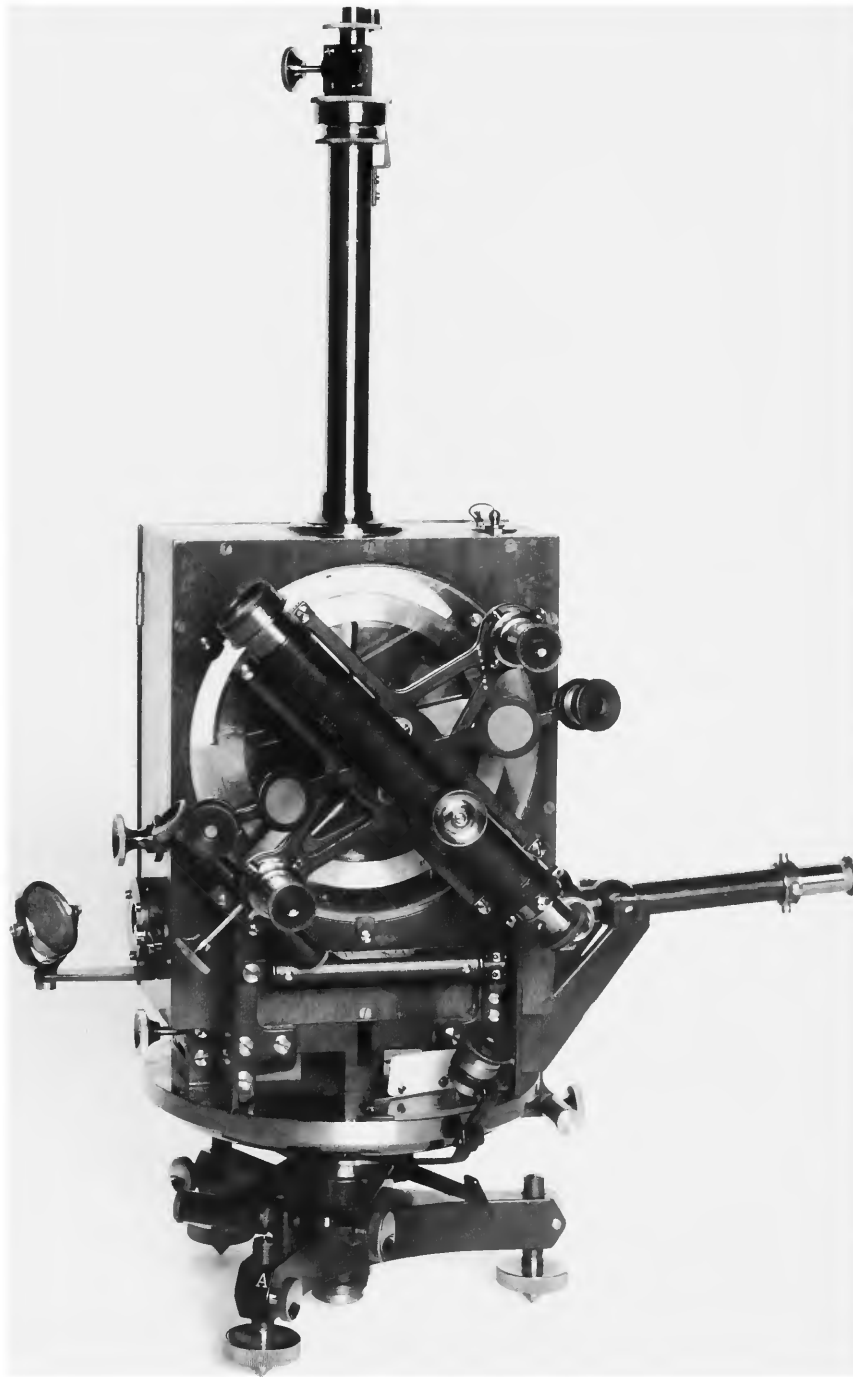

FIGURE 46 (facing page).—No. 17, Universal Magnetometer, CIW 19, 1911.

This instrument, one of five designed and built at the DTM, was more truly "universal" than earlier instruments so designated, since it incorporated a declinometer-magnetometer with a theodolite and a dip circle in a single unit and required little manipulation to switch functions. Its weight, 37.5 lb/17 kg, was only  $\frac{3}{5}$  that of the first generation of magnetometers designed by the Carnegie's DTM.

The instrument combines a magnetometer (with magnets 1 and 2.2 in/2.6 and 5.6 cm in length) and a dip circle, both located within a single box, the mounting of the magnetometer needle being moved aside for measurement of inclination.

[Reference: CIW, *Land Magnetic Observations, 1911-13* Washington, 1915.]

FIGURE 47.—No. 18, Universal Magnetometer, CIW 21, 1911.

Few instruments have traveled so much as this one. During 1911-1914 it was used in nearly every country of Central and South America, notwithstanding political turmoil (in Brazil it was escorted by a "Colonel-in-command of the revolutionary forces"). In 538 days in the field with a Mr. Powers it traveled 430 miles by sailboat, 705 miles by railway, 65 miles by handcar, 700 miles by canoe, 40 miles by coach, 110 miles by muleback, and 90 miles on foot with oxcart. In 1915-1916 it was used on the fourth cruise of the ship *Carnegie*, a circumnavigation, and it somehow survived the accidental burning of the *Carnegie* on its seventh and final voyage in 1929. Admiral Richard Byrd took it in 1934-1935 to his Antarctic base, Little America, whence it was carried by a research party to an interior plateau. Its service ended in 1937 on loan to Gulf Research and Development Company for exploratory surveying in Kuwait and Iraq.

Technically the instrument is nearly identical to CIW 19 (No. 17, Figure 46).

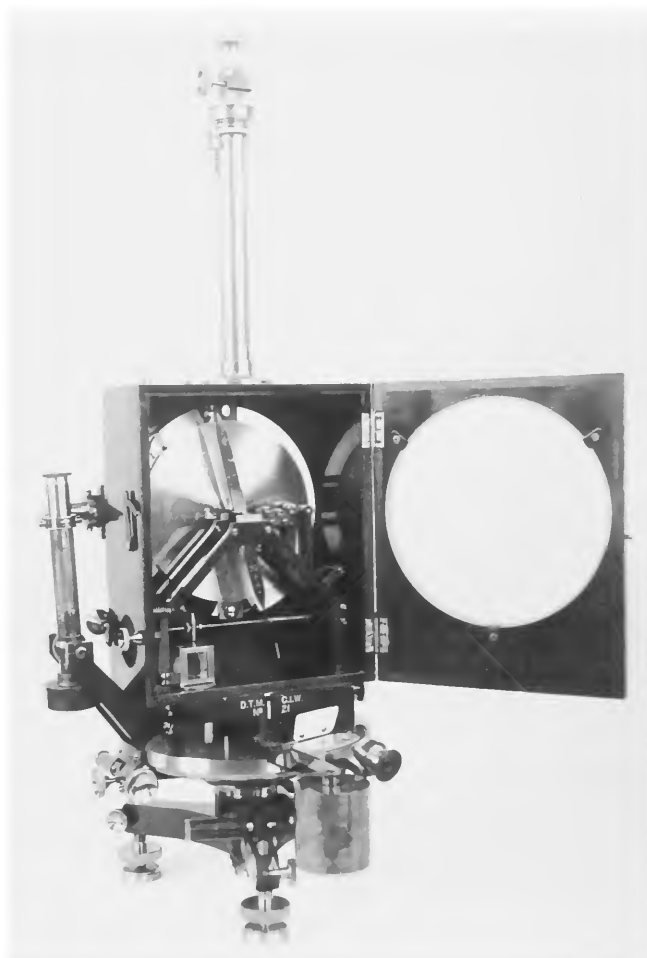

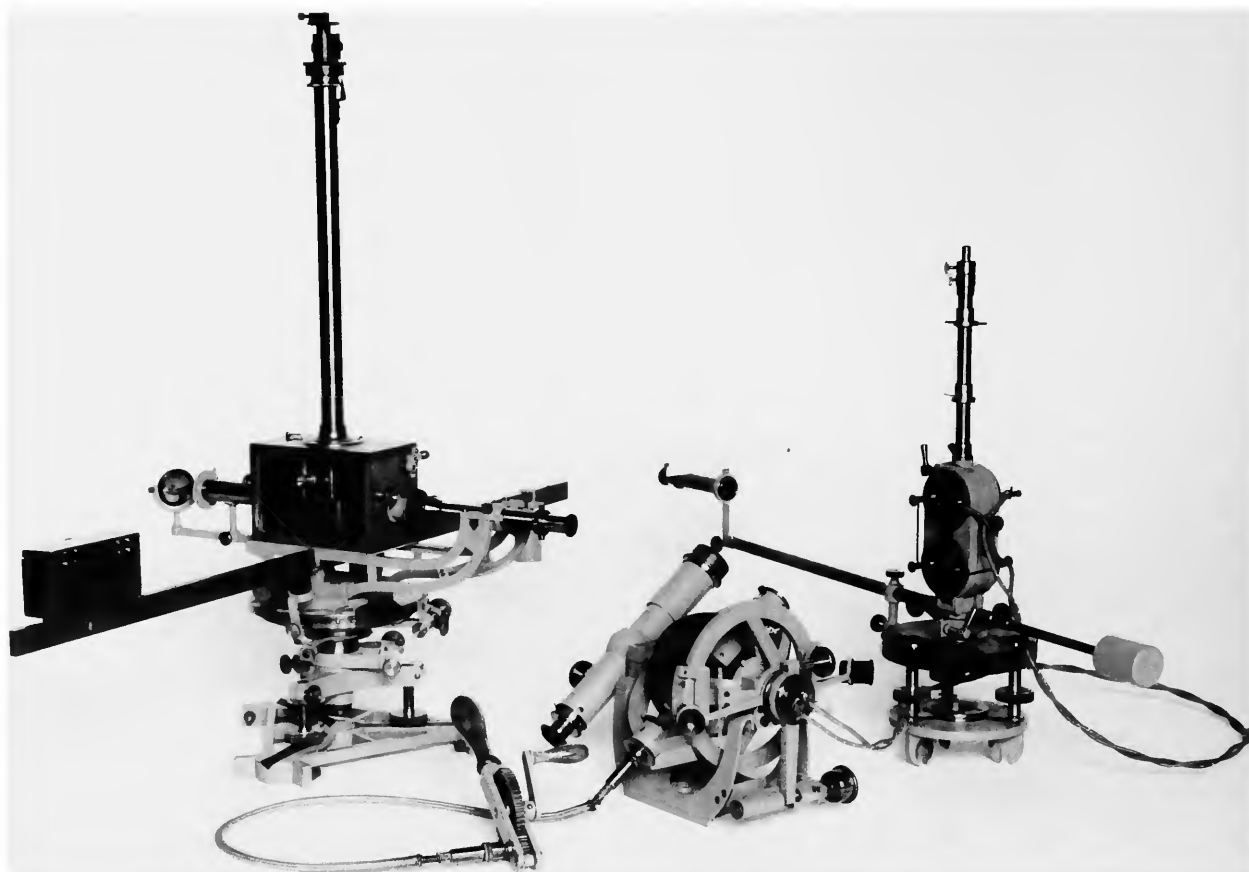

FIGURE 48.—No. 19, Magnetometer and Earth Inductor, CIW 26, ca. 1913.

The magnetometer (left), designed and built at the DTM, was a further improvement on CIW 21 (No. 18, Figure 47). The cylindrical magnets, suspended by phosphor-bronze wire, are identical to those of CIW 19 (No. 17, Figure 46).

The principal innovation was the replacement of the dip circle with an earth inductor (center, with its galvanometer to the right). The inductor, whose circle has an outer diameter of 2.8 in/71 mm, is the type used on land. It indicates the direction of the earth's magnetic field by a "null method." That is, when the rotor moves around its axis but is oriented in some other direction than the earth's field, a current is indicated in the galvanometer. The absence of this current indicates that its axis lies in the direction of the field. This direction is then read off a vertical scale, using two reading microscopes. Another telescope, mounted on the instrument and parallel to the axis of rotation, is used for geographic alignment.

The instrument is also notable for its light weight, 15.9 lb/7.2 kg (although the tripods and box increase the total to 48.7 lb/22.1 kg)

CIW 26 is mentioned in the Carnegie Institution report for 1911–1913, and was taken to England in 1915 for comparison with standard instruments at Kew and Greenwich. Later in that year it was at the Coast Survey observatory at Cheltenham, Md. Thereafter it was taken on tours almost every year for three decades, being used in the United States, South America, Africa, and on the sixth cruise of the ship *Carnegie*. One of its main functions was the redetermination of the magnetic elements at stations that had been "occupied" ten or twenty years earlier, providing data on the secular variation of the magnetic elements. It was also used to coordinate the observations of remote observatories, such as San Juan (Puerto Rico) and Huancayo (Peru).

[References: J.A. Fleming, in TM, 16 (1911), and (with J.A. Widner) 18 (1913).]



FIGURE 49.—Observation of horizontal intensity, with a magnetometer that is similar to No. 19 (Figure 48), November 1930. R.R. Bodle, standing; W.M. Hill, recording.



FIGURE 50.—No. 21 (?), Magnetometer, British India Survey Pattern.

This instrument is used to determine deflection and intensity, the latter by vibrations, employing a cylindrical magnet 3.65 in/9.3 cm long, suspended by a thread of phosphor-bronze. The magnet is observed through the telescope, which contains a scaled optical glass and is illuminated by an oil lamp.

This type of magnetometer apparently dates from 1906, when six

instruments were supplied to the British India Survey. All were made by the firm of Cooke & Sons of London, as were one or more instruments later acquired by the Coast Survey. The instrument shown here, in use at the Sitka, Alaska, observatory, may not be our No. 21. Ours is, however, shown in Figure 74, with the Nelson induction apparatus. [Reference: TM, 6 (1901), pages 65ff.]

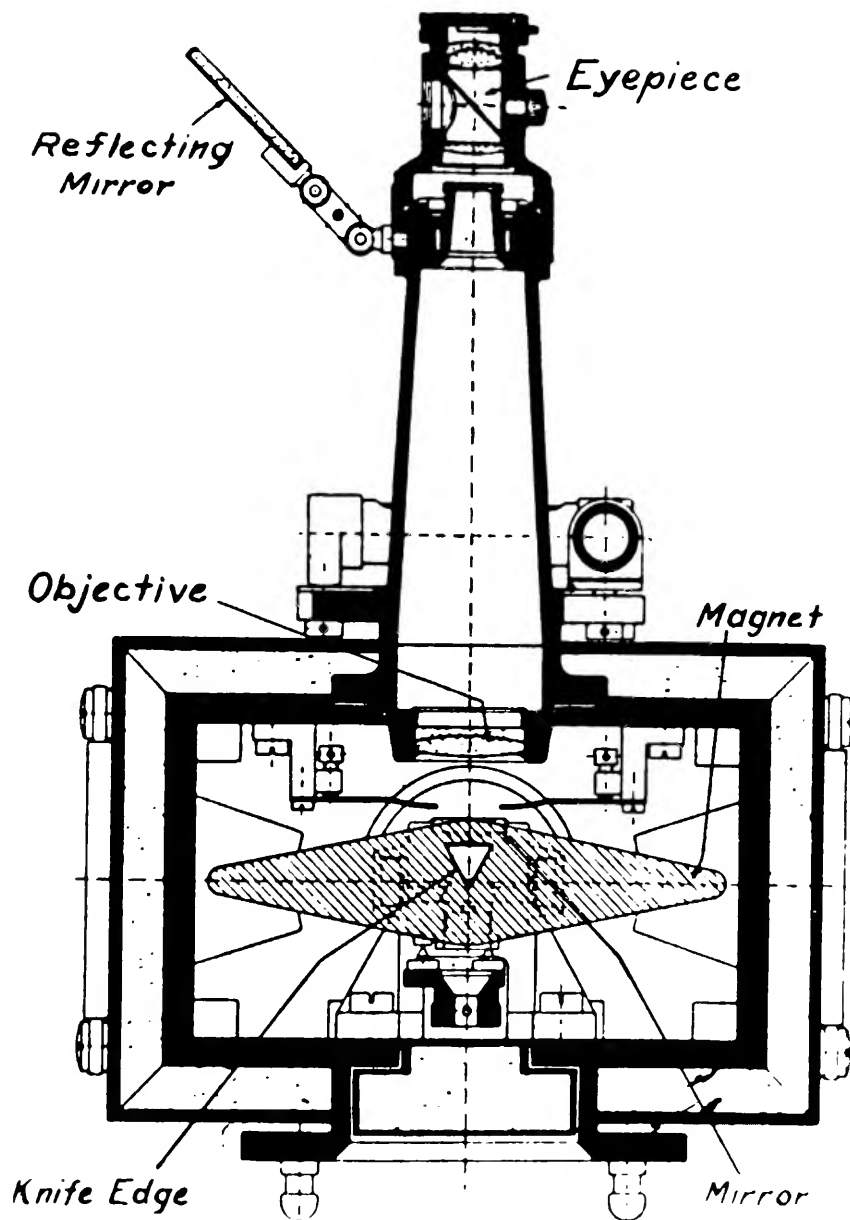

FIGURE 51.—No. 22, Magnetometer, Schmidt.

Invented by Adolf Schmidt in 1915, this "magnetic vertical balance" represents a refinement of Lloyd's vertical force magnetometer (see text and Figure 18). The instrument, which is essentially a variometer, is oriented in the magnetic meridian through the use of a separate compass. The deflection of the magnetized balance beam is then measured through an optical system visible through the small telescope at the top.

With this instrument the scientific and the prospecting magnetometers

became one. Instruments of this type have been used in mineral prospecting in the United States since the 1920s. Our example was made by Gulf Research and Development Corp. of Pittsburgh.

Shown here is a cross-sectional drawing of the instrument.

[References: *Berichte über der Taetigkeit der preussische meteorologische Institut* (Berlin), 1915-1916, TM, 21 (1916), pages 32, 33. The drawing is taken from J.A. Fleming, *Terrestrial Magnetism and Electricity*, New York: McGraw-Hill, 1938, page 120.]



FIGURE 52.—No. 23, Variometers, Edelman, ca. 1890.

Thomas Edelman, of Munich, was one of the most prolific designers of magnetic apparatus in the late 19th century. He was famous both for the complexity and the massiveness of his designs. Coast Survey magnetometer 22 (No. 13, Figure 42) clearly exhibits the first quality, and these two variometers display the other. Marble is used extensively in these instru-

ments, and especially in the 48-in/122-cm high declination variometer (right, the needle, about 5 in/13 cm long, is missing). They were used with light sources and photographic recording apparatus similar to that shown in Figure 30.

[Reference: M.T. Edelman, "On the Construction of Earth-Magnetic Instruments," United States Weather Bureau, *Bulletin 11*, 1894.]





FIGURE 53.—No. 24, Variometers, Eschenhagen-Toepfer, ca. 1900.

These instruments measure variations in declination (left, 20 $\frac{7}{8}$  in/53 cm high) and horizontal intensity (right). The magnet housings are 1 $\frac{1}{2}$ -in/3.8-cm square bronze boxes. A third instrument, not in the collection, measured vertical intensity. They were used at Cheltenham, Md., Honolulu,

and at Baldwin, Kansas. These (or similar instruments) are shown in Figure 54 being tested at the Carnegie Institution.

Variometers require frequent calibration against "absolute" instruments, such as Coast Survey magnetometer 18, (No. 11, Figure 39).

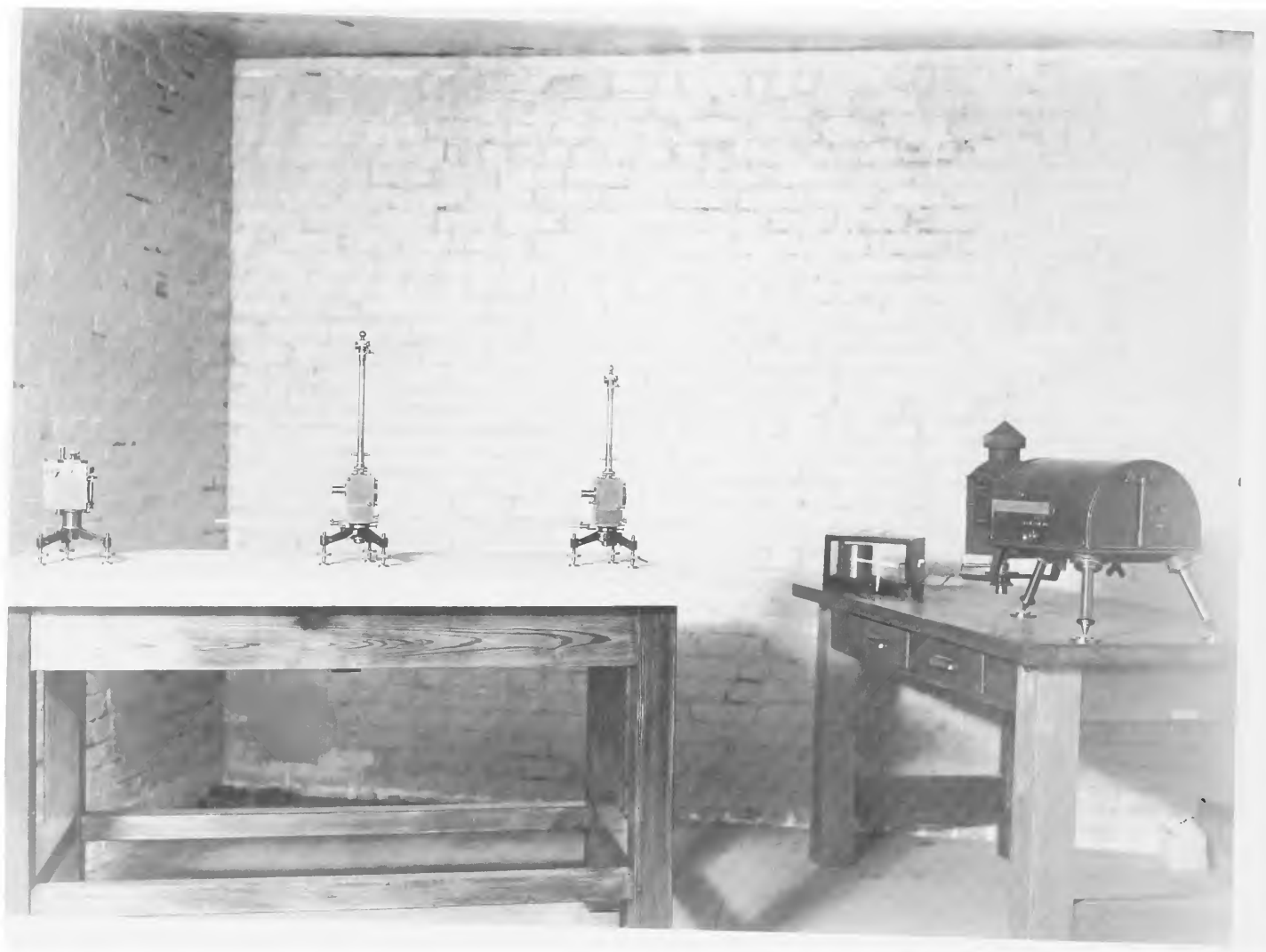

FIGURE 54.—Eschenhagen-Toepfer variometers mounted for tests at the DTM, May, 1916. The two tall instruments are similar, if not identical, to those in the present collection (No. 24, Figure 53).

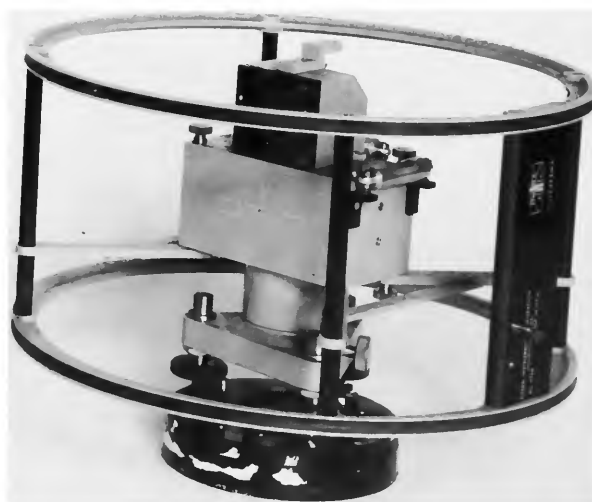

FIGURE 55 (upper).—No. 25, Variometers, Ruska, 1950s.

The effort to incorporate electrical methods into the measurement of the earth's magnetic elements was one of the most important instrumental developments of the first half of the 20th century. It was made possible by the development of apparatus capable of maintaining a constant magnetic field. In these instruments, made by the Ruska Instrument Co. of Houston, Texas, the field is supplied by 12-in/30.5-cm Helmholtz coils that surround the magnet housings.

The instruments are for determining changes in vertical force (left, 0.4-in/1-cm needle) and both declination and horizontal force (right, 3.1-in/8-cm needle).

FIGURE 56 (lower).—Ruska variometers at Cheltenham, Md., observatory, about 1960. The instruments are for measuring vertical intensity (right), declination (center), and horizontal intensity (left). The box on the far left contains the photo recorder.

FIGURE 57.—No. 26, Magnetometer, Airborne, Gulf, ca. 1940.

Developed in 1940 at the Gulf Research and Development Company, for the primary purpose of mineral exploration, this instrument generates a steady magnetic force, induced by an electrical system within the instrument. This magnetic force varies in response to changes in the ambient field, that is, the earth's magnetism in the vicinity.

The instrument is designed to avoid the effects of shock by eliminating mechanical parts, measuring instead the saturation effects of the magnetic environment on high-permeability magnetic material such as permalloy (a magnetic alloy of nickel). Nevertheless, because of the vibration and instability of the aircraft, the instrument was towed behind the plane in a torpedo-like housing, called the "bird."

Only the "bird," 55¾ in/142 cm long (sectioned to show the interior), is shown in this illustration.

[Reference: Gary Muffley, "The Airborne Magnetometer," *Geophysics*, 11 (1946).]



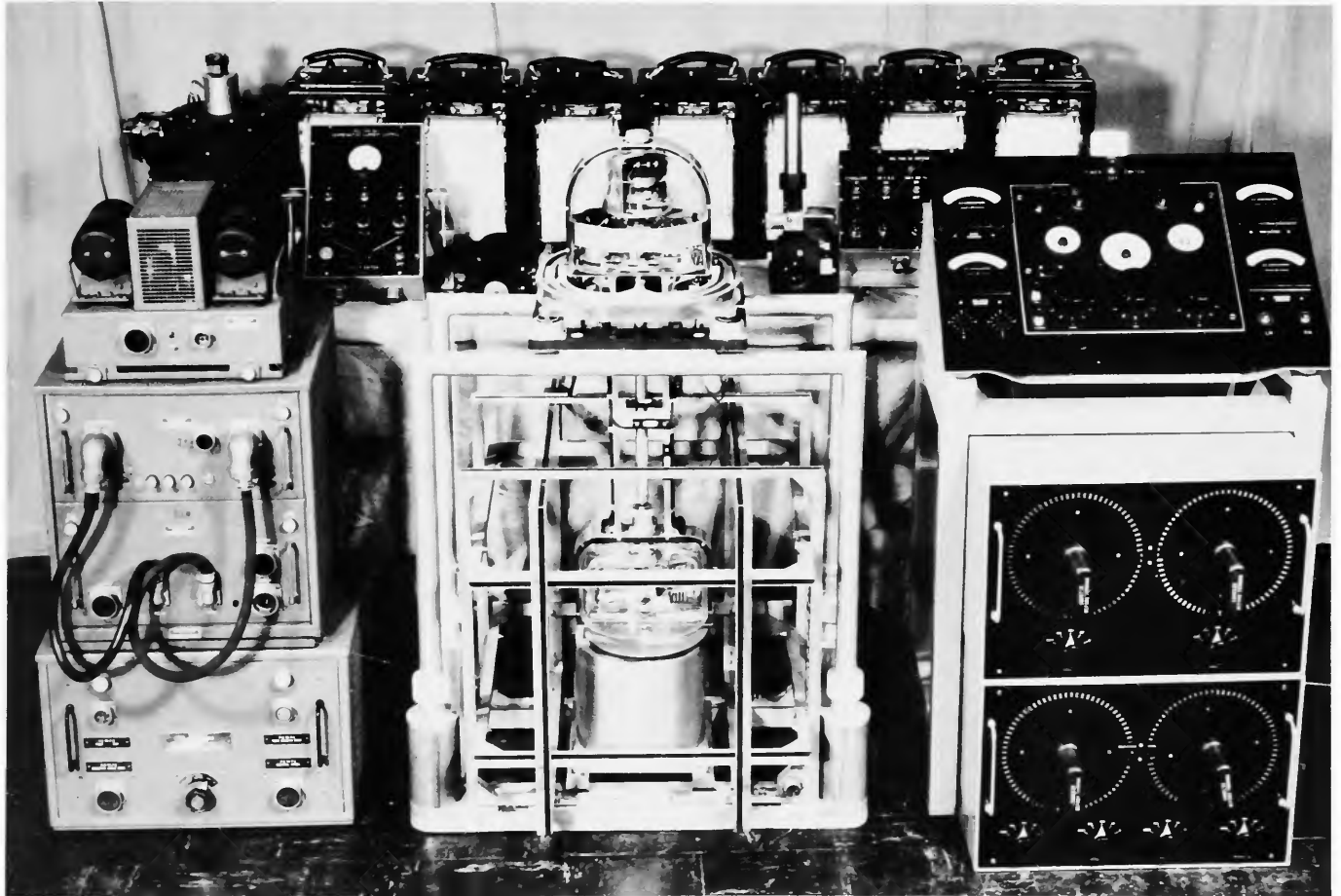

FIGURE 58.—No. 27, Magnetometer, Airborne, U.S. Naval Hydrographic Office, VAM-2B3, 1953.

Experiments made in the early 1940s on the possibility of submarine detection with the airborne magnetometer used the recently introduced Gulf instrument (No. 26, Figure 57). They were sufficiently promising to justify a "crash program" for the improvement of the instrument which, as was typical of wartime research, involved many institutions, including Columbia University, the General Electric Company, the Sperry Gyroscope Company, the Naval Ordnance Laboratory, and the Bell Telephone Lab-

oratories. The result was MAD (Magnetic Airborne Detector), a complex system in which the sensing element was located within the aircraft.

The sensing unit (35.54 in/90 cm high) is in the center of this photograph, which shows all components. It continuously records the total intensity of the field and the magnitudes of directional angles. This is the second version (Type 2A) of the instrument.

[Reference: E.O. Schonstedt and H.R. Irons, *Trans., American Geophysical Union*, 36 (1955), pages 25-41.]

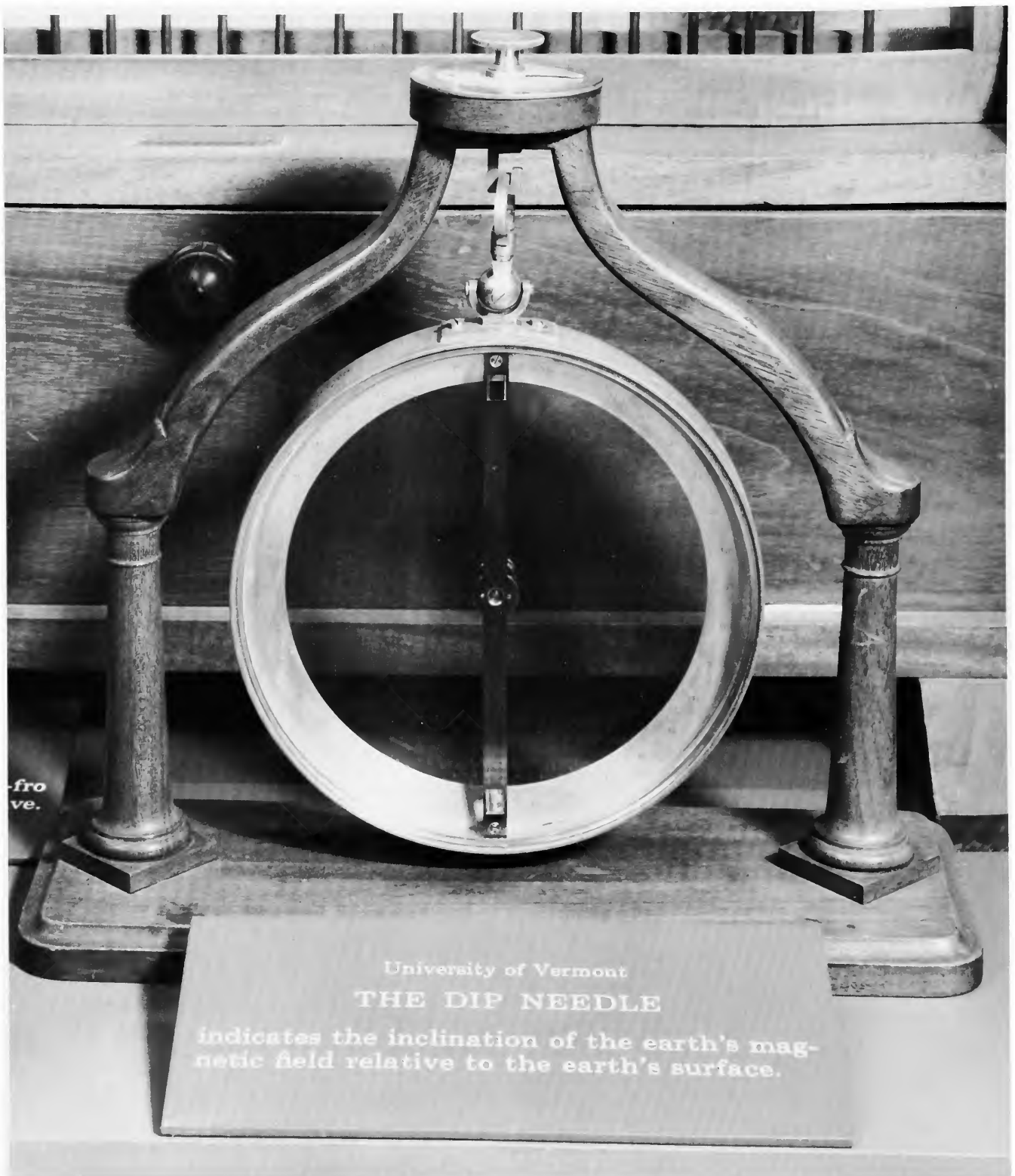

FIGURE 59.—No. 28, Dip Circle, for classroom demonstration, early 19th century.

This instrument, used at the University of Vermont, has the ornate construction typical of apparatus used for demonstrating science at that

time. It was easily oriented, using the circular scale at the top. The 6-in/15.2-cm needle, jewel mounted, is hidden in the photograph by the vertical mounting bracket.



FIGURE 60.—No. 30, Dip Circle, Barrow, ca. 1860.

Henry Barrow (1790–1870), successor to the celebrated English instrument-maker, T.C. Robinson (d. 1841), supplied magnetic instruments to the U.S. Naval Observatory in the early 1840s, and subsequently to the Coast Survey, which reported Barrow circles to be the standard instrument as late as 1877.

This instrument, CS 9, is presumably earlier than CS 10 (No. 31, Figure 61), which was in use in 1863. Details of its employment are unknown. The position of the  $9\frac{1}{2}$ -in/24-cm needle is read by two magnifying lenses 180 degrees apart.

[Reference: Coast Survey, *Annual Report*, 1872.]



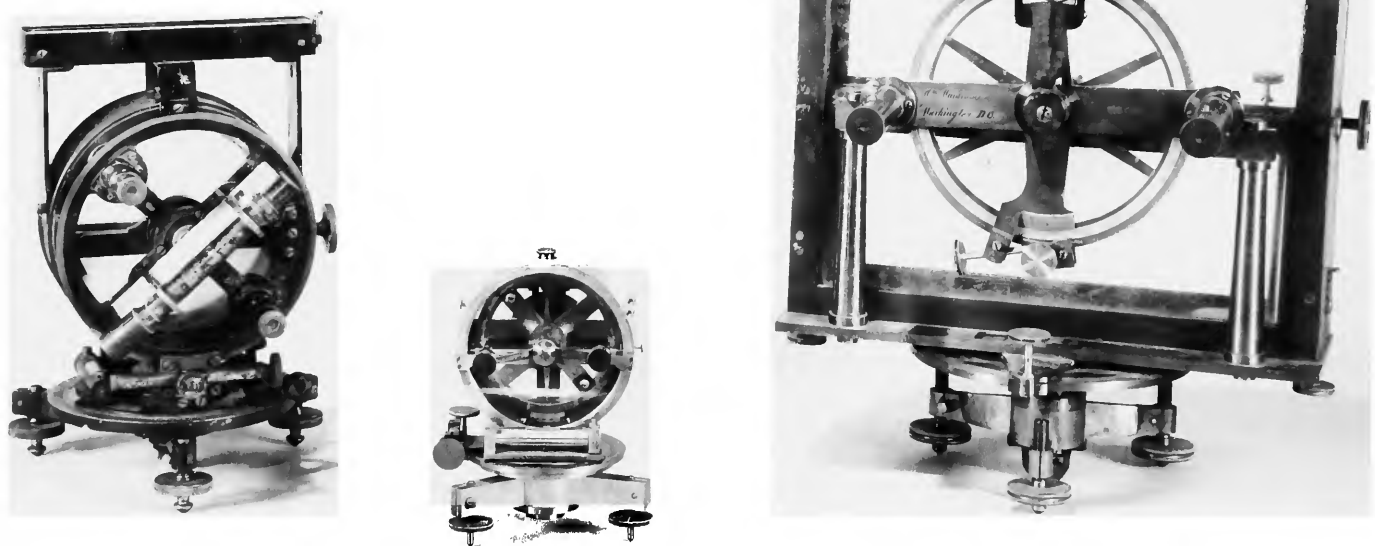

FIGURE 61.—Nos. 31, 35, 38, Inclinometers (Dip Circles), ca. 1860–1900.

The instrument at the right (No. 31) was made about 1863 by William Wurdemann (1811–1900), a native of Bremen. Wurdemann was brought to the United States by the first Director of the Coast Survey, F.R. Hassler, in 1834. He resided in Washington until his death, working intermittently for the Survey (1834–1836, 1848, 1870–1874) and as an independent instrument maker. He made some of the early instruments of the survey, including this one, apparently made while he was in private business. The

needle (missing) was about 9 in/23 cm long. The instrument was used in Washington in 1863 and subsequently at many other locations, including points on the west coast from Sitka to San Diego in 1881.

Shown in the center is the Bruner-Chasselon dip circle (No. 35) whose 2.75-in/7-cm needle is located within a 3 $\frac{7}{8}$ -in/9.9-cm circle. This instrument is also illustrated in Figure 64.

At the left is a Lloyd-Creak dip circle (No. 38) which is nearly identical to No. 37, Figure 65.

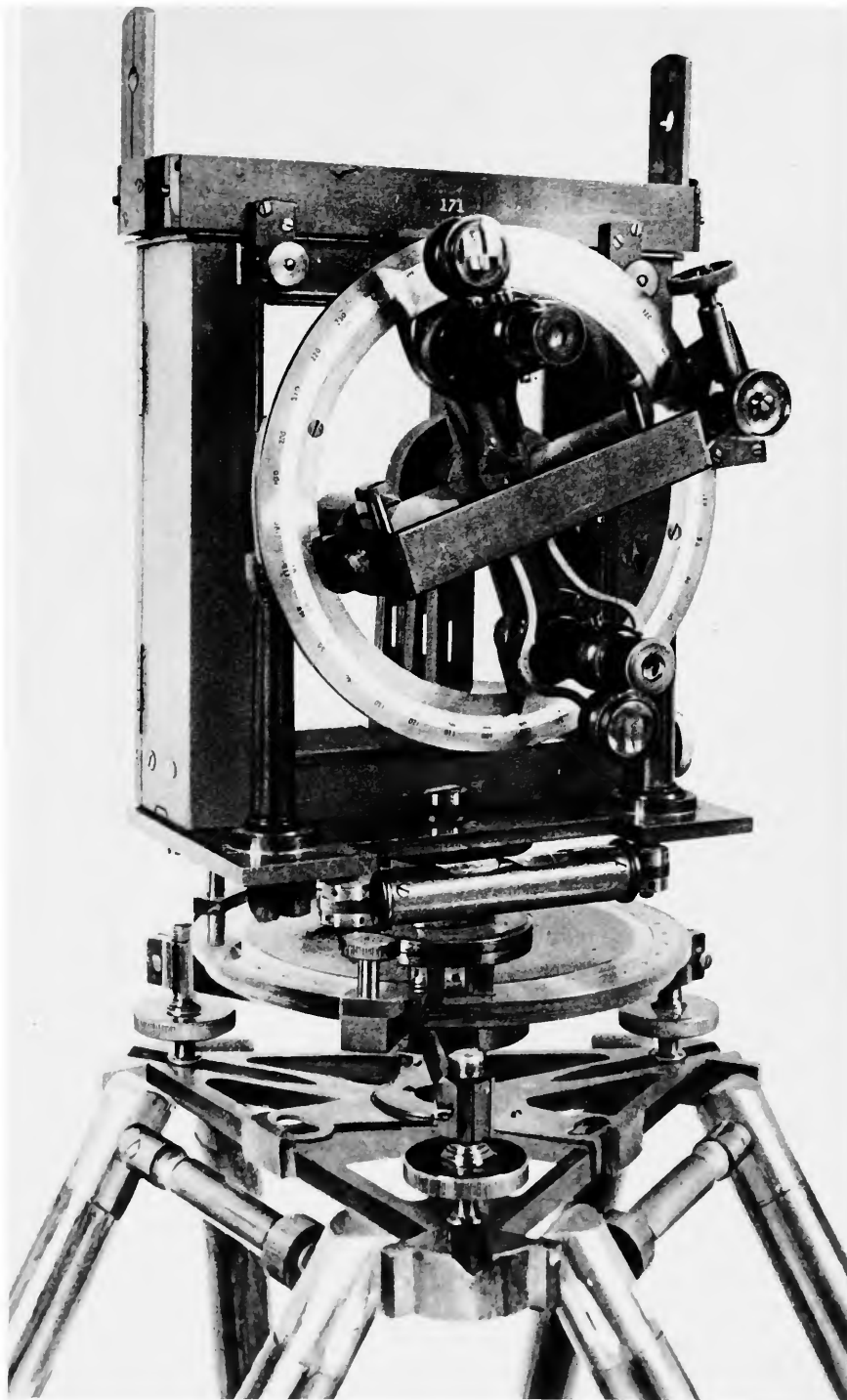

FIGURE 62.—No. 34, Dip Circle, Dover 85, ca. 1880.

This type of circle became the most common in the United States in the late 19th century, and was commonly known as the Kew dip circle regardless of the maker. The housing for the 3-in/7.6-cm needle (which is missing) is a rectangular wooden box with a glass front and back, and the scale and

reading mechanisms are mounted in front of the box. A special mounting for a deflection magnet was usually installed on the reading mechanism, to allow the total intensity to be determined by Lloyd's method, in which the position of the needle with and without an adjacent deflecting bar are compared.



FIGURE 63.—Nos. 33, 36, 40, Dip Circles, Dover.

These three dip circles are similar to Dover 85 (Figure 62). The instrument at the left is our No. 33. That in the center, No. 36, was used during the International Polar Year, 1932–1933. The instrument at the right is our No. 40.

John Dover (1824–1881), of London, was an apprentice of T.C. Robinson, and although Henry Barrow became Robinson's successor, Dover went into the business independently. He exhibited a balance at the Great Exhibition of London, 1851. By 1869 he had moved to (New) Charlton, Kent, not far from the Royal Observatory at Greenwich. In 1880 the

observatory records mention that Dover had "nearly completed" a "dip instrument," and, as no. 187, the instrument was soon in use at Greenwich and was in use (elsewhere) as late as 1914. It is assumed that Dover had made such instruments earlier, although surely not 186 of them! The numbers were probably coded. It has been reported that Dover's son, A. W. Dover, customarily added his initials to instruments of his own manufacture, although this has not been found on any of the instruments in the present collection. This type of circle became the most common in the United States in the late 19th century.



FIGURE 64.—Nos. 10 and 35, Magnetometer (left) and Dip Circle (right), Brunner-Chasselon, ca. 1884.

These examples of instruments used in the French Magnetic Survey in

the later 19th century, acquired by the Coast Survey about 1900, are also shown in Figures 38 and 61, where they are described.

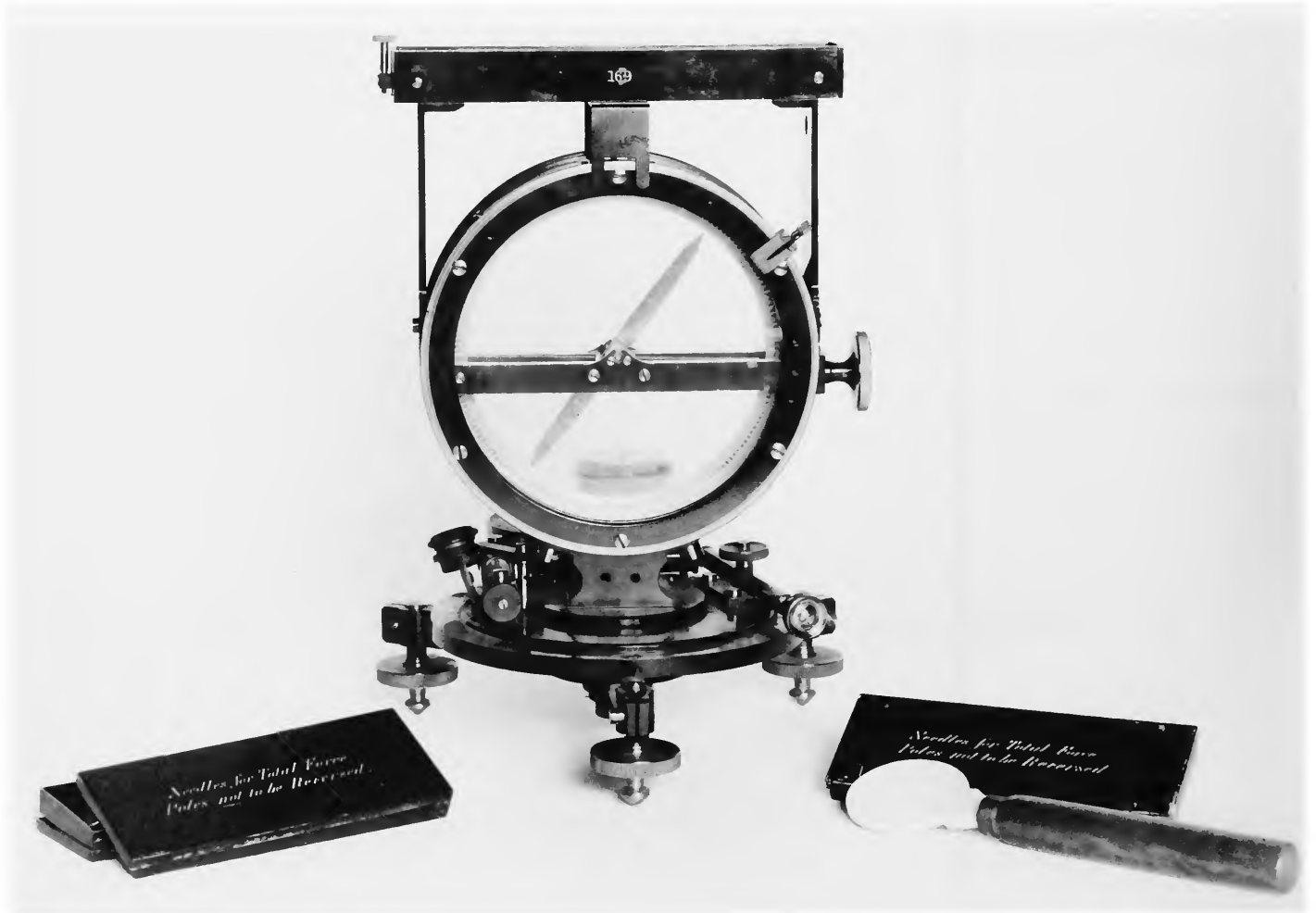

FIGURE 65.—No. 37, Dip Circle, Lloyd-Creak, Dover 168, ca. 1900.

The Fox dip circle (see text) had been modified for observation at sea in 1839. Captain Ettrick Creak, long Superintendent of the Compass Department of the British Admiralty, undertook the improvement of the instrument, after an Arctic voyage of 1875–1876, the result being this instrument. The circle is  $5\frac{7}{8}$  in/15 cm in diameter.

This example was made by Dover, and was referred to by an American source as “new” in 1901. It embodies Lloyd’s total intensity method (see Figure 62), and was further modified by E.G. Fischer at the Coast Survey, to improve its performance near the magnetic equator where the earth’s

field was overpowered by the deflecting magnet. The latter was moved further away, a trough compass was laid across the top of the instrument, and a small telescope was added for use on shore. With these improvements the instrument was rated accurate within one minute of arc, compared to ten minutes for the unmodified instrument. Lloyd-Creak instruments were used on the Coast Survey ships *Patterson*, *Bache*, and *Explorer*, and on the Carnegie Institution’s *Galilee*. This particular instrument was used in Newfoundland and Greenland in 1907–1908, and remained in use until 1911. [Reference: CIW, *Land Magnetic Observations*, volume 1, pages 46, 47.]



FIGURE 66.—Magnetic observations at sea, aboard the ship *Bache* off Puerto Rico, 1904. The dip circle in use is similar to the Lloyd-Creak instrument in the present collection (No. 37, Figure 65).



FIGURE 67.—No. 41, Dip Circle, Hotchkiss, 1929.

Patented in 1929, by W.O. Hotchkiss, later President of the Michigan College of Mining, this instrument was intended to improve on the standard dip circle, particularly as regards sensitivity, for the use of mineral prospectors and economic geologists.

Like the Lloyd instrument (Figure 18) and that of Schmidt (No. 21, Figure 51), this one depends upon balancing the force of gravity against magnetic force. A magnetized needle turns on a horizontal steel axle in the

magnetic meridian. Fastened to the magnet is a counter-arm carrying a movable weight. In use, the relative angular positions of these elements enables the user to calculate the total magnetic intensity.

[References: J.A. Fleming, *Terrestrial Magnetism and Electricity*. N.Y.: McGraw Hill, 1939, page 127. Noel H. Stearn, "Practical geomagnetic exploration with the Hotchkiss superdip," reprint, without source identification, in the museum's Division of Physical Sciences.]



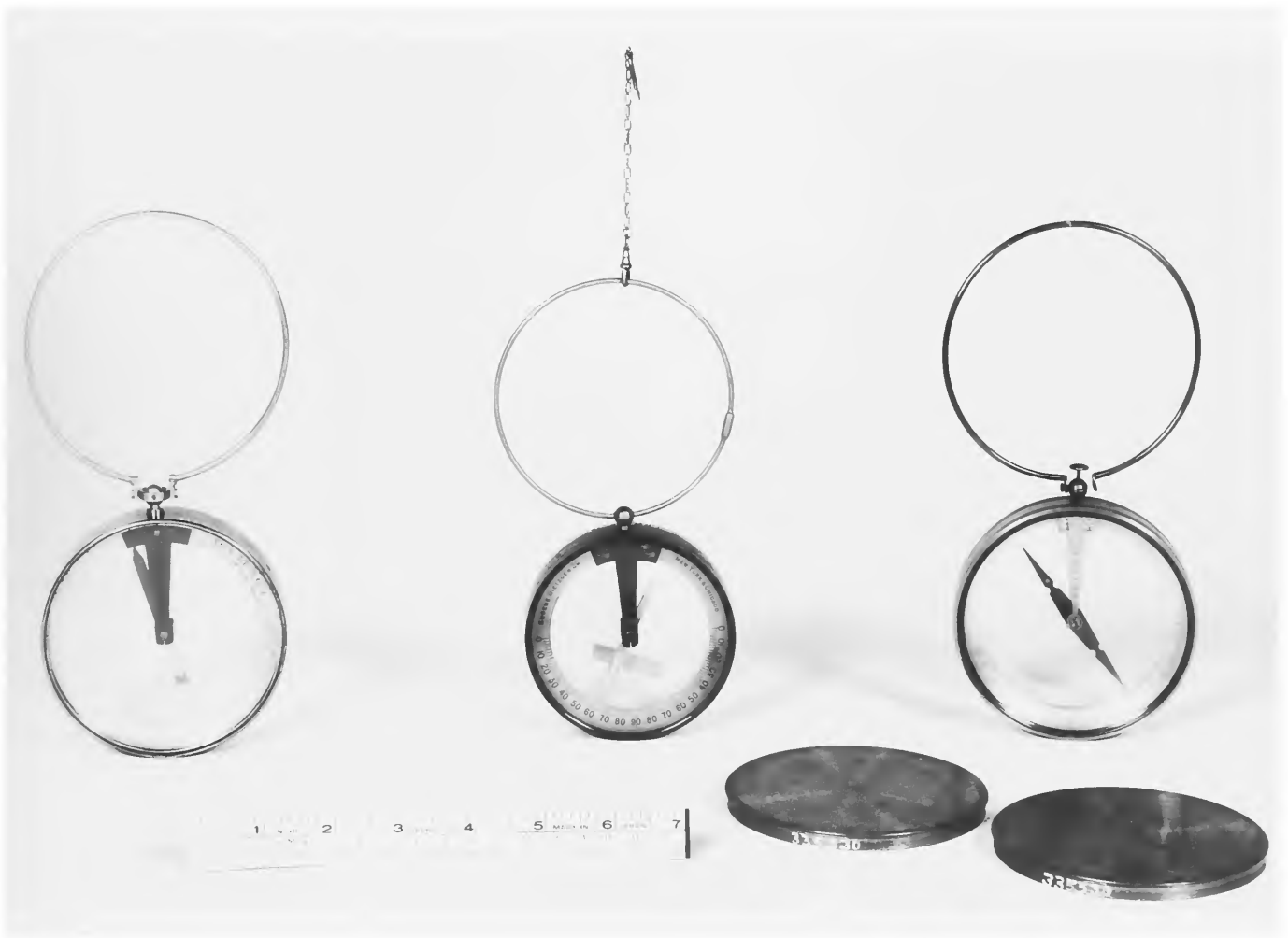

FIGURE 68.—Nos. 42, 43, 44, Propector's Dipping Needles.

These are commercial instruments sold in the United States. The W. & L. E. Gurley instrument on the right (No. 42) may be from the late 19th century, as may that on the left (No. 44), made by Keuffel & Essor, and

used by Charles Batchelor (1845–1910), an early associate of Edison in the installation of electric power systems. The instrument in the center (No. 43), made by the Eugene Dietzgen Co., is from the twentieth century. Their catalogue for 1902–1903 lists this at twelve dollars.

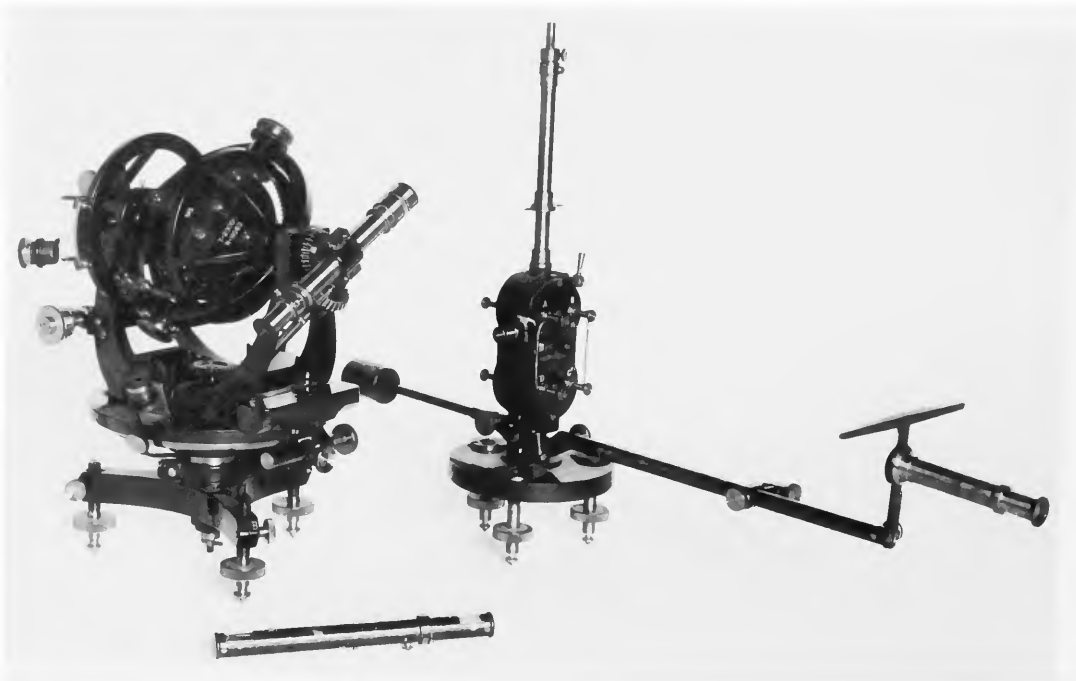

FIGURE 69 (facing page, top).—Nos. 45, 46, Dip Circles.

These instruments, more elaborate than those shown in Figure 68, appear to be for classroom demonstration. The instrument on the left (no. 46) was made by Queen of Philadelphia. That on the right (no. 45) is unmarked. It carries, on the same axis as the (cylindrical) magnet, a needle which can be set at various points on a scaled sector. Both instruments were probably made in the 20th century.

FIGURE 70 (facing page, bottom).—No. 47, Earth Inductor, Marine, CIW, 1912.

Marine earth inductors represented a major advance in instrumentation, both in terms of accuracy and ease of use. This one was developed at the DTM and was installed on the non-magnetic ship, *Carnegie*. The coil is 3 in/7.6 cm in diameter. It proved to be so superior to the Lloyd-Creak dip circles that it continued in use on cruises two through five of the ship, circumnavigating the globe several times. It was also used as the standard inclinometer at Carnegie shore stations. The galvanometer shown with it is the type used for land observation. At sea it was used with an Eintoven string galvanometer.

[Reference: CIW, *Ocean Magnetic and Electrical Observations 1915–21*. (Washington, 1922, pages 24ff.)]

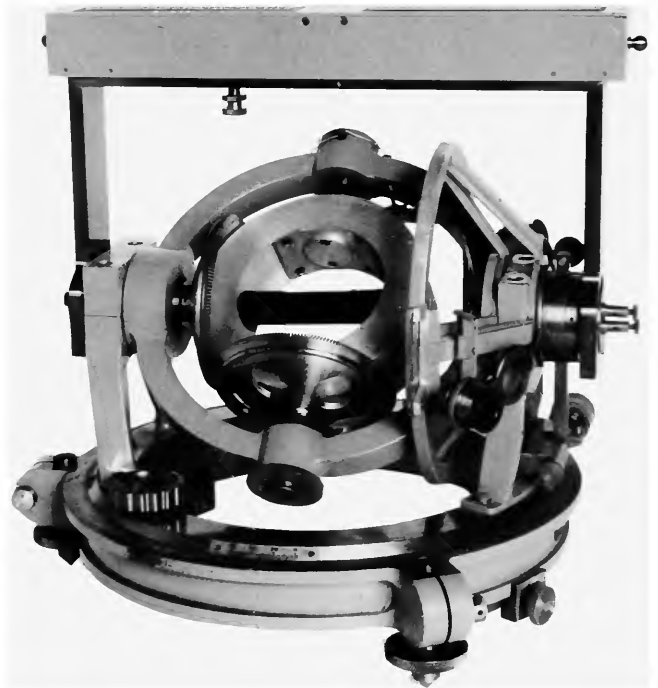

FIGURE 71.—No. 48, Earth Inductor, CS 8, ca. 1950.

This is the only earth inductor in the collection that was built expressly for permanent installation. It differs from others included herein mainly in its size and weight, which gave it increased stability and accuracy. The coil is 4 $\frac{7}{8}$  in/11.7 cm in diameter. It was built by the staff of the U.S. Naval Observatory instrument shop, apparently for the Coast Survey, which installed it at the magnetic observatory in Sitka, Alaska in 1951.

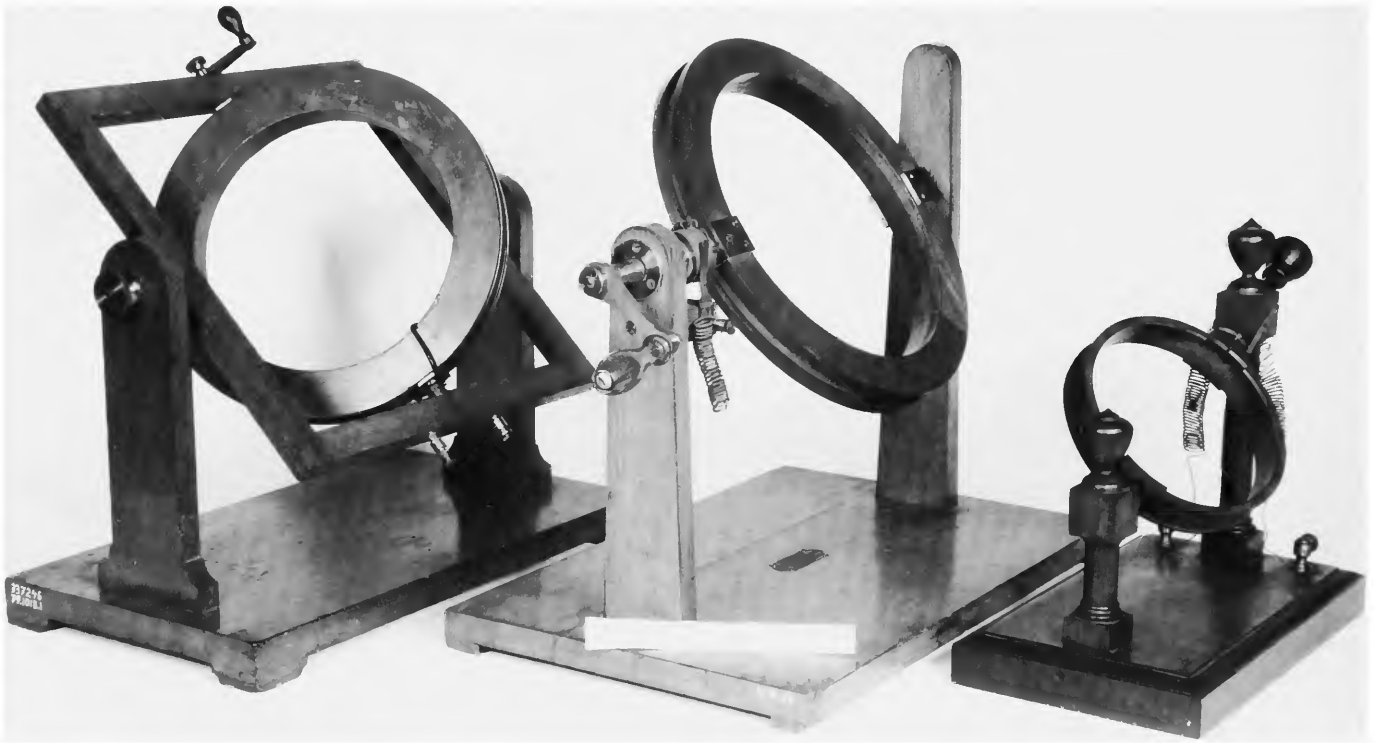
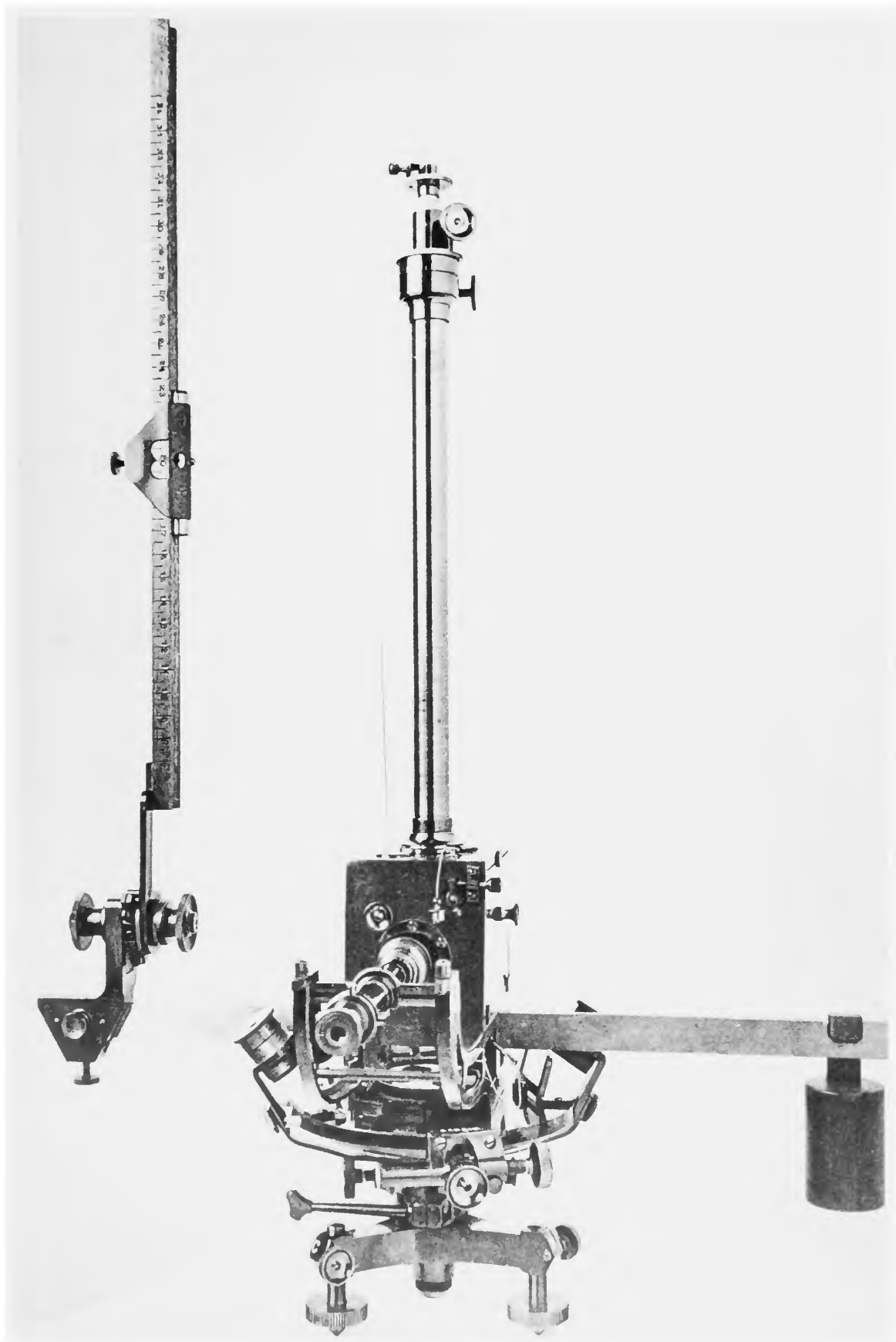

FIGURE 72.—Nos. 49, 50, 51, Earth Inductors, demonstration.

These are typical instruments for classroom demonstration. That on the left (No. 49) was made by Jas. W. Queen of Philadelphia and used at Franklin College, Franklin, Indiana. The center instrument (No. 50) was made by Max Kohl of Chemnitz, Germany, and used at Trinity College, Hartford, Connecticut. The right-hand instrument (No. 51) used at Princeton University, is unmarked and probably the only one of the three made in the 19th century.

FIGURE 73 (facing page).—No. 54, Induction Apparatus, Lamont.

This apparatus, for the calibration of magnetometers, is shown here (to the left) mounted on a magnetometer. When a magnet is placed in a magnetic field, such as that of the earth, its magnetic moment is increased or decreased temporarily by magnetic induction in an amount that is proportional to that component of the field directed parallel to the magnetic axis of the magnet. The ratio of the change produced by unit-field to the original magnetic moment of the magnet is called the induction-coefficient of the magnet. Shown here is apparatus developed by Lamont for its measurement, although this example dates from the early 20th century. The instrument is of brass, 18.5 in/47 cm. long.



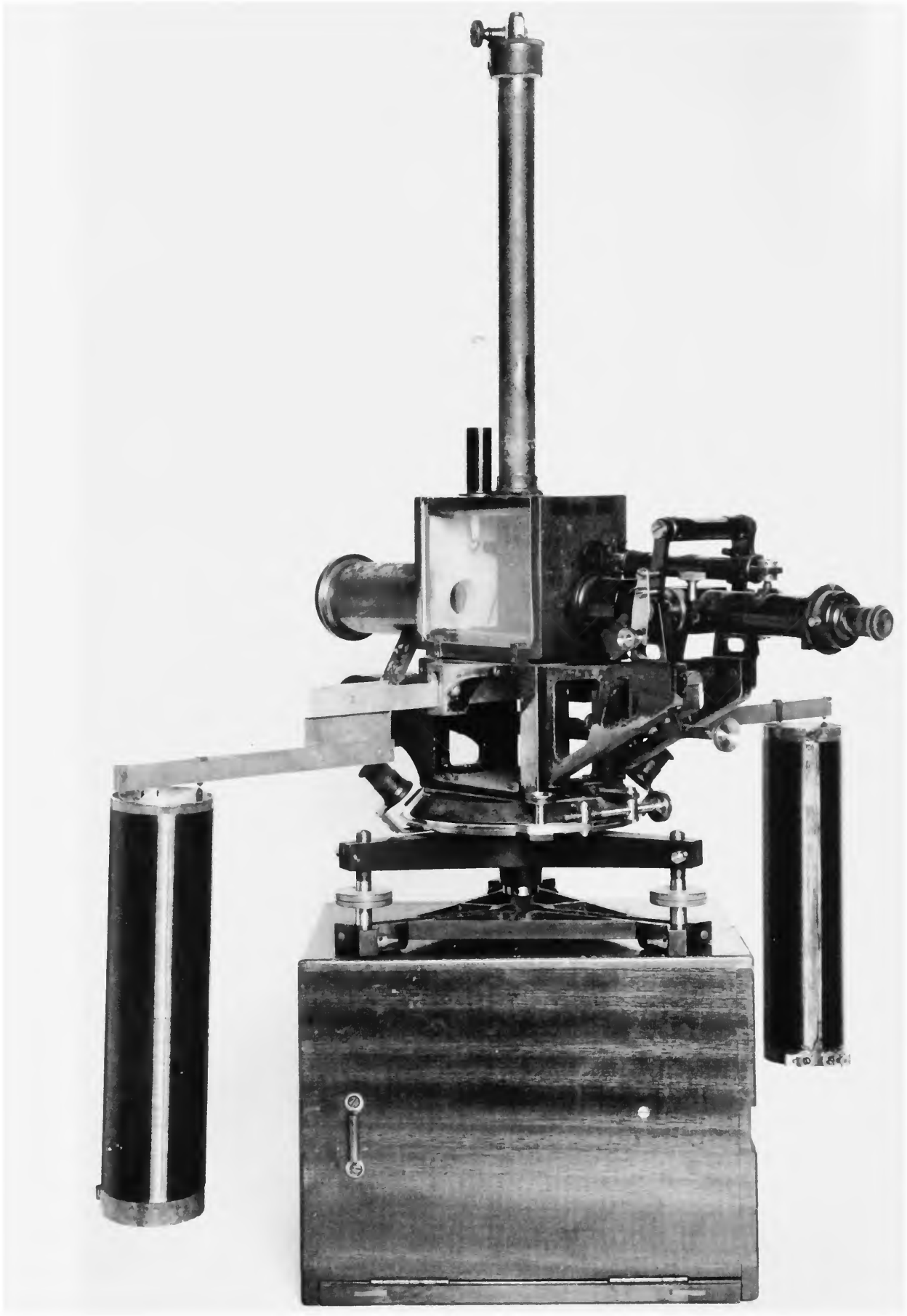

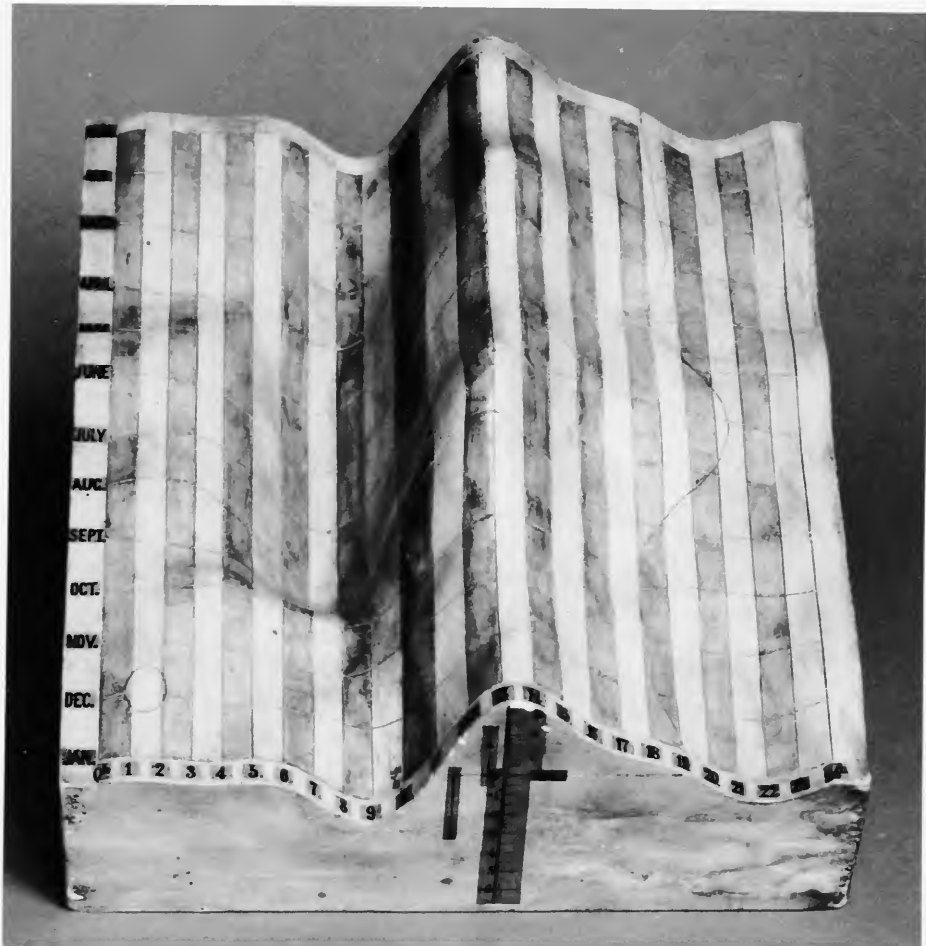

FIGURE 74 (facing page).—No. 55, Nelson Magnetic Induction Apparatus.

This apparatus, developed by J.H. Nelson in 1938, is shown with the Coast Survey's India Survey pattern magnetometer (No. 21, Figure 50). It was used at the U.S. "Standards Observatory" at Cheltenham, Md. Like the Lamont apparatus (No. 54, Figure 73), which it replaced, its purpose is to measure the "induction-coefficient." Whereas the Lamont apparatus relied on conventional permanent magnets to produce an auxiliary field, in Nelson's apparatus a precisely regulated current is passed through the hanging coils (9 in/23 cm long) creating a weak magnetic field.

FIGURE 75.—No. 56, Model of Terrestrial Magnetic Plot, 1862.

This plaster model represents in three dimensions the variation of declination with the hour of the day and the month of the year, on the basis of data collected by A.D. Bache from 1840 to 1845 in Pennsylvania. The elevated areas, as at 13 hours through all the months, indicate periods when the needle pointed west of the average position—the average position being indicated by the circle in the lower left and the curved line on the right. The needle was east of this position between the hours of about 20 and 10, as is represented by the depressions. The most marked daily variation of the needle's position is seen to have occurred in August.

The model was made by Ferdinand Engel of the Coast Survey, to accompany Bache's report on the results of the magnetic observatory at Girard College, Philadelphia.





## REQUIREMENTS FOR SMITHSONIAN SERIES PUBLICATION

**Manuscripts** intended for series publication receive substantive review (conducted by their originating Smithsonian museums or offices) and are submitted to the Smithsonian Institution Press with Form SI-36, which must show the approval of the appropriate authority designated by the sponsoring organizational unit. Requests for special treatment—use of color, foldouts, case-bound covers, etc.—require, on the same form, the added approval of the sponsoring authority.

**Review** of manuscripts and art by the Press for requirements of series format and style, completeness and clarity of copy, and arrangement of all material, as outlined below, will govern, within the judgment of the Press, acceptance or rejection of manuscripts and art.

**Copy** must be prepared on typewriter or word processor, double-spaced, on one side of standard white bond paper (not erasable), with 1¼" margins, submitted as ribbon copy (not carbon or xerox), in loose sheets (not stapled or bound), and accompanied by original art. Minimum acceptable length is 30 pages.

**Front matter** (preceding the text) should include: **title page** with only title and author and no other information, **abstract page** with author, title, series, etc., following the established format; table of **contents** with indents reflecting the hierarchy of heads in the paper; also, **foreword** and/or **preface**, if appropriate.

**First page of text** should carry the title and author at the top of the page; **second page** should have only the author's name and professional mailing address, to be used as an unnumbered footnote on the first page of printed text.

**Center heads** of whatever level should be typed with initial caps of major words, with extra space above and below the head, but no other preparation (such as all caps or underline, except for the underline necessary for generic and specific epithets). Run-in paragraph heads should use period/dashes or colons as necessary.

**Tabulations** within text (lists of data, often in parallel columns) can be typed on the text page where they occur, but they should not contain rules or numbered table captions.

**Formal tables** (numbered, with captions, boxheads, stubs, rules) should be submitted as carefully typed, double-spaced copy separate from the text; they will be typeset unless otherwise requested. If camera-copy use is anticipated, do not draw rules on manuscript copy.

**Taxonomic keys** in natural history papers should use the aligned-couplet form for zoology and may use the multi-level indent form for botany. If cross referencing is required between key and text, do not include page references within the key, but number the keyed-out taxa, using the same numbers with their corresponding heads in the text.

**Synonymy** in zoology must use the short form (taxon, author, year:page), with full reference at the end of the paper under "Literature Cited." For botany, the long form (taxon, author, abbreviated journal or book title, volume, page, year, with no reference in "Literature Cited") is optional.

**Text-reference system** (author, year:page used within the text, with full citation in "Literature Cited" at the end of the text) must be used in place of bibliographic footnotes in all Contributions Series and is strongly recommended in the Studies Series: "(Jones, 1910:122)" or "... Jones (1910:122)." If bibliographic

footnotes are required, use the short form (author, brief title, page) with the full citation in the bibliography.

**Footnotes**, when few in number, whether annotative or bibliographic, should be typed on separate sheets and inserted immediately after the text pages on which the references occur. Extensive notes must be gathered together and placed at the end of the text in a notes section.

**Bibliography**, depending upon use, is termed "Literature Cited," "References," or "Bibliography." Spell out titles of books, articles, journals, and monographic series. For book and article titles use sentence-style capitalization according to the rules of the language employed (exception: capitalize all major words in English). For journal and series titles, capitalize the initial word and all subsequent words except articles, conjunctions, and prepositions. Transliterate languages that use a non-Roman alphabet according to the Library of Congress system. Underline (for italics) titles of journals and series and titles of books that are not part of a series. Use the parentheses/colon system for volume (number): pagination: "10(2):5-9." For alignment and arrangement of elements, follow the format of recent publications in the series for which the manuscript is intended. Guidelines for preparing bibliography may be secured from Series Section, SI Press.

**Legends** for illustrations must be submitted at the end of the manuscript, with as many legends typed, double-spaced, to a page as convenient.

**Illustrations** must be submitted as original art (not copies) accompanying, but separate from, the manuscript. Guidelines for preparing art may be secured from Series Section, SI Press. All types of illustrations (photographs, line drawings, maps, etc.) may be intermixed throughout the printed text. They should be termed **Figures** and should be numbered consecutively as they will appear in the monograph. If several illustrations are treated as components of a single composite figure, they should be designated by lowercase italic letters on the illustration; also, in the legend and in text references the italic letters (underlined in copy) should be used: "Figure 9<sub>b</sub>." Illustrations that are intended to follow the printed text may be termed **Plates**, and any components should be similarly lettered and referenced: "Plate 9<sub>b</sub>." Keys to any symbols within an illustration should appear on the art rather than in the legend.

**Some points of style:** Do not use periods after such abbreviations as "mm, ft, USNM, NNE." Spell out numbers "one" through "nine" in expository text, but use digits in all other cases if possible. Use of the metric system of measurement is preferable; where use of the English system is unavoidable, supply metric equivalents in parentheses. Use the decimal system for precise measurements and relationships, common fractions for approximations. Use day/month/year sequence for dates: "9 April 1976." For months in tabular listings or data sections, use three-letter abbreviations with no periods: "Jan, Mar, Jun," etc. Omit space between initials of a personal name: "J.B. Jones."

**Arrange and paginate sequentially every sheet of manuscript** in the following order: (1) title page, (2) abstract, (3) contents, (4) foreword and/or preface, (5) text, (6) appendixes, (7) notes section, (8) glossary, (9) bibliography, (10) legends, (11) tables. Index copy may be submitted at page proof stage, but plans for an index should be indicated when manuscript is submitted.

SMITHSONIAN INSTITUTION LIBRARIES



3 9088 00725 8569

52

47



