

PARIS SCALE
FRENCH GLOVE FITTING
TAILOR SYSTEM OF
DRESS CUTTING
BY EXACT MEASURE.

Cutting a Fashionable Fit

Claudia B. Kidwell

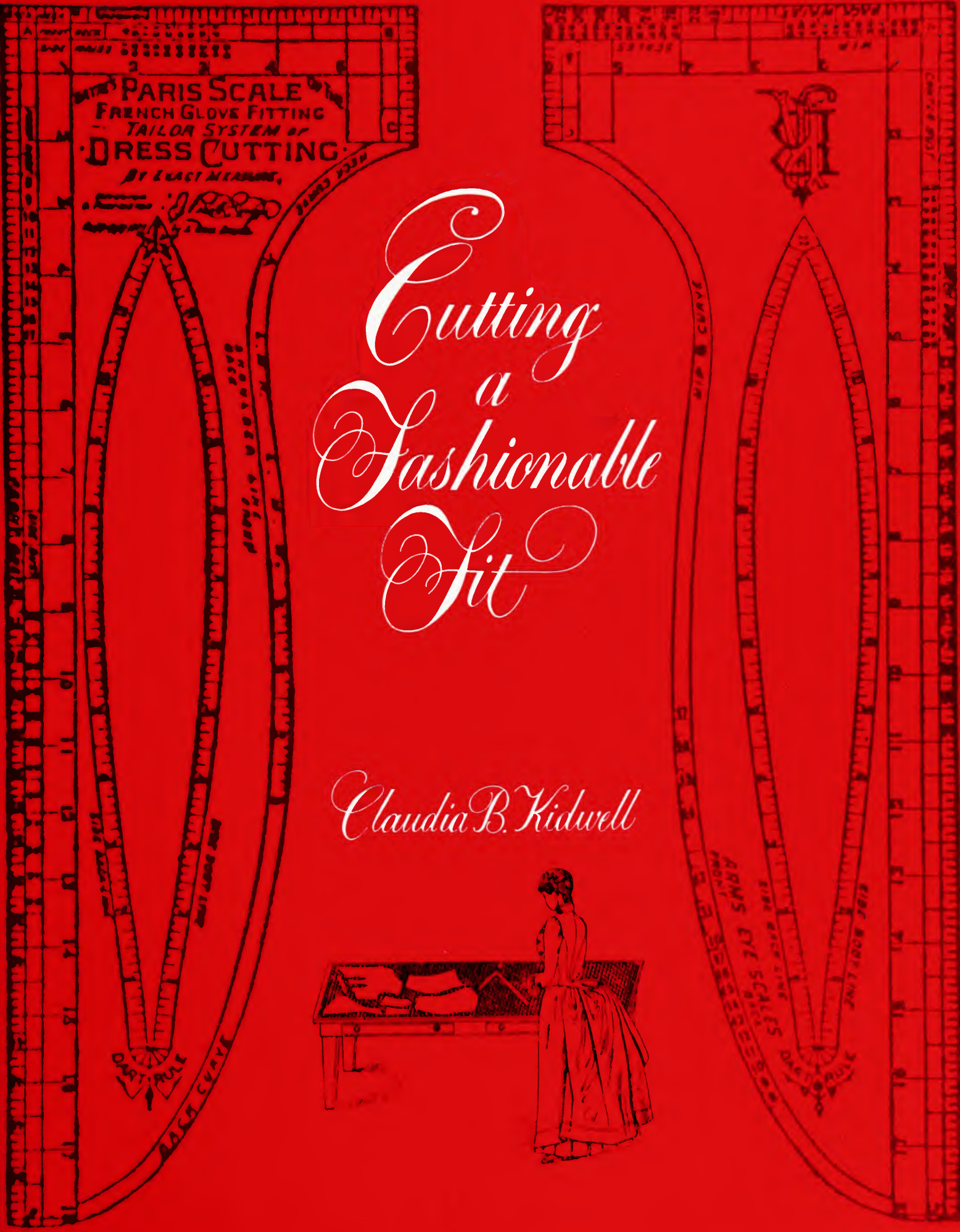

SERIES PUBLICATIONS OF THE SMITHSONIAN INSTITUTION

Emphasis upon publication as a means of "diffusing knowledge" was expressed by the first Secretary of the Smithsonian. In his formal plan for the Institution, Joseph Henry outlined a program that included the following statement: "It is proposed to publish a series of reports, giving an account of the new discoveries in science, and of the changes made from year to year in all branches of knowledge." This theme of basic research has been adhered to through the years by thousands of titles issued in series publications under the Smithsonian imprint, commencing with *Smithsonian Contributions to Knowledge* in 1848 and continuing with the following active series:

Smithsonian Contributions to Anthropology
Smithsonian Contributions to Astrophysics
Smithsonian Contributions to Botany
Smithsonian Contributions to the Earth Sciences
Smithsonian Contributions to the Marine Sciences
Smithsonian Contributions to Paleobiology
Smithsonian Contributions to Zoology
Smithsonian Studies in Air and Space
Smithsonian Studies in History and Technology

In these series, the Institution publishes small papers and full-scale monographs that report the research and collections of its various museums and bureaux or of professional colleagues in the world of science and scholarship. The publications are distributed by mailing lists to libraries, universities, and similar institutions throughout the world.

Papers or monographs submitted for series publication are received by the Smithsonian Institution Press, subject to its own review for format and style, only through departments of the various Smithsonian museums or bureaux, where the manuscripts are given substantive review. Press requirements for manuscript and art preparation are outlined on the inside back cover.

S. Dillon Ripley
Secretary
Smithsonian Institution

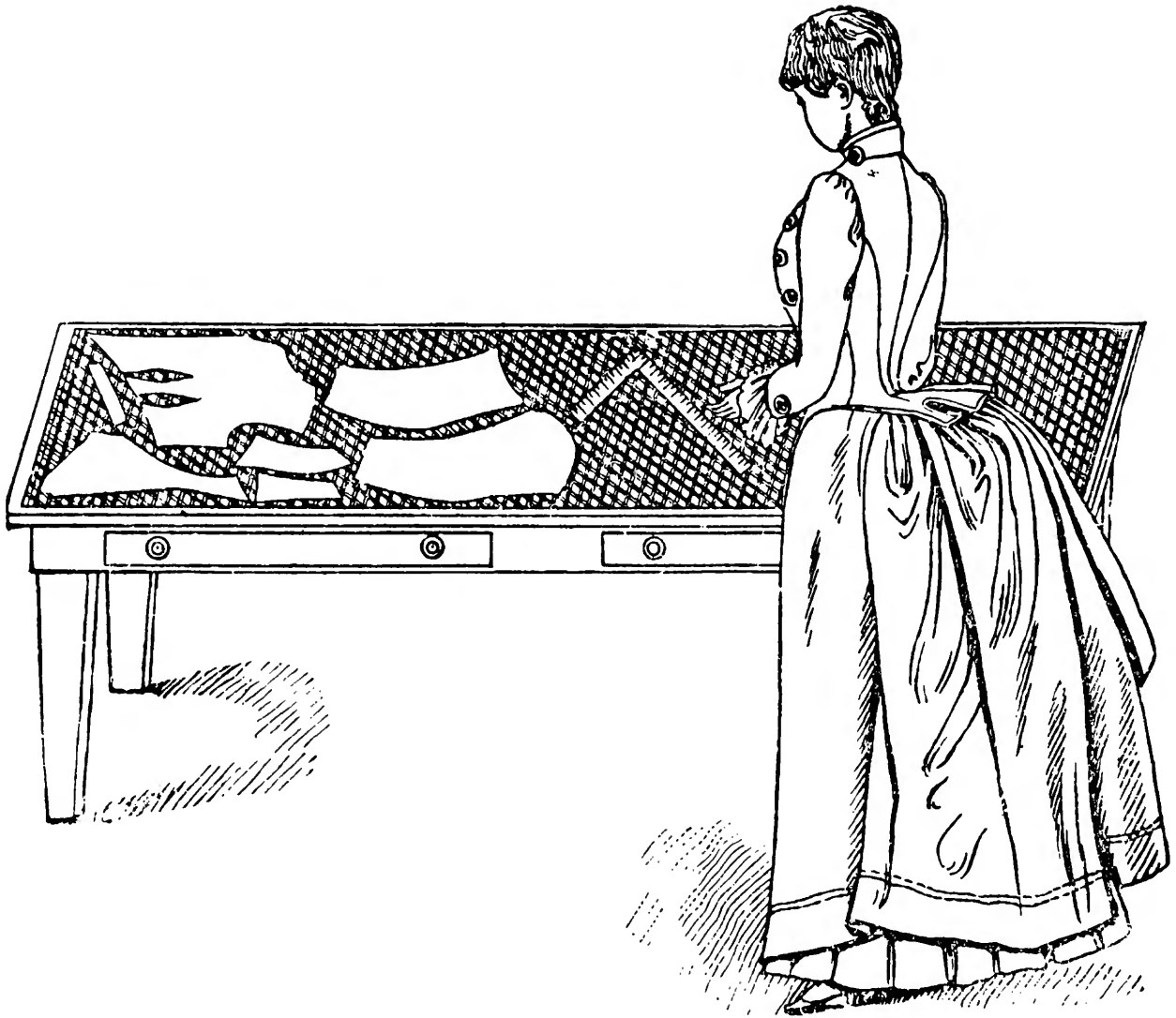

FRONTISPIECE. Drafting a bodice to measure, from Charles Hecklinger's 1886 text book subtitled *How to Cut and Make Ladies' Garments*. (Library of Congress.)

*"To that great army of Bread-Winners who fashion their own garments,
as well as those of others, this book is respectfully dedicated."
— Mallison, 1886.*

*Cutting
a Fashionable Fit*

**DRESSMAKERS'
DRAFTING SYSTEMS
IN THE
UNITED STATES**

Claudia B. Kidwell



Smithsonian Institution Press

City of Washington

1979

ABSTRACT

Kidwell, Claudia B. Cutting a Fashionable Fit: Dressmakers' Drafting Systems in the United States. *Smithsonian Studies in History and Technology*, number 42, 163 pages, 70 figures, 4 tables, 1979.—The first dressmakers' drafting system was created in the United States before 1838. This innovation provided a tool to draft stylish, fitted garments and appealed to women who were forced to make their own clothes. The concept behind the first generation of drafting systems was used as the basis for the sizing systems in the paper pattern industry and the women's ready-made clothing industry. In the last quarter of the 19th century, hundreds of drafting systems were invented to help the professional dressmaker cut the complex patterns of the fashionable dress of the period. A wide variety of changing economic, social, and technological factors determined the methods that were created at specific times, how the systems were sold, and who used them. Dressmakers' drafting systems with specialized tools became obsolete in the 20th century after simpler, less fitted dress styles became popular. These less complicated fashions encouraged the widespread acceptance of ready-made clothes and the use of paper patterns by dressmakers and home sewers.

OFFICIAL PUBLICATION DATE is handstamped in a limited number of initial copies and is recorded in the Institution's annual report, *Smithsonian Year*.

Library of Congress Cataloging in Publication Data

Kidwell, Claudia B.

Cutting a fashionable fit.

(Smithsonian studies in history and technology ; no. 42)

Bibliography: p.

Includes index.

1. Dressmaking—Pattern design—History. I. Title. II. Series: Smithsonian Institution. Smithsonian studies in history and technology ; no. 42.

TT520.K4 646.4'3'04 78-606020

For sale by the Superintendent of Documents, U.S. Government Printing Office
Washington, D.C. 20402
Stock Number 047-000-00353-9

Contents

	<i>Page</i>
Preface	vii
Introduction	1
Before Dressmakers' Drafting Systems	3
Tailors	4
Tailors' Drafting Systems	7
Mantua-Makers	11
A 19th Century Invention	13
Earliest Evidence of Dressmakers' Drafting Systems	20
Proportional Systems	25
Hybrid Systems	31
Direct-Measure Systems	45
Squares	50
Adjustable	53
Conforming	68
Selling the Systems	74
The Users	80
Amateur Dressmakers	80
Paper Pattern Industry	81
Professional Dressmakers and Cutters	90
Ladies' Tailors	93
Ready-made Clothing Industry	94
Conclusions	98
Appendix I: Pre-1920 Publications at Library of Congress	
Containing Drafting Systems for Women's Garments	105
Chronological Index to Authors	127
Appendix II: Dressmakers' Drafting Tools at Library of Congress	129
Appendix III: Patents for Drafting Systems for Assorted Clothing	129
Index to Patentees	150
Appendix IV: Tables of Geographic Distribution	155
Literature Cited	157
Index	160

Preface

In 1968 I started the research on what I intended to be a small article discussing the importance of the late 19th century McDowell Garment Machine. My efforts were prompted as much by my interest in the manufacture of clothing as by the occasional public inquiries I had received. Typically, these letters said, "I have a McDowell Garment Drafting Machine . . . I have written several places to find out any information on this and so far no one has any information to send me, and found out you have information on about everything . . ."

Staggered by the faith some people have in the Smithsonian Institution, I hoped to be able at least to answer some of the questions raised about the popular, late-19th-century McDowell machines. The scope of my work broadened as I gradually perceived the significance of the number of instruction books at the Library of Congress and the hundreds of patents filed in the U.S. Patent Office.

As the project grew I benefitted from the association with and the assistance of Charles E. Brush as I gathered the basic data from the pre-1900 publications and patents related to drafting systems. This is but one of the many ways he has helped the National Museum of History and Technology as a volunteer. My study of the earliest patents was facilitated by the gracious assistance given by James Paulauskas, archivist in the Industrial and Social Branch of the National Archives. Anne W. Murray, curator emeritus, Division of Costume, learned of my project during this early stage and encouraged me by her belief in the value of this work.

My research, however, was interrupted several times, as my energies were diverted to other major projects. I am grateful to Rodris Roth, then supervisor in the Division of Costume and Furnishings, for encouraging me to return again and again to this study. In 1972, I thought that my work was nearly completed when I stopped again, this time to assist with the museum's bicentennial exhibits and in particular to coordinate the preparation of the exhibit "Suiting Everyone" and its related publication.

In the fall of 1976, I was able to return to my data on dressmakers' drafting systems. Facing this research after having ignored it for four years was made a little easier by the interest expressed at this time by Al Ruffin, managing editor of the Smithsonian's series publications. Getting into this material again, however, I realized that the study had to be broadened once more. I needed to extend my work another 20 years to 1919 in order to document what had happened to these systems.

To finish this work before something else intervened I relied upon the assistance of a number of individuals. I am personally grateful to the staff of the Division of Costume: Barbara Dickstein, collaborator; Karyn Harris, museum specialist; Shelly Foote, museum technician; and Valerie Goddard, secretary. By their energetic and imaginative handling of much of the ongoing as well as the unusual collecting, public service, and research activities of our division, I was

able to take the time needed to conclude this study.

As I reconsidered the relationship between tailors' systems and dressmakers' drafting techniques, I found the sources provided by Betty Kramer to be of great help. Several years earlier she had obtained for our costume library copies of the early tailors' instruction booklets at the Library of Congress. Carol Kregloh arranged the collected appendix data into the desired format and obtained the data needed for the 1900 to 1919 period. Not only did she accomplish this with a high degree of accuracy and completeness, but she contributed to this paper in many ways with her insightful observations. Dorothy Pouquet assisted with the French translations with her usual competency.

As I worked further on the manuscript, many questions came to mind concerning the relationship between innovations in the tailoring and dressmaking trades vis-à-vis other crafts and concerning the social significance associated with these technological changes. These concerns highlighted my appreciation for being a part of a museum encompassing so many varied fields. I was generously helped by Silvio Bedini, then deputy director; Anne Golovin, then associate curator of the Division of Pre-Industrial Cultural History; Howard Hoffman, museum specialist, Division of Naval History; Peter Marzio, then curator, Division of Graphic Arts; Edith Mayo, assistant curator, Division of Political History; Uta Merzbach, then mathematician, the Section of Mathematics; and Robert Vogel, curator, Division of Mechanical and Civil Engineering. I am especially grateful for the assistance of John Hoffman, curator in charge of the Warshaw Collection of Business Americana of the National Museum of History and Technology. I also benefitted from the good advice of Bob Post who graciously read the manuscript at various stages.

I am grateful to Sydney Brooks, theatrical costume designer, for loaning for study two sets of drafting tools from her collection. I am also most appreciative of the opportunities I have had to examine the resources in the Butterick Patterns Archives/Library. Illustrated items noted as belonging to the Smithsonian Institution are in the collections of the Division of Costume unless otherwise specified.

In the last months of my work, Nancy Martin, Lynne Conlee, and Priscilla Bloom served as volunteer research assistants as they helped me track down the answers to some last minute questions. Nearing the end of the project, I was gratified by the interest and extra concern for accuracy exercised by Lynne Conlee and Valerie Goddard as they typed the final manuscript. Also, I am most appreciative of the contributions of Edna Luginbuhl who drew the bar graphs to illustrate some of my conclusions.

Adele Filene, researcher and writer, studied this manuscript closely in its final form. It was possible to take into account some of her suggestions even though this paper was "in press." I am most grateful to have had this opportunity to benefit from her considerable knowledge of couture dressmaking technique and mass production drafting procedures acquired from her exceptional experience in Germany and England.

Throughout the final stages, the Smithsonian Press was most helpful. Al Ruffin's continued interest was gratifying. Barbara Spann applied her editorial skills as well as her particular expertise in the subject matter to make this paper more readable and precise. Stephen Kraft in addition to designing the book supplied the creative art work for the cover.

Cutting a Fashionable Fit

DRESSMAKERS' DRAFTING SYSTEMS IN THE UNITED STATES

Claudia B. Kidwell

Introduction

In the 19th century, dressmakers' drafting systems were heralded as a solution to the plight of downtrodden working women. A writer in 1885 described them as "the wings which will waft the sewing woman from the gloom and despondency of an over-wrought and under-paid laborer to the dignity and independence always the due of patient, persistent industry" (Cornwell, 1885:20). Yet, in less than 90 years since the period of their greatest popularity, these drafting systems are all but forgotten. Today, 19th century drafting tools that were once touted as "magical devices" are seldom even recognized for what they are. If they are identified, they are generally dismissed as merely another of those gadgets of which 19th century Americans were so fond.

Drafting systems were, nevertheless, a significant technological and economic breakthrough. They reduced the amount of time and skill required to cut a fashionable garment that fit well. Amateur

home sewers could produce better garments for themselves and their families. Aspiring dressmakers with little training could make salable clothing. And experienced professional dressmakers could improve their business by reducing cutting errors and fitting time. Nineteenth century drafting systems with specialized tools enabled every maker of dresses to cut a fashionable fit.

The creators of these devices contributed to the democratization of clothing.¹ The final result was not, however, what they intended. Drafting systems became the basis for the sizing systems of the paper pattern industry and the ready-to-wear industry. The success of these industries gave the majority of Americans the opportunity to be fashionably dressed in clothes that fit. It also diminished the importance of the custom dressmaking trade.

This paper is not an exhaustive treatise on dressmakers' drafting systems. The evidence is not

Claudia B. Kidwell, Department of Cultural History, National Museum of History and Technology, Smithsonian Institution, Washington, D.C. 20560.

¹See Kidwell and Christman (1974) for a general discussion of the many factors that contributed to the democratization of clothing in America.

sufficient for that kind of study. Dressmaking was usually an anonymous occupation carried on by individuals working in a limited area. Rarely was the work of these women recorded in print. Their trade depended for the most part upon word of mouth recommendations. Unlike popular women's magazines such as *Godey's Lady's Book*, which can be found in many libraries, the more specialized American periodicals for dressmakers have largely disappeared. The fate of S. T. Taylor's *Le Bon Ton* is typical: it was published as early as 1857 and as late as 1919, but in spite of its longevity, extant issues are rare. This is a common phenomenon that inhibits any investigation concerning 19th century dressmaking techniques.

Instead of attempting to be an exhaustive discussion of drafting tools, this paper is a general overview intended to accomplish three purposes. First of all, there is exposition of the theme that dressmakers' drafting tools were a product of their time. A long tradition of tailoring and "mantua-making" preceded the creation of drafting systems. Tailors were first provoked by economic exigencies into creating efficient, systematic methods for their own use—probably in the late 18th century. Roughly 40 years later the conditions existed to foster dressmakers' drafting techniques. A wide variety of changing economic, social, and technological factors determined the methods created at specific times, the manner of selling the systems, and the composition of the market for them. Circumstances as disparate as the economic opportunities open to women and the limited availability of inch tape measures in the first half of the 19th century had an impact. (I was surprised to discover the major extent to which dress fashions affected the growth of clothing related industries.)

The second purpose is to provide the reader with the knowledge necessary for identifying systems other than those discussed here. Nineteenth century drafting systems for both tailors and dressmakers were based on proportional, hybrid, or direct-measure principles. Unlike tailors' methods which often did not require unique drafting tools, dressmakers' drafting systems usually depended upon highly specialized devices. This difference is explained by the disparate levels of skill and experience on the part of the presumed users. Techniques for cutting men's suits were created for professional tailors. No suggestion was ever

made that a man not engaged in this trade could use such a system to cut his own clothes. Dressmakers' systems, on the other hand, were initially intended for the amateur's use in making apparel for herself and her family. Even in the late 19th century, when these techniques were most frequently created for professionals, the users, whether professional or amateur were still women. As a whole, women were neither as well educated as men nor were they thought capable of assimilating as much knowledge. For all of these reasons tools designed to simplify the drafting process were considered essential for the majority of amateur and professional dressmakers, the vast majority of whom in the first half of the 19th century were women.

Dressmakers' drafting tools existed in great variety. They were manufactured in diverse forms, out of various materials. They were made of paper, cardboard, wood, metal, or some combination of these. They were in the form of nearly square rectangles, rectangular strips, squares (similar to a carpenter's square), irregular curves, or a composite of forms. They could be perforated, adjustable, and/or conforming. Some used apportioning scales, some distributed circumferential dimensions by other means. The systems discussed in this paper were selected to demonstrate how the three drafting principles were applied and to suggest the variety of tools that were made.

The third purpose is to encourage research on drafting systems and related industries by providing previously unpublished compilation of data such as the appendices listing the instruction booklets at the Library of Congress and relevant U.S. patents. Instruction booklets for dressmaking systems are the most important resource for information about these techniques. These booklets were usually published by the author with a limited printing. And, because of the local distribution of the majority of these works, many are now rare or known only through secondary sources. Probably many have disappeared without a trace. It may be years before all of the extant examples of these obscure publications can be found, examined, and evaluated.² Because of its role in the copyright

² Ms. Pat Trautman, assistant professor and curator, Historic Costume and Textile Collection, Colorado State University, is working on a locator index for dressmakers' drafting tools and instruction booklets. She would like to hear from individuals who have relevant items.

process, the Library of Congress holds the largest known collection of these booklets.

Patent drawings and specifications are almost as important as the instruction booklets. Patent drawings showing a tool are especially important when the device is not extant and when the booklet does not illustrate it. The patents provide a fuller history of the development of some systems than is revealed in any other source. And when instructions do not accompany an extant tool, the patent may provide information concerning the drafting process. Of course, many tools that were manufactured were not patented and many that were patented were never manufactured. The numbers of individuals who applied for patents and their varied locations do, however, reflect the widespread creative effort that was underway.

The fashion terminology of the era covered by this paper is sometimes confusing. “Bodice,” “waist,” “basque,” and “polonaise” are but a few of the terms that have been used at one time or another in the general sense of designating the upper part of a dress as opposed to the lower part, the skirt. Some of these terms have more specifically indicated a particular style for this portion of a dress. For example, the term “basque” was sometimes used in the 1870s and 1880s to refer to a bodice or “waist” that extended several inches below the waistline to fit smoothly over the hips on top of the skirt. Occasionally “basque” denoted simply the extension itself. Certainly this appendage added to the difficulties of cutting a bodice of the period—making the “basque” a garment to remember by name.

Before Dressmakers’ Drafting Systems

Since the time man first began to wear shaped garments made of more than one piece of material, he has been faced with two tasks—forming the separate pieces of the garment and sewing them together. As garments became more elaborate and as fashion requirements for a specific line became more exacting, greater skill was required for both tasks. Of the two, cutting was by far the more difficult. “Cutting” the parts of a garment historically refers to the mental process of determining the shape of the pieces as well as the physical act of cutting.³ In 1807, *The Book of Trades* observed that to be a good cutter, an individual’s “hand and head must go together” (Johnson, 1807:73). The craftsman whose work required the greatest cutting skill was called a tailor. The Old French word “tailleur” meant literally “one that cuts.” In contrast, while sewing the seams of a garment with needle and thread might require more time than cutting, it demanded much less knowledge and training. Thus, those whose principal occupation was the relatively unskilled labor of sewing were called at various times sempsters, seamsters, sempstresses, or seamstresses.

This division of labor became institutionalized by custom and by trade guilds. Laws governing guilds protected the distinctions between the skilled craft of the cutter and the labor of the sewer. They gave tailors the exclusive right to cut garments for women as well as for men. In France, where the laws were more strict than in England, women were not permitted to make most feminine garments until 1675 (Garsault, 1769:48). This radical departure from medieval precedent occurred when Louis XIV agreed to the establishment of a separate guild for women who were to be called *mâitresses couturières*. This was the first of several laws that allowed women to produce a wider range of garments. A similar change in custom occurred at about the same time in England.

By the 18th century English women cut most of the more complicated feminine apparel, including the *mantua*,⁴ from which they took their name,

³ Throughout this paper the term “cutting” is used in the broader sense.

⁴ A *mantua* was the dress that was popular in England for most of the 18th century. In the *mantua*, the back pleats were stitched down to the waist to make the gown fit the upper torso. In contrast, the back pleats in the sack (Figure 9), also worn at the same time, were not stitched down to the waist. English women preferred the *mantua*, which led the French to distinguish between the two styles by calling the *mantua* a “robe à l’Anglaise” and the sack a “robe à l’Française” (Waugh, 1969:68-69).

“mantua-makers.” The distinctions between cutting and sewing continued. Seamsters and seamstresses were primarily sewers while master tailors and mantua-makers were the skilled workers who cut the more complicated garments.

Tailors

A 1747 *Description of All Trades* observed that for tailors “the most dextrous Part is *Cutting-out*, on which depend the Fitting and Shape, the principal Articles that give Ease and Pleasure to the Wearers, and obtain Customers; therefore a Man is not properly qualified to set up for himself who has not got a pretty good Knack at it” (Waller, 1747:206). The method for “cutting-out” was de-

ceptively simple.⁵ A tailor measured his customer with a long strip of paper or parchment, recording the pertinent dimensions by cutting notches in this strip (Figure 1). To make a suit coat the tailor noted as many as 14 measurements (Figure 2). Each cutter had his own particular way of marking his “measure,” as the notched strip was called, and thus one cutter would have found it difficult to understand another cutter’s measure.

A tailor usually kept paper patterns in different sizes to help him determine the shapes of the garment pieces (Figure 3). He developed the dimensions and the outlines of his patterns through experimentation—their form was his trade secret. These patterns were so important that in England tailors sometimes referred to them as “Gods.” Indentures sometimes stipulated that the master was to give a copy to his apprentice on the condition of strict secrecy and patterns were mentioned in wills as a significant legacy from father to son (Giles, 1887:89).

When preparing to cut a garment for a customer the tailor selected a pattern of about the right size. He laid it on the fabric and traced around it lightly with chalk. Next, using the customer’s measure he checked the dimensions of the outline, marking the necessary corrections in chalk and redrawing the draft accordingly. The tailor then cut the material.

Using the measure both to record the dimensions of a customer and to draft a garment may date from the time when units of measurement were not standardized. This would have been a useful technique when few were literate. When he had the “measure of a man,” a bright apprentice did not need to know how to read, write, or use numbers in order to learn the art of cutting. He learned to think in spatial distances rather than in measurements coded into abstract units, such as inches. Mastery of the art of cutting was achieved after years of training and experience. Cutting was an individualized intuitive art that could not be quickly communicated to another.

Only the stubborn force of tradition adequately



FIGURE 1. Tailor measuring a customer for a coat, 1736 print from unidentified source. (New York Public Library.)

⁵ This method was first described by the Frenchman M. de Garsault for “L’Art du Tailleur” in *Descriptions des Arts et Métiers*, (1769, volume 31). Garsault’s work was used by Diderot in his *Supplément à l’Encyclopédie* (1776-77). Portions of Garsault’s descriptions have been translated or paraphrased in several modern histories, e.g., Arnold (1964) and Waugh (1964, 1969).

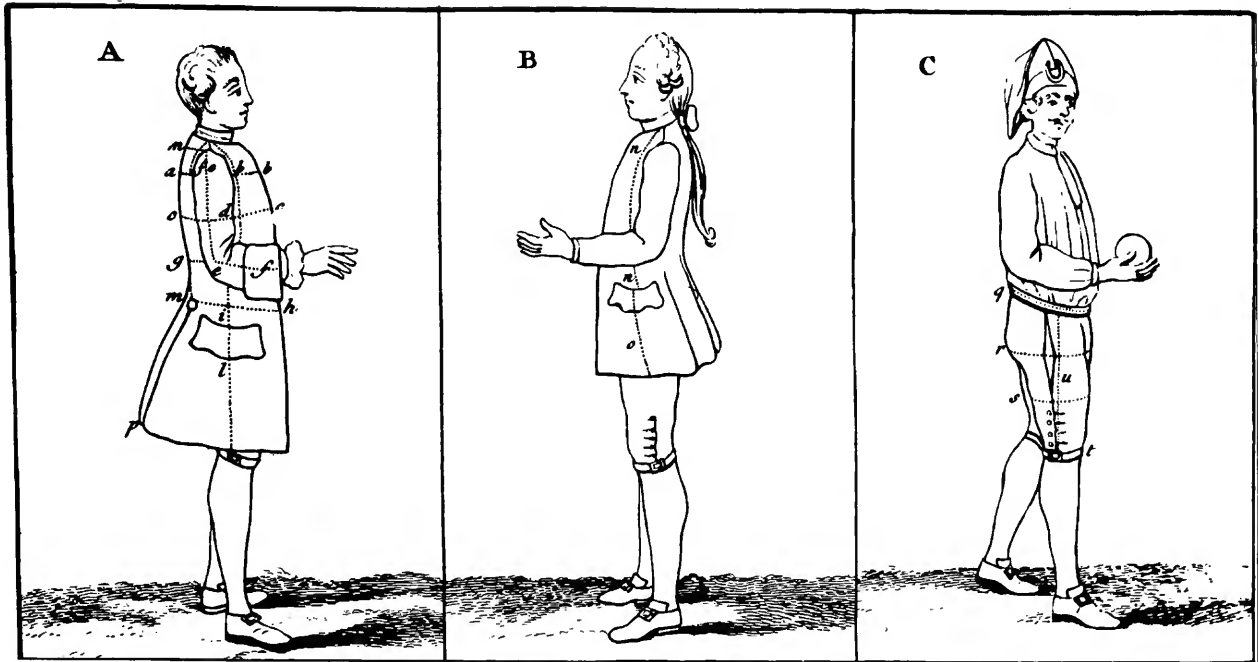

FIGURE 2. Measurements needed to draft the coat, waistcoat, and breeches of a man's suit, 1769, from Garsault, "L'Art du tailleur," plate 4. (Smithsonian Institution.)

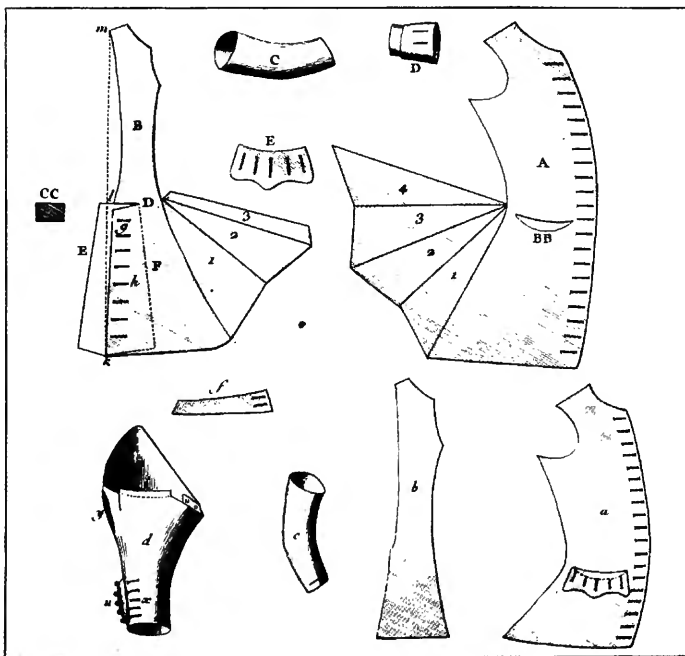

FIGURE 3. Parts of the three garments in a man's suit, from Garsault, "L'Art du tailleur," plate 5. *Coat*: A, front; B, back; C, sleeve; D, cuff; E, pocket flap; CC, reinforcement for back pleat. *Waistcoat*: a, front with pocket flap; b, back; c, sleeve. *Breeches*: d, front, e, back, f, waistband. (Smithsonian Institution.)

FIGURE 4. Man's suit, 1769, from Garsault, "L'Art du tailleur," plate 4. (Smithsonian Institution.)



explains why the notched measure was used through the end of the 18th century. This is especially remarkable as yardsticks and squares marked in inches were in general use, most noticeably by carpenters (Hummel, 1968:118, 143). As late as 1796 in England and 1809 in the United States a published drafting method required the use of the measure while following a series of directions which sometimes involved distances reported in inches (Society of Adepts, 1796, and Queen and Lapsley, 1809). The 1809 American publication even advised tailors to determine the amount of material needed for a suit coat by measuring "by your yardstick, the length of your coat, as you have taken it from your measure, to which add the length of your sleeve" (Queen and Lapsley, 1809:23). Curiously, tailors did not see any merit in translating the measure into inches, not even to record these vital statistics in their order books. Taking the measure of a man was so much a part of the art and mystery of tailoring that the mere presence of the yardstick was not enough to effect a change in practice. More powerful forces were needed to break the strength of tradition.

Throughout the 18th century the fashionable cut of men's clothing evolved slowly, mutating slightly in one feature then in another. The net result was a persistent trend toward a closer and closer fit and narrower proportions. In the last decades of the 18th century the suit coat became so fitted that even the simplest movement of the arm caused a wrinkle to appear across the front of the shoulder (Kidwell, 1976). By the early 19th century, men's suit coats had become sculptural forms created more by their cut than by the drape of the textile (Figure 5). Increasingly, a gentleman's figure was the product of his tailor's art rather than his parents' genes. The precisely cut, closely fitting fashions demanded the best efforts of skilled and experienced tailors. Some tailors found that traditional cutting methods were not adequate to meet the demands of changing fashions and the changing times.

The 18th century has been called the "Age of Enlightenment" because men regarded experience and reason as more important than divine revelation. It was this optimistic belief in the individual's ability to observe, experiment, and solve problems that fostered the inventive activity that revolutionized the production of textiles. The time was right for individuals to set aside traditional prac-



FIGURE 5. Fashionable full dress costume for gentlemen, from the April 1810 issue of the English magazine, *Ackermann's Repository of Arts*. (Courtesy of Karyn Harris.)

tices and devise new solutions to old problems. Change was in the air at the end of the century, the industrial revolution with all its ramifications was under way.

New factories drew rural populations to urban production centers. Those wanting "respectable" city clothes rather than laboring garb were increasing in number, but they could not afford the exclusive prices of traditional made-to-order work. Tailors were faced by the difficulties of cutting more closely fitted garments in line with the changing styles. At the same time, they were subjected to consumer pressures to keep their prices down. Tailors, especially those wanting to take advantage

of the new market opportunities, were in a position to welcome any new technique that would solve their cutting problems. Technological development was essential if clothing manufacture was to be shifted from custom tailoring to mass production—that is, producing for the masses.

Tailors' Drafting Systems

In 1809, Queen and Lapsley described for the benefit of other tailors a methodical utilization of the traditional measure in the producing of custom work. In their preface, however, they referred to a system that many tailors had adopted.

There are many who work by patterns, and this method of working, we are afraid, is too much followed by the Trade. There is one maxim with us, working by lengths and following nature in every existing circumstance. In which case, patterns can be of but little use to any but Slop makers, where they may have them from the smallest size up to the largest Figure, upon proportionable scales. But where Nature has sported a little with the formation of a figure, a person would look quite awkward in one of those slop made coats (1809:vi).

Note that the authors matter-of-factly said “proportionable scales” (the technique of projecting all the dimensions of a garment in proportion to one body measurement). Use of these scales was not reported as an innovation but was cited as a common practice to be abhorred by the professional custom tailor. Significantly, this citation appeared in an 1809 book published in the United States. At this time, American tailors relied upon their English counterparts for almost every innovation. Thus it is reasonable to assume that “proportionable scales” were used well before 1809 by the cheaper trade in England.

One historian, Norah Waugh, proposes that the development of proportional drafting systems was the result of the introduction of the inch tape measure. She argues that its use “drew attention to the comparative relations that exist between the various parts of the body” (Waugh, 1964:130). Singling out the tape measure as sole catalyst for this revolutionary departure from traditional methods seems to me too limited an explanation. It does not take into account the more generalized forces that could have affected the tailor’s thinking.

Tailors were not the first to consider the human body in proportional terms. In ancient Athens the human body was studied as a natural phenomenon with a proportional form that could be analyzed

and codified into geometric laws. The differences between one person and the next were overlooked by sculptors who concentrated on the representation of “ideal” forms. These were seen to be more representative of nature than the irregularities that existed in any particular individual.

Again and again artists turned away from the apparent chaos and haphazard appearances of nature to rediscover classical mathematical order. Leonardo da Vinci’s “Man of Perfect Proportion” is representative of this movement in Renaissance Italy. In the 17th century the efforts of Louis XIV in France to make the classical style official had a significant effect on French artists of the period. And in England the conservative rules of classicism continued to have great appeal in the 18th century. There, one school of academic theory, exemplified by Sir Joshua Reynolds’ *Discourses on the Fine Arts* (1769-1790), delivered before the Royal Academy in London, continued to define the essence of beauty in terms of the ideal classical forms (Marzio, 1976:26).

The discoveries at Pompeii and Herculaneum in the 1740s had a profound effect on the decorative arts throughout Europe. In the mid-18th-century “Roman ruins” initially were used merely as an alternative to “Chinese” pagodas in the romantic decorations of the period, from the motifs on printed fabrics to the reproduction of “scenic” embellishments of landscaping projects. In time, the order and simplicity of the ancient Greek and Roman sources were seen as a welcome relief to the involuted complications of the rococo designs which had overlaid the classical Renaissance heritage. By 1785, a wave of popular neoclassicism was sweeping over France and through Europe. Once again the “true” rules of human proportions were being set forth as artistic laws of nature (Marzio, 1976:38).

I do not believe that the proportional theories of artists were the initial basis of tailors’ proportional drafting systems. After all, most artistic theories dealt with two-dimensional proportions based on the length of the human head while tailors’ systems were concerned with three-dimensional proportions relative to the circumference of the “breast.” I do propose that the widely discussed “geometric” theories that were inherently a part of the neoclassical movement reinforced or made more credible the discoveries that tailors were probably making on their own.

It seems reasonable to expect a tailor, trained to think in terms of spatial distances, to notice how consistently the notches on his measure were aligned in a similar relationship to each other. Certainly he might have observed how regularly the length from neck to waist was half the man's breast measure and the chest width one-third (Waugh, 1964:130). He could have used these observations when he modified the patterns that he used as a guide to drafting garments cut with his customer's measure. The tailor who manufactured ready-made coats, however, used only his set patterns. He mass produced garments for unknown customers, hoping to fit as many as possible "from the smallest size up to the largest Figure." Even though the "slop maker's" customers could not afford to be very particular about the fit of their clothes, the tailor-entrepreneur would have had an economic interest in applying proportionate observations to the creation of his master patterns.

Waugh's reasoning concerning the significance of the tape measure may have been influenced by the fact that the first outpouring of published drafting systems (mostly of a proportional type) occurred in the early 19th century at the same time that the inch tape measure was coming into use. In my opinion this co-occurrence does not reflect a causal relationship between inch tape measures and proportional theories. Instead, I believe both developments reveal an increased literacy among tailors and a significant break with the code of secrecy inherent to the individualized procedures of the past. While I would agree that the ability to think and write in terms of inches altered the form in which proportional theories were conceived, I do not see the lack of this facility as precluding the development of them. It is perhaps more significant that this new literacy (in both words and numbers) provided for the first time a way to communicate proportional theories easily. If a tailor developed a proportional method before the introduction of the inch tape measure, he based it on his direct observations of actual spatial distances rather than on dimensions abstractly coded into inches. His ability to communicate his method by writing was inhibited. He probably would have had to be satisfied with teaching his apprentices—the traditional way for a tailor to share his knowledge. He would, thus, have left no record of his innovations.

It is my opinion that in response to the historical changes already presented, tailors began to exper-

iment with proportional methods before the inch tape measure was widely used, at least by the last decade of the 18th century. The rising literacy of the ensuing era brought these innovations to light and also stimulated the utilization of the inch tape measure.

The 1809 reference to "proportionable scales" suggests that proportional theories were already widely used by the manufacturers of ready-made clothes and by some custom tailors as well. Proportional systems were those cutting methods based on the assumption that all human bodies are formed according to common geometric or proportional rules. It was assumed that with only one critical measurement (usually the circumference of the "breast" or chest) it was possible to predict all other dimensions. The acceptance of this presupposition led to the creation of numerous systems. They varied from each other according to the creator's opinion as to what the critical measurement was, how it should be taken, what measurement tool should be used, what the "true" proportions were, the drafting tool to be used, the location of critical drafting points, and the sequence of drafting procedures. It does not take much imagination to realize how many different systems could be created, based on the proportional assumption.

What these first systems all had in common was the fallacy of their basic assumption. For while, in general, the human form has an established proportional configuration, tailors found that very few individual customers were shaped exactly according to any set formula. Purely proportional systems, nevertheless, continued to be used in spite of this weakness. The need for technological breakthroughs was so great that even a flawed system was better than no system at all.

The tailors who were concerned for quality exercised considerable personal judgement and used many "proof" measures to double check their work. Some were inclined to add more body measurements as an integral part of "improved" systems. Usually these extra measurements were used to draft that portion of the garment directly affected by the particular measurement. Thus "hybrid" systems⁶ developed—methods combining

⁶ The term "hybrid" was not used by 18th or 19th century tailors or dressmakers. I have adopted it to describe systems that are neither purely proportional nor completely direct-measure methods but constitute a blend of the two.

both proportionally determined dimensions and direct measurements. An important step was the recognition that the height of a man did not necessarily have anything to do with his breadth. Thus the direct measurements were frequently vertical dimensions. In 1818 the Englishman Mr. Hearn described his system. Even at this early date he added a direct measurement for the height of the neck (cf. Figure 5) to his proportional system based on the "breast" measure (Giles, 1887:93).

Mr. Hearn's experience reflects the reasoning that many later tailors were to follow. By the fifth edition of his system, in 1832, he had completely rejected proportional theories even when they were modified into hybrid forms. He acknowledged that "most modern cutters amongst us have divided the breast measure into equal proportions for many years." But he was convinced that "the proportions of the breast have nothing to do with the various points of a coat," and that "there can be no certainty in the fit of coats without taking the make of the person" (Giles, 1887:100). His answer to the problem was a direct-measure system. In contrast to previously published instructions, Hearn's precise language and more carefully described procedures, leaving much less to individual judgement, are what make this a "system." For example, the publication of *The Society of Adepts*, 1796, reflected in Queen and Lapsley, 1809, constitutes only the vague directions of experienced tailors accustomed to solving cutting problems intuitively. To identify a drafting method as a system is to say it is a definable, repeatable, systematic procedure.

Hearn was advanced in his thinking. Others were to agree with him, but direct-measure systems never completely replaced either proportional or hybrid methods. During the period that concerns dressmakers' systems, the second quarter of the 19th century, there were proponents of all three kinds of tailors' drafting methods—proportional, hybrid, and direct-measure.

The tools used by tailors also set important precedents for dressmakers to follow. The inch tape measure was the first and most significant improvement upon the strip of notched parchment used by generations of tailors. The square was probably the next to become common. Many systems required no more than these tools. Hearn's 1818 hybrid method and his 1832 direct-measure

technique used only the tape measure.

Some tailors' systems, however, required specialized tools. On 28 February 1827 J. G. Wilson was granted a patent (4,687X) for a "Square for Cutting Garments" (Figure 6). This represented an improvement to a system first described in an 1820 English publication by Edward Minister. As Wilson explained in his manual, copyrighted a month before his patent was granted,

the reports of Minister being only in the possession of a few and unaccompanied with drafts or rules, I was induced to believe that I should perform an acceptable service by improving, republishing, and combining with them a concise treatise on the art of cutting, which I have now the honor of presenting to the trade (1827: Preface).

Wilson's is the earliest restored ⁷ U.S. patent related to tailoring drafting techniques. Of the seven earlier, unrestored patents (see Appendix III), Madison's "Ruler for Cutting Out Garments" and Starr's "Scale for Draughting Garments" could have been issued for devices intended for proportional or hybrid systems.

Tools for accurately measuring the body were patented in significant numbers. These devices usually provided particular measurements needed by a specific direct-measure system. Less frequently, the measurements obtained were to be used with one of the generally known methods. The measuring instruments were basically linear in form. They ranged from simple to fantastic combinations of the square and tape measure (Figure 7). Some had a level or plumb line as an important feature. Still others were designed to support a portion of the body or conform to it.

By the time dressmakers' drafting systems were needed, tailors had given up traditional drafting methods. Many had broken the code of secrecy and were publishing descriptions of their own systems. The relative merits of proportional versus direct-measure techniques were discussed and a variety of tools had been created. Tailors set new precedents for 19th century dressmakers to follow, if it suited them.

⁷ In December 1836 a fire destroyed all the records and patent models dating from the first patent act of 10 April 1790. In 1837 the Patent Office embarked upon a program to "restore" these lost documents, largely from information and drawings supplied by the patentees.

12- APPAREL
[3] Tailoring.

Tailoring Man's Rule



James G. Wilson
Imp^t in the Rule for Cutting Garments

4687+

Patented March 1837

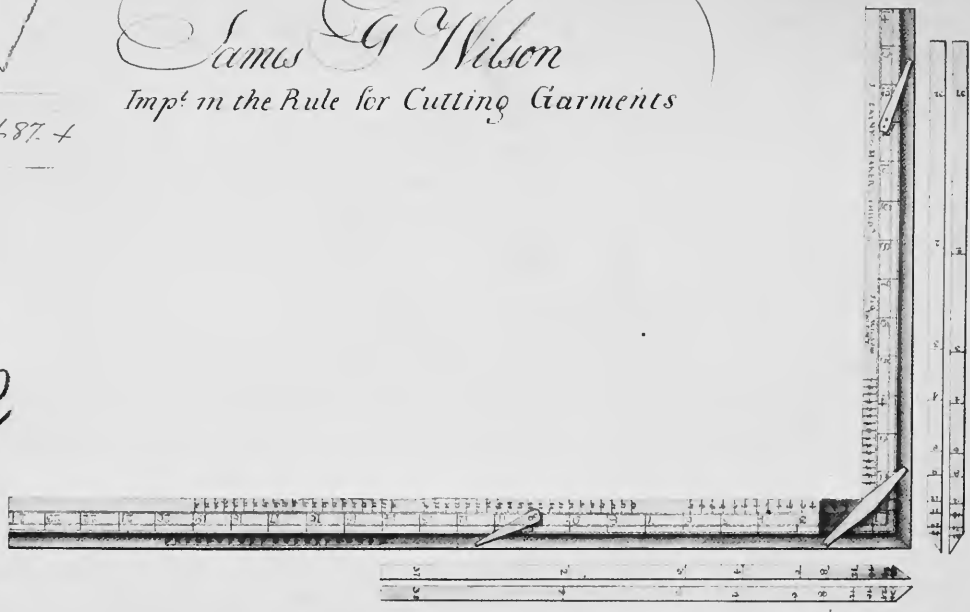

P
0

Patent Office 20th May 1838
Made under the direction of the Commission of
Patents in conformity with the act 3rd March 1837.
Wm. Paton
Commissioner of Patents

73. MEASURING INSTRUMENTS.
[38] Tailors' Measures.

1352 Wm. S. Demme's Apparatus for Taking Measure for a System of cutting Garments

Patented 18 April 1840

No 1556

1556

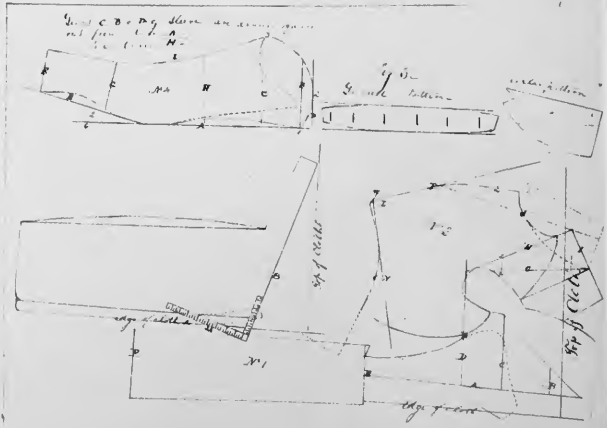
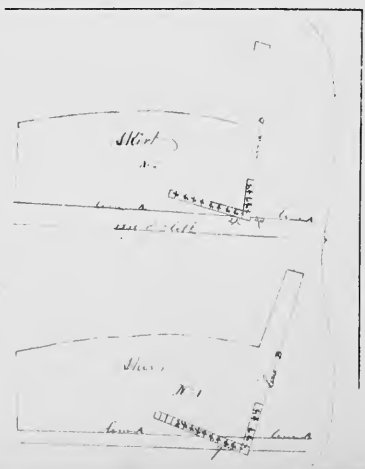
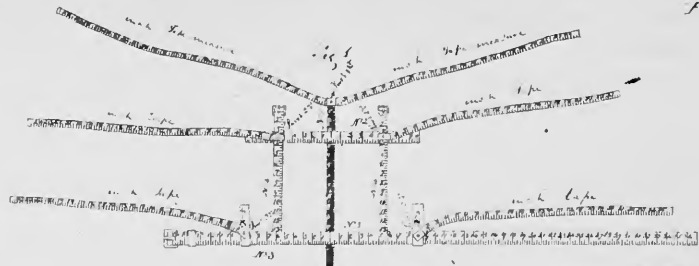

P

192

FIGURE 6 (left top). Restored drawing of a tool devised by James G. Wilson for his hybrid drafting system for tailors. The wood or metal square was made with a recessed channel on the outer edges of both arms. Strips or "gauges" were laid into the spaces and kept in place by "springs." Each strip was marked with the divisions of a specific "breast" measure and could be changed according to the size of the customer. Wilson was granted a U.S. patent (4,687X) for the form of this tool on 28 February 1827. (National Archives.)

FIGURE 7 (left bottom). Drawing for a measuring device created by W. J. Lemmond as part of his direct-measure drafting system for tailors. Strips of "spring steel," leather, and wood—all marked in inches—were combined with six tape measures. This instrument was designed to hook to the customer precisely over the "socket" bone of the neck and to buckle around each shoulder and around the "breast" close up under the arms. Lemmond received a U.S. patent (1,556) for the form and use of this tool on 18 April 1840. (National Archives.)

FIGURE 8 (below left). Details for cutting and assembling a woman's pleated gown or sack (similar to Figure 9), 1769, from Garsault, "L'Art du tailleur," plate 15. *Cut shape of material*: Fig. 1, back; Fig. 2, front. *Detail of pleating*: Fig. 3, back; Fig. 4, front. *Cut shape of material*: Fig. 5, sleeve ruffles; Fig. 6, sleeve and "compere" or buttoned front. (Smithsonian Institution.)

FIGURE 9 (below right). Back and front views of a woman's pleated gown or sack, 1769, from Garsault, "L'Art du tailleur," plate 3. (Smithsonian Institution.)

Mantua-Makers

In 1747 the *Description of All Trades* remarked that for the mantua-makers' trade "there is little else wanting than a clever Knack at cutting out and fitting, handsome Carriage, and a good set of Acquaintances" (Waller, 1747:134). No contemporary English or American description exists to reveal the procedure followed by the mantua-maker. A 1769 French source,⁸ however, describes the techniques followed by a *maîtresse couturière* when she constructed a sack. The mantua-maker probably followed a similar method, although it seems likely that the final dimensions and location of the back pleats⁹ in the mantua were determined during a fitting when the dress was on the customer.

Like the tailor, the 18th century *maîtresse couturière* recorded her customers' measurements by cutting notches on a strip of parchment or paper. As many as 16 measurements were taken for one gown. She followed, however, a cutting procedure different from that used by tailors. She did not use patterns. Instead she used the measure to determine the correct length of the pieces of fabric needed to make the gown (Figure 8). The *maîtresse couturière* continued to use the measure as a guide as she progressively sewed and cut her way to a finished garment (Figure 9). Inches were

⁸ Garsault (1769, vol. 31) and other derivative sources annotated in footnote 5.

⁹ See footnote 4.

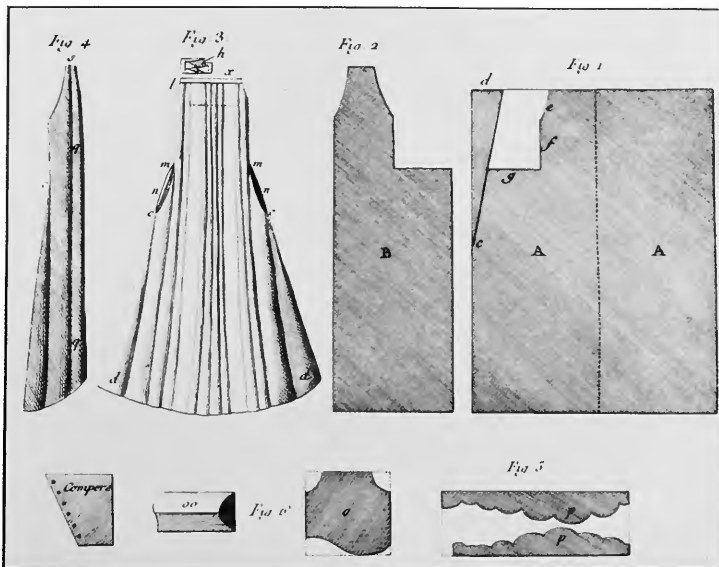



FIGURE 10. Fashionable evening dress from the July 1814 issue of *Repository of Arts*.
(Smithsonian Institution.)

used on the rare occasions when a specific direction was given concerning a dimension. For example, the 1769 French source stated that the four pieces of the back and the two for the front “should be cut a little longer” than the measure “by several inches” (Garsault, 1769:49).

For most of the 18th century, women’s fashions developed in accord with men’s fashions—evolving toward a closer and closer fit. By the early 1780s

the mantua was so fitted that the stitched pleats, which had become reduced in depth and moved far to the center back, were finally replaced by seams. The subtle shaping of the top of the gown was achieved through complex cutting as demanding as any required of a tailor. If this style had remained fashionable for any length of time mantua-makers would have been forced to develop their own drafting systems. Instead, the simultane-

ous emergence of another, less fitted fashion was to postpone the mantua-makers' need for systematic cutting techniques.

This new style first came to popular attention when Vigee Le Brun's portrait of Marie Antoinette, wearing a gown of gathered sheer cotton, was exhibited at the Paris Salon in 1783 (Waugh, 1969:73). The dress—later called “chemise de la reine”—created a sensation. It was an extraordinary shock to see the queen of France dressed not in the precious jewels, laces, and silks befitting her station but in a gown so simple that it reminded the viewer of the common feminine undergarment called a “chemise.”¹⁰ Because of its informality and unassuming character this garb suited the romantic longing for the uncomplicated rustic life that was popularly effected by the French nobility just before the revolution. The neoclassical movement that swept over Europe a few years later reshaped this garment into the style now generally known as “Empire” (Figure 10).

These high waisted dresses of the late 18th and early 19th centuries were mostly unfitted skirt and thus they required more of a draping technique than drafting. The patterns for the bodices of this garment were cut directly on the customer (Figure 11). This accurate but time-consuming technique was probably first adopted by mantua-makers in the 18th century when gowns became precisely fitted and subtly curved creations. Those who could afford fine gowns had the leisure to spend long hours in the fitting room. This “pin-to-the-form” technique was then easily adapted for cutting the simple short-waisted “Empire” styles of the 19th century and it continued to be used long after

¹⁰ A slip is the closest modern equivalent to the 18th century chemise.



FIGURE 11. Cutting a dress according to the pin-to-the-form technique, from Tabart & Co., *The Book of Trades*, London, 1804. (Library of Congress.)

fashions changed once again, requiring more complex cutting. The amateur dressmaker usually followed another time-honored custom, that of taking a pattern from an existing dress or lining.

A 19th Century Invention

As long as fashions evolved slowly or called for simply cut dresses, and as long as the market for fashionable clothes was limited to a relatively small leisure class of women, traditional cutting methods were satisfactory. But coupled with the rise of the middle class and the urban society was the fact that fashions continued to change and at an increasing rate as the 19th century progressed. These new

fashions called for more fitted garments of more complicated cut. To keep informed of the latest innovations customers and dressmakers eagerly sought European magazines with fashion illustrations. When American magazines such as *Godey's Lady's Book* and *Peterson's Magazine* were established in the second quarter of the 19th century, they included fashion plates that were copied from



FIGURE 12. July 1834 fashion plate dramatically showing the broad-shouldered, normal-waisted styles popular in Europe and the United States, from the English periodical *The Lady's Magazine*. (Smithsonian Institution.)



FIGURE 13. May 1839 fashion plate illustrating the sloping-shouldered, small-waisted styles shown in the Philadelphia magazine *The Lady's Book*, published by Louis A. Godey. (Smithsonian Institution.)

European illustrations. These widely distributed publications gave women, even in remote areas of the United States, the opportunity to learn about fashionable styles.

The fashion plates, however, did not show the viewer how to cut a pattern that would produce a similar garment. This difficulty was partially alleviated when, in 1853, *Godey's Lady's Book* started to supplement the fashion illustrations with simple diagrams.¹¹ When *Peterson's Magazine* also began to include pattern diagrams in 1855, inch measurements were added to clarify the dimensions of the pieces. *Peterson's* stated that a tape measure was indispensable when using these miniature patterns. "Where it is difficult to buy such a measure, one can be made, in half an hour, out of a piece of tape, with the assistance of a foot rule borrowed from a carpenter, or the aid of a yards-stick" (1855:247). When *Godey's* began to include inch measurements on its pattern diagrams the reader was told that the pattern would fit "a lady of middle height and youthful proportion" (Figure 14) (Jul 1855:65).

Full-size "patterns," of one size only, were also produced. As early as 1854, *Godey's* was selling these models constructed of paper, which they described as "facsimilies of the originals in color, trimming etc. At a distance, they would be taken for the garment itself. They could be worn in a *tableau* without being detected" (Feb 1854:467). *Godey's* continually pointed out that these were not simply unmarked flat pieces made out of tissue or old paper! This was an important distinction as the Godey patterns were very expensive, ranging in cost from \$0.31 for a sleeve pattern to \$1.37½ for a full dress pattern (Feb 1855:183). In comparison, a dressmaker who stayed with a family until she had completed her work earned only \$0.75 a day (*Godey's*, Sep 1851:192). Much simpler full-size tissue patterns could be ordered from a number of shops and were even included in certain publications such as *Mme. Demorest's Quarterly Mirror of Fashion* (Figure 15a). In this magazine the patterns were cut pieces of tissue paper, generally for dress accessories or sleeve details. It should be remembered that these full-size patterns were not offered in a range of sizes. Fitting still had to be done by

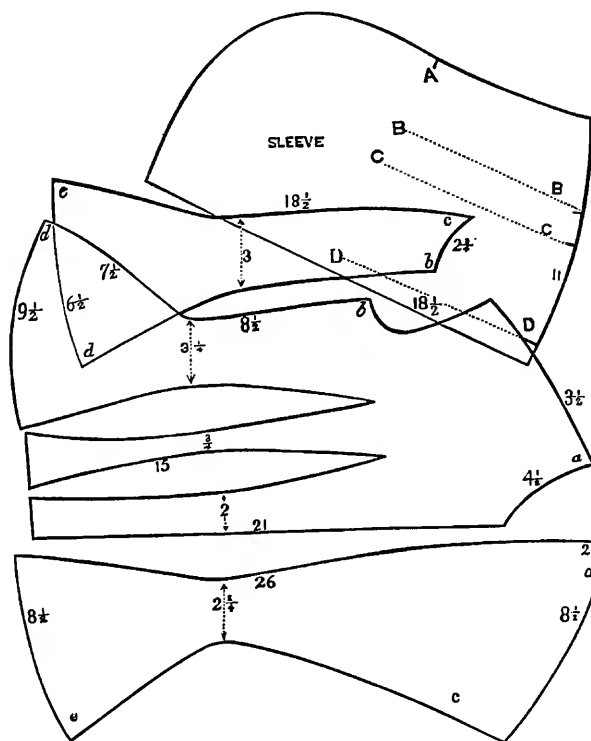

FIGURE 14. A woman's garment elegantly called "Coraco Eugenie," from July 1855 issue of *Godey's Lady's Book*. Above: small diagram of pattern. Right: fashion illustration. (Smithsonian Institution.)

the "pin-to-the-form" method.

Despite the availability of such patterns, cutting a dress that fit well became more difficult as fashions called for more closely fitted garments. To be successful, a dressmaker had to solve a number of problems. Like the modern naval architect who designs the covering for a complexly curved form—a ship's hull—the dressmaker had to cut the sheathing for a complexly curved figure—a fashionable female shape. (As will be described later, the drafting curves used by these two trades are also similar.) But by comparison, a modern naval architect has a less demanding task when he is planning the layout of the plating required to cover the outside of a ship's hull. A ship's hull, particularly below the waterline, may have both convex and concave curvature. When the naval architect designs the shapes of the metal plates needed to cover a hull, his prime concern is the most efficient use of the standard sized sheets of metal. Efficiency, however, was not the chief de-

¹¹ Fashion plates, diagrams, and unsized patterns were available in England (Arnold, 1964, and Waugh, 1969) before they were produced in the United States.



terminant of the way the 19th century dress cutter used her materials to cover the curved form of her customer. To be successful, the dressmaker had to follow the dictates of fashion that were beyond her control. If she had a thorough understanding of anatomy, her tasks might be made easier, but most fashions of the 19th century prescribed dress shapes that had little relationship to the natural form of a woman's body.

The naval architect deals with a rigid, static form. In contrast, the 19th century dressmaker dealt with the ever moving human body which could assume a variety of postures. Her customer might stoop naturally or lean slightly to one side or the other. Yet, many individuals have a tendency to stand more erect than usual when being measured, thus making the dressmaker's calculations incorrect.

Once the naval architect designs the most efficient manner of covering a hull there is no need for modification each time an additional ship of the same class is built as the hull shapes are the same. The dressmaker, however, did not have this advantage. Each customer had different proportions and different shapes occasioned by variations of the anatomical structures common to all human females. She could not even assume that she was dealing with a symmetrical form, as the left half of many individuals measures differently from the right. And the ultimate frustration for a dressmaker was that her customer could change size between dresses by losing or, more likely, gaining weight. Even worse, the customer might change her shape between fittings, having violated the unspoken rule by wearing a different corset for the final fitting than she wore for the first.

When fashion dictated closely fitted garments of a specific form, individual variations became critical. The fashion plates, diagrams, and single-size patterns only helped the dressmaker keep informed as to the latest fashionable silhouettes and pattern shapes. They did not help her cut a garment that fit. Only a dressmaker with extensive experience could quickly make a fashionable fitting garment by the old "pin-to-the-form" technique. A more efficient method was needed.

In the 18th century the sparse population in America created a labor shortage and a more open society than existed in England. A widow could respectably continue the work of her husband whether it was managing the family plantation, newspaper, or tavern. By the 1840s however, in-



FIGURE 15a,b. Full-size cut patterns included in the Summer 1864 issue of *Mme. Demorest's Quarterly Mirror of Fashion*. (Smithsonian Institution.)

FIGURE 15a (above). Three-piece tissue pattern for a girl's apron.

FIGURE 15b (right). Pictorial and descriptive presentation of several sets of patterns (girl's apron shown in upper left).

creases in population and affluence contributed to the reassertion of strictly defined, limited roles for women (Lerner, 1973:90). There were impressive exceptions, but, on the whole, for a 19th century woman to be a wage-earner was for her to lose caste. If a spinster or a widow in the 1840s did not have family with which to live nor an exceptional talent, she had little choice as to how she would support herself. Other than becoming a street walker, her opportunities were restricted to traditional feminine activities of child care, housekeeping, cooking, and sewing. If a woman had some education but no children, she might become a governess. Later in the century, teaching in public schools was to become an important alternative for the educated woman, but neither educating women nor recognizing women as educators was

AND OF THE

ILLUSTRATIONS **DESCRIPTIONS**

FULL SIZE PATTERNS.

CUT READY FOR USE

CUFFS. TWO STYLES

TRAVELING CLOAK

The short round cloak on the principal figure above is the trimmed representation of one of the cut patterns in this number, and is the size preferred when made *en suite*. The trimming is fine molar, laid on as illustrated, and stitched flat.

BOY'S JACKET.

This is a charming little jacket, not difficult to make and easily finished. The flat pattern is printed on the sheet with the grid in perforated lines on it. The jacket and the skirt have each the same size pattern on them.

GIRL'S APRON.

Is one of the cut patterns, consists of skirt bodice and pocket lid. Suitable for a girl of six or seven years.

SLEEVE.

This pattern consists of the body of sleeve, which is cut in half, both sides being exactly alike, and a narrow band which combs the opening at the back, also a wider piece, not straight; two of these alike are put on, braided, and finished to correspond with the rest of the sleeve; they cross at the top.

LINEN CUFF.

Deep cut, pointed in the back, where it buttons. It is made of linen cambric, double, the buttonholes are scalloped and stitched, printed full size on pattern sheet.

BODICE.

This pattern is also printed full size on the pattern sheet, and consists of three pieces: back, which is the largest, a second part—third and smallest, which is the centre of the front.

popular in the 1840s (Melder, 1972:19-32). For the many women with little formal education, the main choices were limited to being a cook, laundress, household servant, or seamstress.¹²

The flood of European immigrants in the last half of the 19th century added great numbers of men and women to the labor population. Imbued with democratic principles of equality, Americans, whether they were first, second, or third generation, had a growing distaste (if not hostility) for accepting the subservient status of domestic work.

Being a seamstress was not a promising alternative to employment as a household servant. In 1854 *Godey's* related that a widow supporting two children by sewing garments cut by a tailor was paid seven cents for common shirts, twelve cents for common trousers, twenty cents for finer ones, and thirty cents for cloth jackets. The most she could earn doing hand sewing for a full day and half a night was twenty-five cents. Yet she paid three dollars a month rent for one room (May 1854:467). The working conditions of this seamstress were harmful to her health, and her labor did not provide the income to sustain her and her two children. This occupation was to be avoided if possible.

A woman with sewing skills saw dressmaking, however, as an avenue by which to escape the degrading alternatives. This trade offered the hope of being successful enough to have one's own shop. There was the potential for a respectable place within the commercial world. But success required considerable skill, particularly in cutting, not normally a part of a

housewife's training and experience. A long apprenticeship, the usual method for acquiring such skill, was not possible for the widow with children to support. And, with the limited aids available, it was unlikely that an untrained woman could learn the trade quickly enough to support herself. Drafting systems that worked and that also could be learned easily became an important key in the efforts of women to unlock the doors to dignified economic independence.

The final incentive for the commercial development of workable drafting systems was added by the advent of the sewing machine, which became available in the early 1850s. By dramatically reducing the sewing time spent on a dress it emphasized the amount of time and skill required to cut a dress successfully. Only three years after Isaac M. Singer was granted his first patent, *Godey's* wistfully exclaimed, "If some ingenious 'Singer' would invent a machine that would cut and fit our own . . . dresses . . . the agony of weeks would be over in a few days" (Jun 1854:570). By 1868 the general adoption of the sewing machine by "private families" created "an absolute and pressing demand for . . . a system for cutting garments as will enable every family to cut all kinds and sizes, in the most perfect and fashionable style" (Powell & Kohler, 1868:1).

The pressures created by changing fashions, more fitted styles, rising middle-class markets, and the financial needs of untrained women provoked the creation of dressmakers' drafting systems in the 19th century. The availability of a workable sewing machine when added to the interacting combination of these social pressures, provided an impetus that significantly increased the momentum of this creative activity as the century progressed. Technology filled a dramatic role as a necessary component of social change.

Earliest Evidence of Dressmakers' Drafting Systems

Although my speculations place the creation of the earliest dressmakers' drafting systems between 1820 and 1838, it may never be possible to identify exactly when the first was devised. Nor is it certain who created the earliest of these methods.

Possibly tailors devised the first systematic techniques used for making dresses. After all, some

tailors cut women's riding habits as a regular part of their trade. The heavy materials and traditional masculine styling of these habits required the strength and the specialized cutting, sewing, and pressing skills that were essential to the tailoring craft. Nevertheless, as the 1809 Philadelphia publication pointed out, habit-making was quite differ-

¹² Working in a textile mill was respectable employment for some women. This opportunity, however, was only available in New England and only for about two decades. By the late 1830s the influx of immigrants supplied a strongly competitive work force willing to work for subsistence wages (Lerner, 1973:97).

ent from the rest of the trade, “as different as that of a cabinetmaker and a carpenter” (Queen and Lapsley, 1809:53). Thus this feminine apparel was only occasionally considered in tailors’ manuals.

Nineteenth century tailors delicately avoided saying that the greatest problem with ladies’ habits was that women were shaped differently from men. Already the average tailor was having difficulty covering the varieties of masculine figures that stood before him in different postures. When faced with the unpredictable size of women’s breasts, many tailors gave up. James G. Wilson, however, was one tailor-inventor who attempted a solution to this prominent problem. In 1827 his hybrid system used divisions of half the “breast” measurement to draft men’s coats (Figure 6). For ladies’ habits and pelisses, however, he advised his readers to use half the waist measurement (1827:14). Wilson’s innovation could be viewed as support for the speculation that a tailor devised the first dressmakers’ drafting system. But I have found evidence that has convinced me that another type of person created the method that spawned generations of these systems.

The earliest system that I have found that was specifically designed for cutting dresses was a proportional method using a perforated tool. This drafting device was illustrated (Figure 16a) and discussed as background in the application for the first U.S. patent granted for a dress cutting system. This patent was issued to Aaron A. Tentler of Philadelphia, on 23 January 1841. Tentler based his system on this earlier work by persons unspecified, which he described in order to demonstrate “all that has been attempted in this way prior to the invention of my improvements” (U.S. Patent 1,944).

The latest date for the creation of the pre-Tentler system can be established by considering when Tentler began developing his method. Although Tentler applied for his patent on 18 June 1840, the internal evidence of the patent application shows that he must have started his work significantly prior to this date. His system was designed to cut a bodice with a round, slightly raised waistline, full leg-o-mutton sleeves, and a wide cape collar (Figure 16b,c). Dresses that emphasized a broad shoulderline in this manner started becoming popular in the late 1820s. The expansive sleeves and cape collar evolved to their greatest breadth in the early 1830s (Figure 12) and

remained popular to 1836. After this date the sleeves quickly collapsed and the collar shrunk. Publications originating from Tentler’s home city in 1839 showed dresses cut without the cape collar and with sleeves that fitted closely to the upper arm (Figure 13). Tentler probably started working out his method when dress fashions dictated that a woman should have shoulders so broad that they would have impressed a 20th century football player. At the latest, he must have started his modifications by about 1838 when some Philadelphia women were still wearing the older styles. This line of reasoning projects a date prior to 1838 for the earlier system.

The next question to be answered is, who created this pre-Tentler system? Since all the previously discussed tailoring and dressmaking techniques and aids were used earlier in England, it would be reasonable to expect that the pre-Tentler system also had a European origin. But I have found nothing to support this expectation. To the contrary, there are no English or French patents for any dressmaking drafting system dating as early as the Tentler patent. And, the two individuals who have done research on this subject in England conclude that 19th century dressmakers either did not use “scientific systems” at all (Waugh, 1969:185) or else that they began using them very late, in the 1870s (Arnold, 1973:124). Thus it seems likely that the pre-Tentler system originated in the United States. But can the creator be identified?

I have found several isolated references suggesting an individual named Fowler as an early creator of a drafting system for dresses which stimulated the development of many others. The earliest reference appears in an 1857 instruction book for a dressmaking system published in Cincinnati by a physician, Dr. E. P. Minier. In the middle of a vitriolic criticism of his rivals, Dr. Minier qualified his statements by remarking, “I do not desire to detract from the credit due Mr. Fowler and others in the benefits they have conferred upon the ladies through their models and card plans of cutting. They are vastly better than no plans . . . but they have now had their day” (Minier, 1857:7).

A year later in New York City, Samuel T. Taylor described in his monthly periodical *Le Bon Ton* how he exposed the flim-flam practices of an alleged creator of a system. “I told her it was nothing but a duplicate of Fowler’s model . . .” (1858:182).

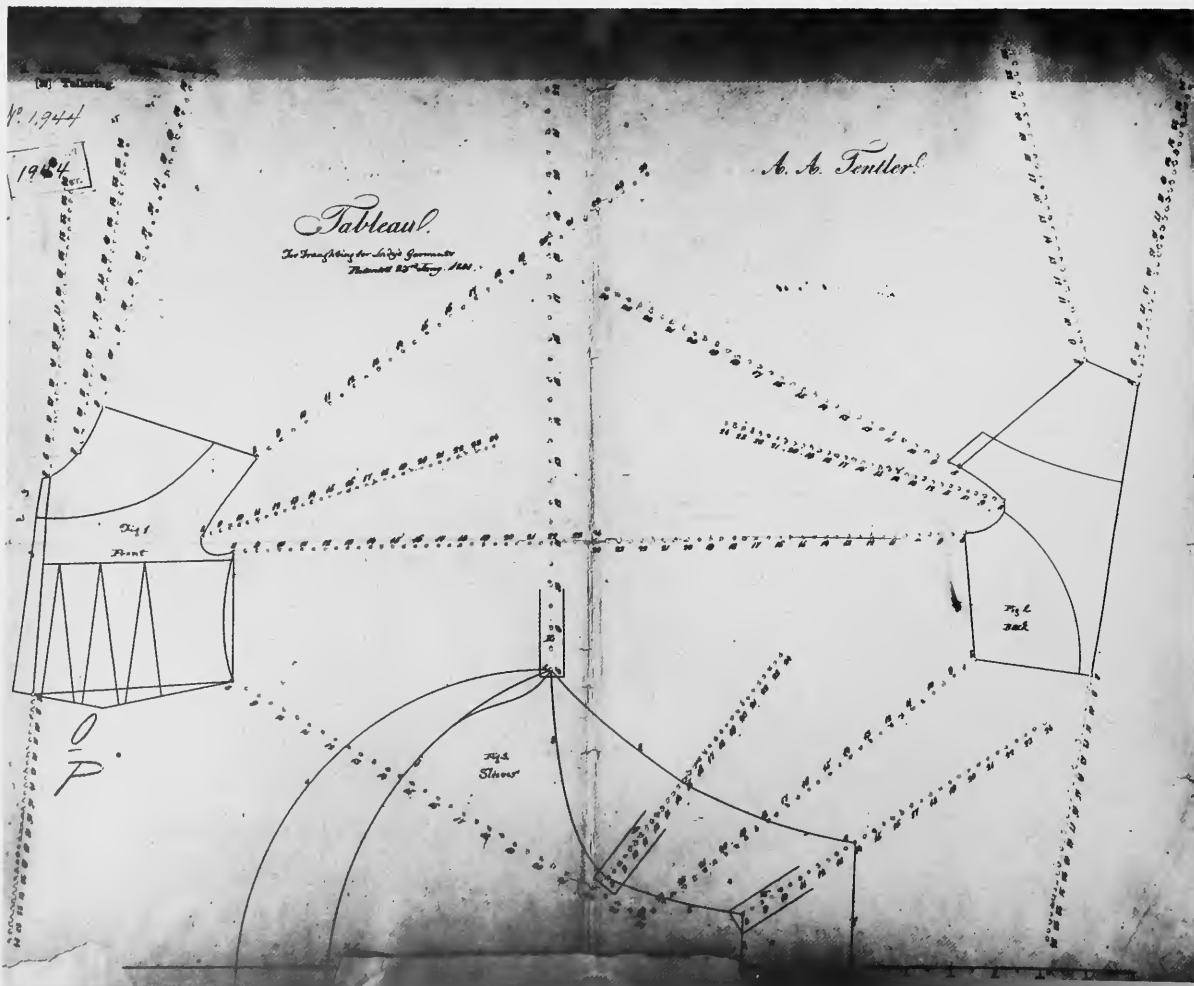
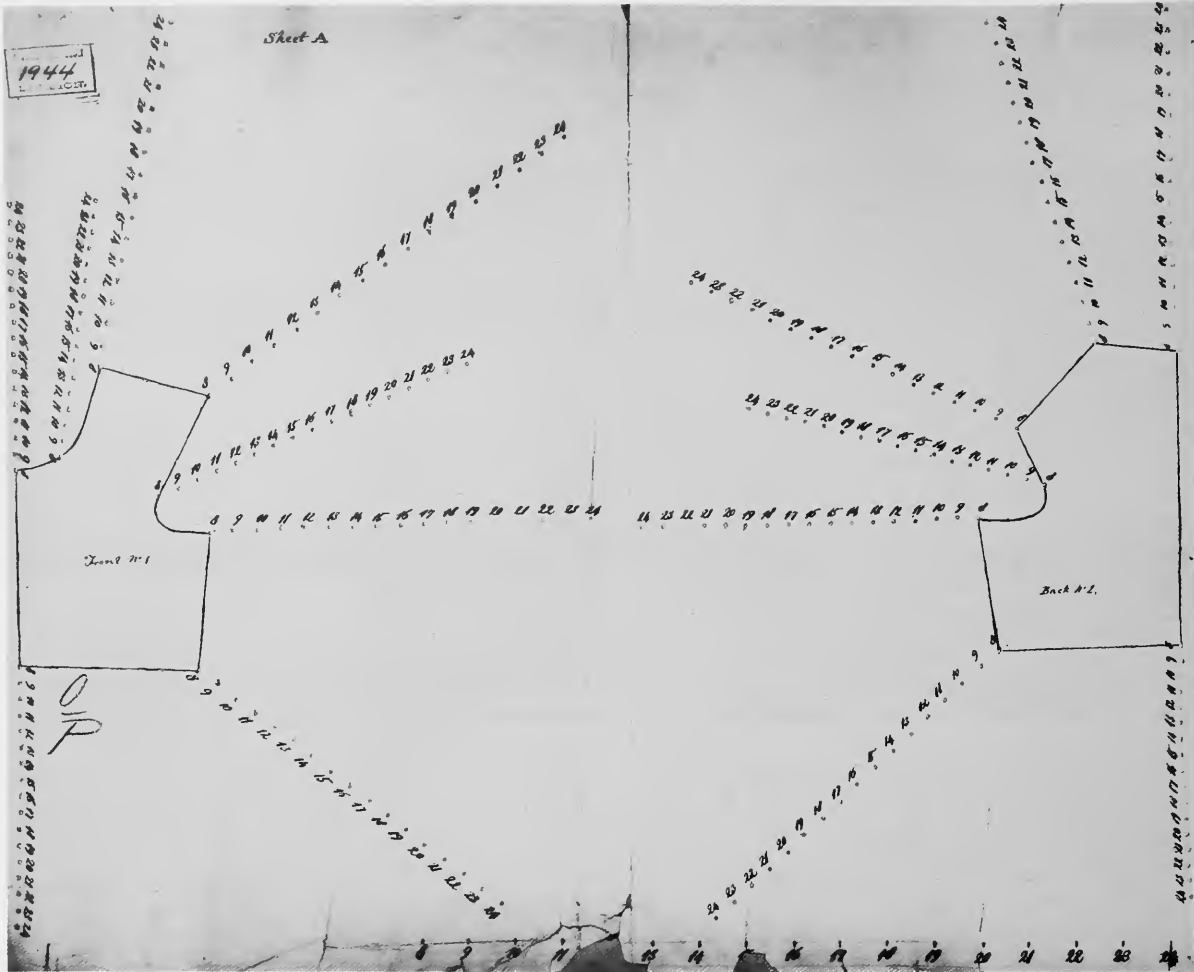

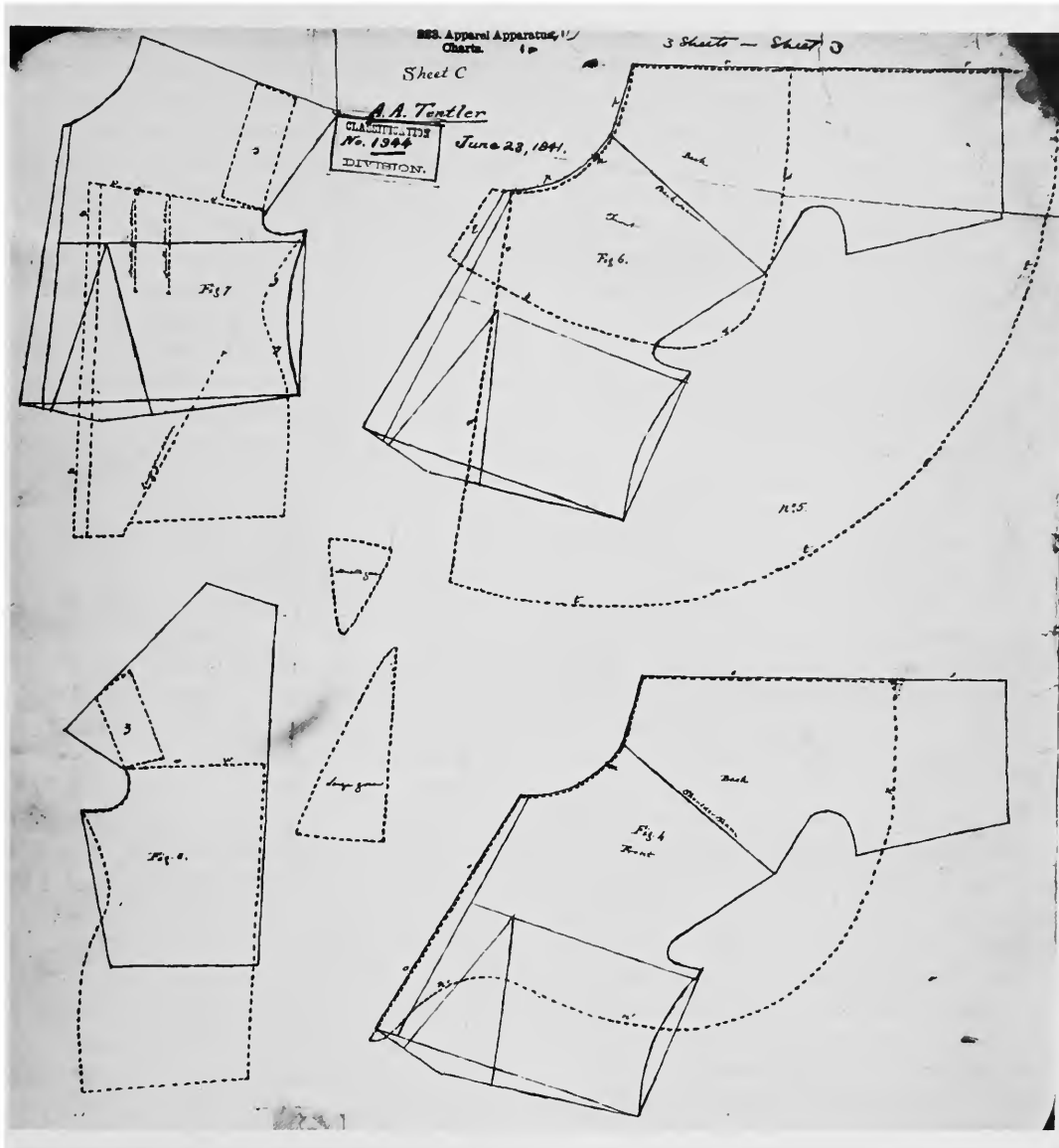

FIGURE 16a-c. Set of three drawings submitted by Aaron A. Tentler as part of his patent application for a perforated paper tool for a dressmakers' proportional drafting system (U.S. Patent 1,944, 23 January 1841). (National Archives.)

FIGURE 16a (left top). First sheet, 52.3 x 67.9 cm, Tentler's drawing of a tool (for drafting a bodice front and back) predating his own and which he judged to be "all that has been attempted in this way prior to the invention on my improvements."

FIGURE 16b (left bottom). Second sheet, 58.4 x 68.0 cm, Tentler's tool for drafting: Figs. 1, 2, bodice front and back with variations; Fig. 3, sleeves of two categories of sizes.

FIGURE 16c (above). Third sheet, 51.4 x 47.8 cm, showing the use of the basic front and back bodice pieces (second sheet) in drafting: Fig. 4, cape-collar (cf. Figure 12 this study); Fig. 5, cape (probably for outer wear); Fig. 6, collar or yoke; Figs. 7, 8, front and back of corset (this last technique not covered by the patent). Date on this sheet, "June 23, 1841," appears to be a copying error (cf. second sheet).

In 1861, Taylor was bemoaning the money wasted on worthless charts and models when he referred to Fowler as “the beginner . . . of this great humbug” (1861:247). These references show that Fowler’s fame (or infamy, in the opinion of those who were selling another type of system) extended at least from Cincinnati to New York City. Fowler was still known years later in New York. An 1885 instruction booklet extolling the virtues of Cornwell’s system stated that “the invention of the first chart, (Fowler’s Theorem, erroneously called Fowler & Wells’) occurred some 40 years ago” (Cornwell, 1885:8).

Although Fowler’s contributions were widely acknowledged, I have yet to discover anything more specific about the identity of this person. Working on the possibility that Fowler was a tailor, I examined city directories and census reports for the period 1820 to 1845 for Cincinnati, New York City, and Philadelphia. I discovered too many Fowlers rather than too few. Fowler was not an uncommon name. In Cincinnati, James Fowler was listed as a tailor in an 1836-1837 directory and William Fowler in 1842. In New York City one John Fowler was cited as a tailor until 1822 while another practiced this trade throughout the 1820 to 1845 period. Abraham Fowler was listed from 1827, Simeon L. Fowler from 1832, and Henry Fowler from 1835 to 1840. And in Philadelphia Mahlon Fowler was listed as a tailor from 1840 to 1845 and Rennels Fowler appeared in 1844 and 1845. Without a first name or initial to narrow down the possibilities exposed by this search, we are not any closer to identifying the creator of a drafting system. An additional problem is that the unidentified “Fowler” may not have been a tailor. This possibility becomes more plausible once the pre-Tentler tool is examined and its use is understood.

The pre-Tentler system required a perforated tool, a heavy sheet of paper with a series of holes through which the drafting points were marked (Figure 16a). Eight series of perforations were used for the bodice front and seven were provided for the back. The specific perforation in each series needed to draft a bodice for an individual was identified according to half the “girth of the body.” This measurement was “taken around the body of the person to be fitted, immediately under the arms and over the breast” (U.S. Patent 1,944:1). The pre-Tentler system was a proportional method based on a measurement similar to the

dimension required in the many earlier tailors’ proportional methods. The drafting tool, however, was not like any device used by tailors. I have found no precedents in the tailor’s trade for a perforated tool nor any evidence of a device made from a flat, rectangular sheet of paper.

The simplicity of the pre-Tentler procedure also makes this system exceptional. Apparently, it was assumed that the dressmaker would not have a tape measure, as a strip of paper was used for measuring. The dressmaker folded the strip in half and held it up to the inch scale printed at the bottom of the sheet. If the breast measurement was 36, she marked the fabric through the perforations numbered 18. Then she removed the tool and drew the appropriate lines between the drafting marks. The dressmaker followed five mechanical steps, none of which required any “figuring.”

I have discovered no prior garment drafting system that used a tool like this. No other method was so simple. It was easy enough for an untrained person to use. The uniqueness of this pre-1838, pre-Tentler system prompts me to speculate that this method was not created by a tailor for use in the tailor’s trade. It seems most likely to have been devised by someone who was enough removed from the inbred intricacies of the tailor’s craft to put together a method that would appeal to potential women users.

It was suggested to me that this individual could have been Orson Squire Fowler (1809-1887) who is now most admired as a proponent for octagon shaped dwellings. In the 19th century, however, this Fowler was widely known as an energetic proponent and practitioner of phrenology, the field of study which alleged that the character and future development of an individual could be determined by studying the shape and conformation of the skull. Orson Fowler was a prolific writer of magazine articles and books published mostly by his own firm. The majority of his work was concerned with phrenology, physiology, and subjects related to human health.

With his preoccupation with the human body, which led him into specific studies of “female” topics, Fowler is most possibly the creator of “Fowler’s Theorem.” He was, however, surrounded by relatives who were also active in the same fields: brother Lorenzo Niles Fowler (1811-1896), sister-in-law Lydia Folger Fowler (1823-

1879), sister Charlotte Fowler Wells (1814-?), and brother-in-law Samuel Roberts Wells (1820-1875). All were active lecturers and writers, individually and with Orson Fowler. Most of them were involved at one time or another with Orson's publishing firm. I have not located, however, any writings of this prolific group that could have become known as "Fowler's Theorem." The following clues, however, suggest that an intensive perusal of these many publications would turn up the hard evidence that is needed. In the previously cited 1885 instruction book it was stated that "Fowler's Theorem" was sometimes, although "erroneously," called "Fowler and Wells'." In 1844 the name of the publishing firm of O.S. & L.N. Fowler was

changed to Fowler and Wells.

Thus, the earliest system that I have found for drafting dresses is the pre-Tentler system dating before 1838. It was probably created in the United States, possibly by a person named Fowler, who might have been Orson Squire Fowler or one of his related colleagues.

Setting these speculations aside, it is important to recall the two unique characteristics of this pre-Tentler system: fixed drafting points delineating one style of dress and the use of perforations in marking these points. These features spawned a new breed of drafting systems. Of special significance is the fact that these were systems specifically for cutting dresses.

Proportional Systems

In 1842 Aaron A. Tentler observed that "the learning of the trade [dressmaking] requires a long time, and is . . . expensive and difficult." With his system, however, "every lady may learn to make any kind of dress herself, in a short time" (1842:3). Tentler's system was a modification of the earliest dressmakers' drafting system so far discovered. He projected it for the woman who was not an experienced dress cutter. Unfortunately, little has been learned about him. Tentler's address on his patent application was the "S.E. corner of Coats and Budd Street, Philadelphia." He was listed in the 1840 census as living at 13th and Budd Street and he was described as being between the ages of 20 and 30 and engaged in a manufacturing trade. Also in his household were a woman of similar age, another female between 15 and 20, and a child under five. Tentler was not, however, included in any of the Philadelphia city directories. Thus no clue has been found as to his occupation or what led him to create a drafting system intended to help the untrained dressmaker.

Whatever his background, Tentler was not guilty of plagiarism. In his patent specification he stated that he did not invent the "principle or plan" of the scale by which he made his drafts. Instead he "improved and extended" an earlier technique (Figure 16a) "so as not only to render it correct in its results, but also to make it applicable to a number of purposes . . . to which it could not be applied in its original form" (U.S. Patent 1,944:1).

Tentler was granted a patent on 23 January 1841, for two claims. The first was for "the applying of the measure of the half girth of the body . . . to the drafting of the sleeve, by the aid of the lines of punctures, or perforations" (U.S. Patent 1,944:3). His method for drafting the sleeve was actually a hybrid system (Figure 16b). Three drafting points for the sleeve were determined by the half girth measure, but the direct measurements of the arm length and the wrist circumference were also used. Tentler also suggested a form of sleeve appropriate for the normally proportioned arm and another for the short and fat arm.

Tentler's second claim concerned a more sophisticated application of the tool. He claimed recognition for his method of drafting capes, yokes, and collars by using the bodice fronts and backs after they had been defined by the proportional method (Figure 16c). These deep collars and capes, cut to fit over the exaggerated breadth of the leg-o-mutton sleeves, were an important element in the attire of a fashionable Philadelphia lady before 1838. Tentler also discussed and illustrated how to cut corsets using the draft of the dress as a guide (Figure 16c). But this technique was not included as one of the claims for which he was granted a patent.

According to his patent specifications, Tentler's procedure for drafting the front and back of a dress was the same as the earlier method (Figure 16a,b) already described; Tentler only altered the

placement of the lines of perforations. His instruction booklet, however, directed the dressmaker to adjust the proportional draft according to two proof measurements. Half the front breast measurement was used. Also, the direct measurement of the underarm length "from where the sleeve is sewed in . . . down as far as the waist may require" (1842:5) was used to adjust this dimension on the pattern. Tentler realized that the height of a woman had little to do with her breadth. Or as he put it, "one person is tall and thin, and another stout and small" (1842:8). Half the actual waist circumference was used to determine how much of the waist of the pattern would be assigned to the "breast plaits" or bust darts. All of the measurements were taken with a strip of paper one and a

quarter yards long and one and a half inches wide. They were recorded on the strip by notches and identified by numbers.

The salient features of proportional drafting systems with perforated tools were used long after Tentler's modifications. Only fragments remain of a perforated proportional system published in 1859 (Figure 17). Justin Clavé, describing himself as a "Professor of Mathematics," claimed to be the creator of this "New Geometrical Method." Both the chart and the instructions were lithographed on a single sheet of paper by P. S. Duval and Son of Philadelphia. The perforations for marking the drafting points were not punched during the manufacture of the chart. Instead the holes would have been made during its use. Unfortunately, the

FIGURE 17. The instructions and tool (intended to be perforated) for Justin Clavé's 1859 proportional system printed in Philadelphia on a sheet of paper, originally 61 x 91 cm, which was sold for \$2. (Library of Congress.)

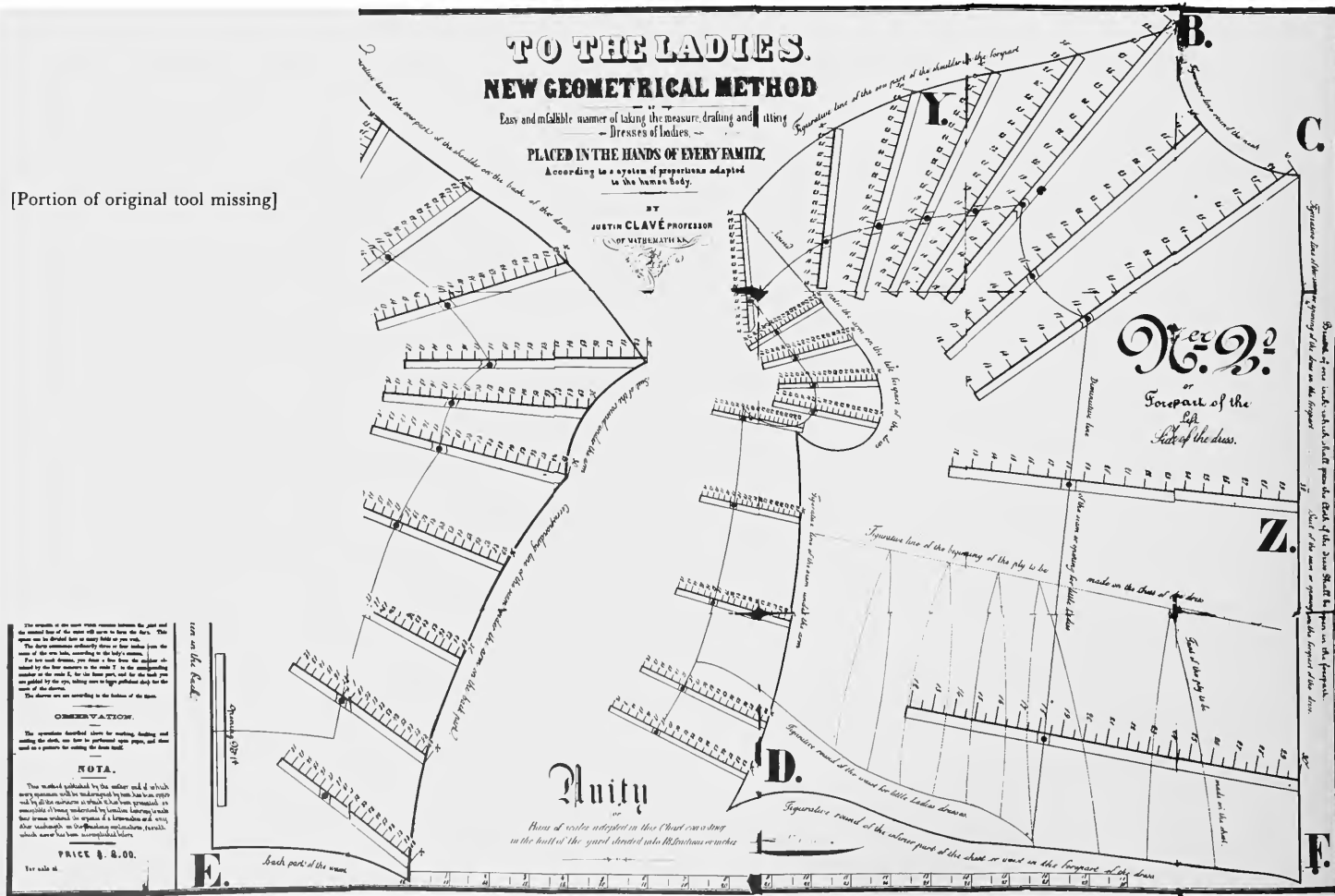

[Portion of original tool missing]

major portion of the instructions were printed on the section that has been lost. After comparing the measurements, however, I believe that this system was a proportional method with the drafting points designated by the circumference of the waist. Clavé's chart drafted dresses with waists measuring from 12 to 30 inches. Considering the stylishly tight corseting of the day, this drafting device did accommodate most of the ladies who would be

likely to own a fashionable dress. The inch scale at the bottom of the tool suggests that the waist measurement was taken with an unmarked strip of paper or a string.

"The American Delineator" was the confident name given to a system that had a tool of cruder appearance than Clavé's chart (Figure 18). According to the printing on the tissue paper, Mrs. H. McMillen, of Clyde, Ohio, secured a copyright for

FIGURE 18. Tool printed on tissue paper (intended to be perforated) that was required for the 1864 proportional system offered by Mrs. H. McMillen of Clyde, Ohio. (Warshaw Collection, Smithsonian Institution.)

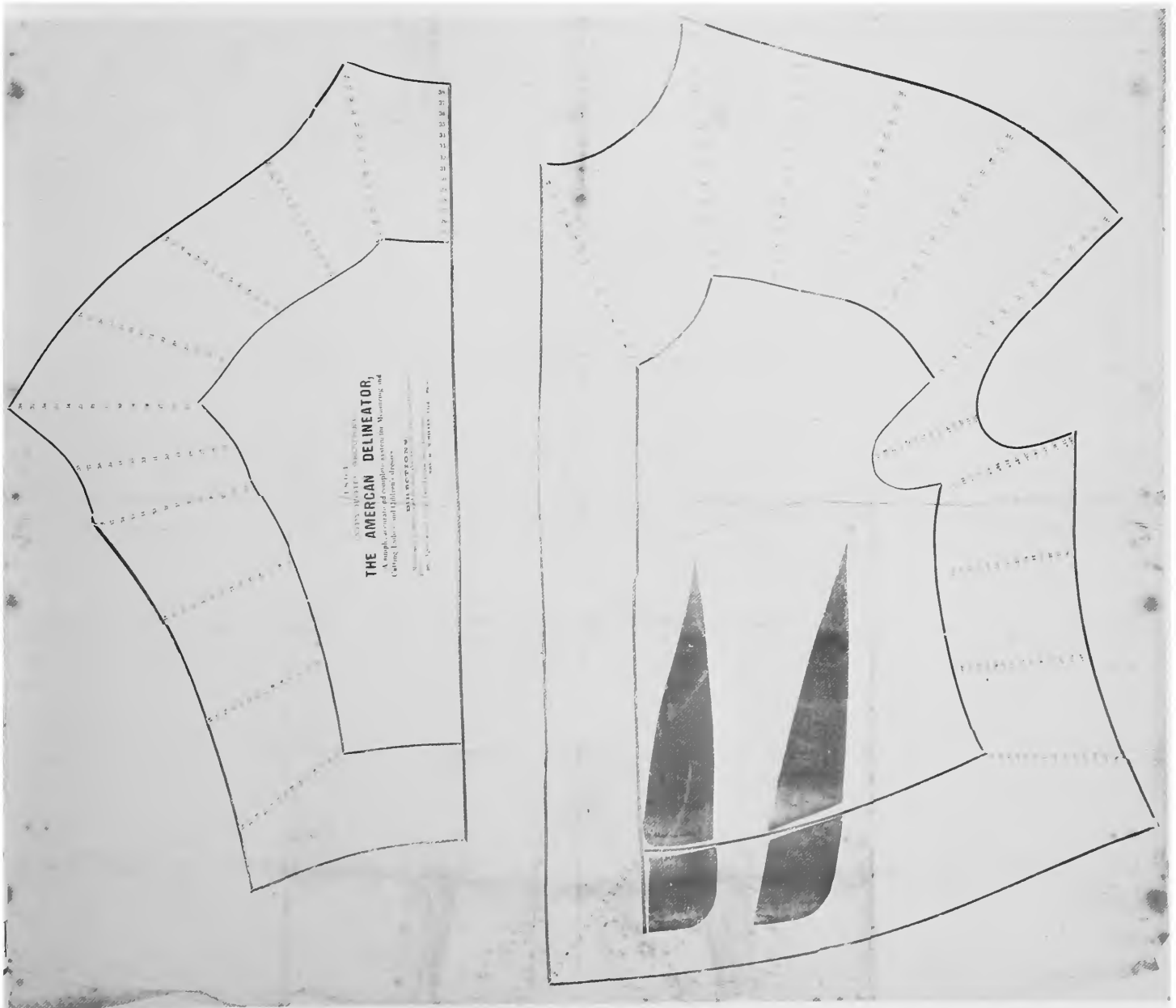

this chart in 1864. In this system it was assumed that the user owned an inch measure of some type. The locations of the drafting points were determined according to the "measurement in inches around the chest, close under the arms" (McMillen, 1864). Patterns could be drafted for women ranging in chest measurement from 24 to 39 inches. This type of measurement was very similar to that used in the pre-Tentler system.

Despite the modifications that each creator of a perforated proportional system devised, these methods had similar advantages and disadvantages. The significant advantage of this type of system was that it was easy to use. It required no calculations, there were no complicated steps, and a garment could be drafted quickly. It was the ease with which these systems could be applied that encouraged their continued use.

The two common weaknesses of these methods, however, encouraged the development of other techniques. First, the perforated proportional system worked well only for a few women. Because they were based on proportional presumptions, these methods could draft garments which would fit well only the few ladies who conformed to the creator's notions regarding proportional figures. The obvious remedy for this problem was to incor-

porate some direct measurements producing hybrid systems using perforated tools. Tentler was ahead of his time when he advised correcting the pattern drafted with his tool according to the underarm length and half the front "breast" measurements. But these modifications were merely added corrections rather than a true integration of direct measurements with proportional procedures.

The second fundamental weakness of the perforated proportional systems is found in the form of the tool. The series of perforations provided fixed points for drafting one style of dress—only one. Thus, when fashions changed and required a bodice of a different cut, the system became obsolete. In the preface of his 1842 publication, Tentler declared that he had "not the least doubt that this little book [would] realize his expectations" (1842:3). I suspect that he was sadly disappointed.

FIGURE 19a,b. Powell & Kohler's proportional system as presented in their 1868 instruction book published in Cincinnati, Ohio. (Library of Congress.)

FIGURE 19a (below). Strip scales printed on a single sheet of paper included in the instruction book.

FIGURE 19b (right). Illustration showing how to use the strip tool to place critical drafting points.

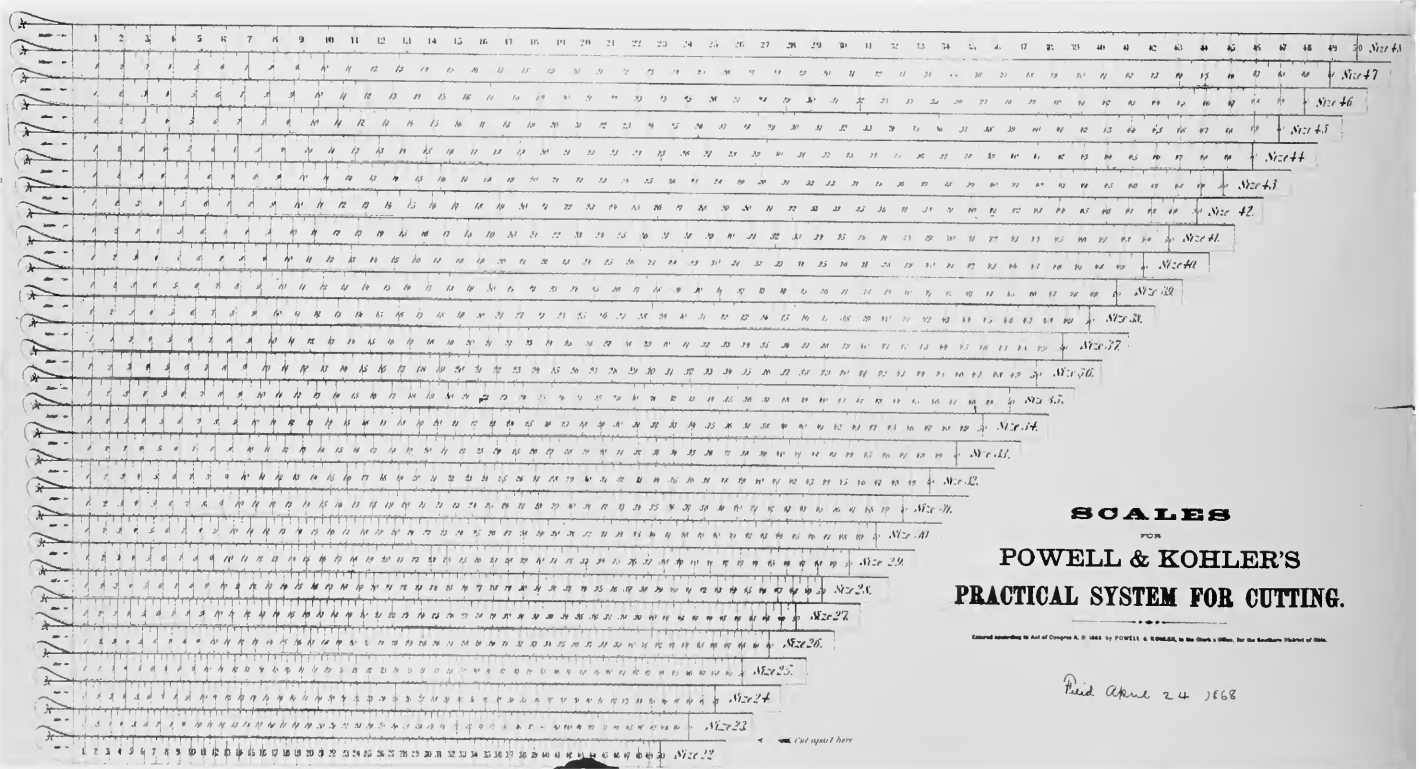

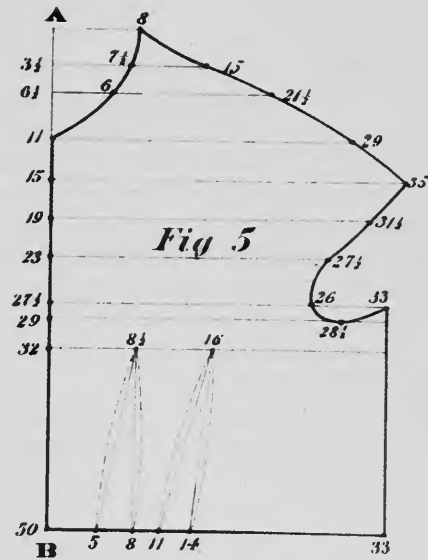
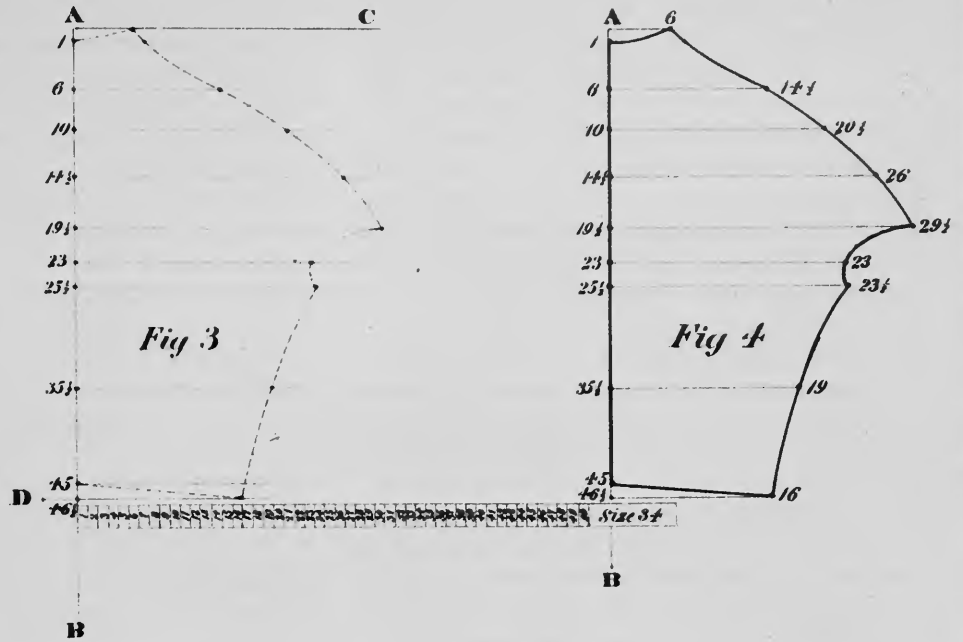
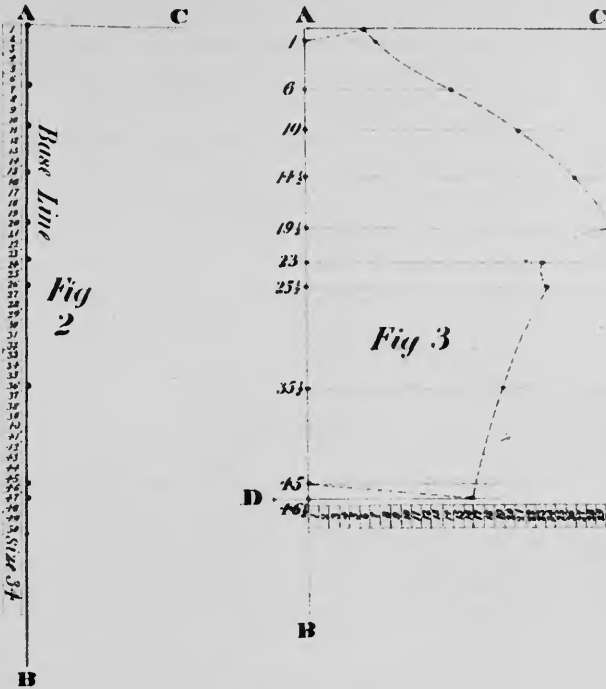

His system had become obsolete even before his patent was granted or his book copyrighted. Changing fashions continued to affect the longevity of individual drafting systems.

In 1868 Powell & Kohler published in Cincinnati, Ohio, a proportional method with a different type of tool. This system used a series of numbered strips, one for each size based on "breast" measurement (22 to 48 inches). These 27 strips, each divided into 50 equal parts, were printed on a single sheet of paper folded into the back of the instruction booklet (Figure 19a). The user was to have pasted this paper onto a stiff pasteboard and then cut the strip-scales apart. The scale to be used was selected according to the breast measurement.

The drafting process with this strip tool was not as simple as using a perforated chart. Nevertheless Powell & Kohler were probably right when they claimed that anyone of ordinary intelligence could learn this system in 15 to 30 minutes. In the authors' example (Figure 19b) the individual had a 34 inch breast measurement. Thus, the scale marked "Size 34" was selected. To start, a vertical base line (A to B) and a shorter horizontal line (A to C) were drawn using the two arms of a common square as a guide. The strip scale was placed next to the vertical base line and dots were then made on this line next to specified numbers on the scale. In the case of the back of a lady's dress, dots were placed at numbers 1, 6, 10, $14\frac{1}{2}$, $19\frac{1}{2}$, 23, $25\frac{1}{2}$, $35\frac{1}{2}$, 45, and $46\frac{1}{2}$. A horizontal line was drawn from each of these dots perpendicular to the vertical base line. The scale was then placed on each horizontal line and a dot marked on this line next to a specified number on the scale. For example, the horizontal line at point one was dotted at six on the scale. The next horizontal line at point six was dotted at $14\frac{1}{2}$. The third horizontal line at point 10 was dotted at $20\frac{1}{2}$ and so on until the outline of the bodice piece was formed by a series of dots. The drafter connected the dots free hand. The numbers of the dots remained the same vertically and horizontally for each pattern piece no matter what the size of the individual. The eventual size of the garment depended upon the scale that was used, which in turn was determined by the breast measurement.

Powell & Kohler's method had disadvantages similar to the perforated proportional systems,

namely, not being very successful in drafting garments that fit well and becoming obsolete as fashions changed. The authors attempted to eliminate these disadvantages through two strategies. To draft a more accurately fitted garment, the Powell & Kohler method instructed the dressmaker to take two more measurements in addition to the breast measurement. These extra measurements (waist and underarm length) were not an intrinsic part of these systems but were to be used to "proof" or check the pattern once it was drafted. If there was a discrepancy between these direct measurements and the pattern, the pattern was to be altered. Powell & Kohler also attempted to prevent their method from becoming obsolete due to fashion changes. They intended to publish annual supplementary editions which would guide the subscriber in the art of cutting the most current styles with their system. As they told their readers,

this will enable all to keep up with, or rather in advance of the most popular styles, at a much less expense than by taking costly magazines, which after all do not teach you how to cut, but leave you to work out the problem for yourselves or to go to a professional cutter, at an annual cost of perhaps twice the price of our "system" (1868:20).

Powell & Kohler's proportional system utilizing strips and the proportional methods using perforated charts may have had a common origin. It is obvious to me that the concept behind the graduated strips, used to mark points on perpendicular base lines in the draft, was derived from the divided strips integral to Wilson's 1827 tailors' system (Figure 6). As reported before, this was a modification of the tailors' system published in England by Minister in 1822. It has occurred to me that the perforated proportional tools might also have the same lineage. For if the Powell & Kohler strips were used to mark the drafting points for all the possible sizes on the same sheet of paper the spread of drafting points would look very much like the perforated tools we have been examining. Thus it is my opinion that it was the perforated form of this kind of tool that was uniquely an American creation. It was the simplest to use and its simplicity ensured its continuance in future hybrid systems.



Hybrid Systems

Both Tentler and Powell & Kohler recommended using several direct measurements to correct the patterns drafted by their proportional systems. Others felt that the failings of proportional methods were too great to be corrected after the fact. These individuals created new systems by hybridizing proportional methods with direct measurements. They wanted to create methods that had the best features of both—the simplicity of proportional methods and the greater accuracy of direct-measure techniques. Thus the majority of dressmakers' drafting systems that purported to be proportional were really hybrid methods.

Hybrid systems could differ from each other in all the ways that the proportional systems varied. They could also differ as to the number and kinds of direct measurements used and how these dimensions were integrated with the proportional methods. The forms of the tools also took on greater variety as new features were added.

At first glance, "The American Dress Chart" published in 1868 in Danville, Indiana, by Cox & Minton (Figure 20) might be confused with the proportional systems. Like many of the earlier systems, the single sheet of paper was a "perforated" tool that required the user to make the holes for marking the drafting points. It was, however, one of the simplest and most obvious examples of a hybrid method. The "breast" measure designated the prescribed drafting points determining all breadth dimensions including the width of the shoulders and the circumference of the neck. The underarm length measurement of the woman, however, determined the underarm dimension of her garment. The drafting point for this measurement, ranging from six to nine inches measured to the nearest quarter inch, was marked through the designated circle. The lengths of the center front and center back, however, were not determined by direct measurements. These dimensions were affected both by proportions determined by the "breast" measurement in the neck area and by the underarm measurement which dictated the location of the waistline.

Significantly, none of the previously mentioned drafting tools helped with drawing the curves of the pattern outline. The absence of curved-edge guides was common both to the dressmakers' sys-

tems and most of the more numerous tailors' methods. Nevertheless, tools to aid the drawing of the curved lines had been used earlier in other trades, particularly for complex curves or those of larger radii than could be conveniently drafted with a compass. Probably the earliest examples of these specialized aids were the sets of curves made of thin wood by a ship designer to fit his individual requirements (Chappelle, 1967:20). By about the mid-19th century "French" or "irregular" curves, continually varying in degree of curvature, were being offered in catalogs of mathematical, drawing, and measuring instruments (McAllister & Brother, 1855:43).

Like the early ship designers who used home-made curves, some tailors probably devised their own curves. In fact, the patterns developed by many 18th century tailors fulfilled the purpose of a set of curves. Also, Giles reported that some early tailors, finding the armscye to be the most difficult part to draft, resorted to using various sized horse-shoes as drawing aids. Or an even simpler technique was to place the left hand on the cloth with the fingers and thumb spread widely and then draw the armscye with chalk following the circular outline established by the fingertips (Giles, 1887:89).

Nevertheless, most of the early 19th century instruction booklets¹³ published in the United States, commonly directed tailors merely to "cast," "sweep," or "strike" a curve. An 1822 booklet said this should be done "with a pair of compasses, or with a thread" (Jones, 1822:12). Sweeping a curve was done in two ways depending upon the drafting procedure: either by establishing an external "centre" or "pivot" or by specifying the length of the radius. An example of the latter is an 1842 direction to "sweep the side and shoulder seams by the length of the waist" (Williams, 1842:4). These techniques were included regularly in American publications on tailoring as late as the 1860s.

Tailors who did not use any of the above techniques or curved tools drew the curves freehand. They developed a "compass in the eye" as was expected of the students of early 19th century

¹³ I have examined about 30 tailors' instruction booklets dating from 1809 to 1871.

drawing manuals (Marzio, 1976:31).

Commercially produced curves were probably used by some tailors when they were manufactured for other trades. In 1849 the New York magazine for tailors, the *Mirror of Fashion*, listed for sale a "Curved Ruler" for 50 cents (1849:16). This tool stands out among the variety of squares and scales that were offered. In 1861 Joseph H. Noland re-

ceived a copyright for a printed sheet of paper which included both diagrams and instructions for his hybrid drafting system for tailors. The directions specified which section of a "Developing Pattern" or curve to use to draw a particular portion of a pattern. Two curves were illustrated in miniature, "Developing Pattern no 2" and "Developing Pattern no 7." They were shaped very much like

FIGURE 20. Tool (intended to be perforated) printed on a sheet of paper, 66.2 x 57.0 cm, for the 1868 hybrid system of Cox and Minton of Danville, Indiana. (Prints and Photographs Division, Library of Congress.)

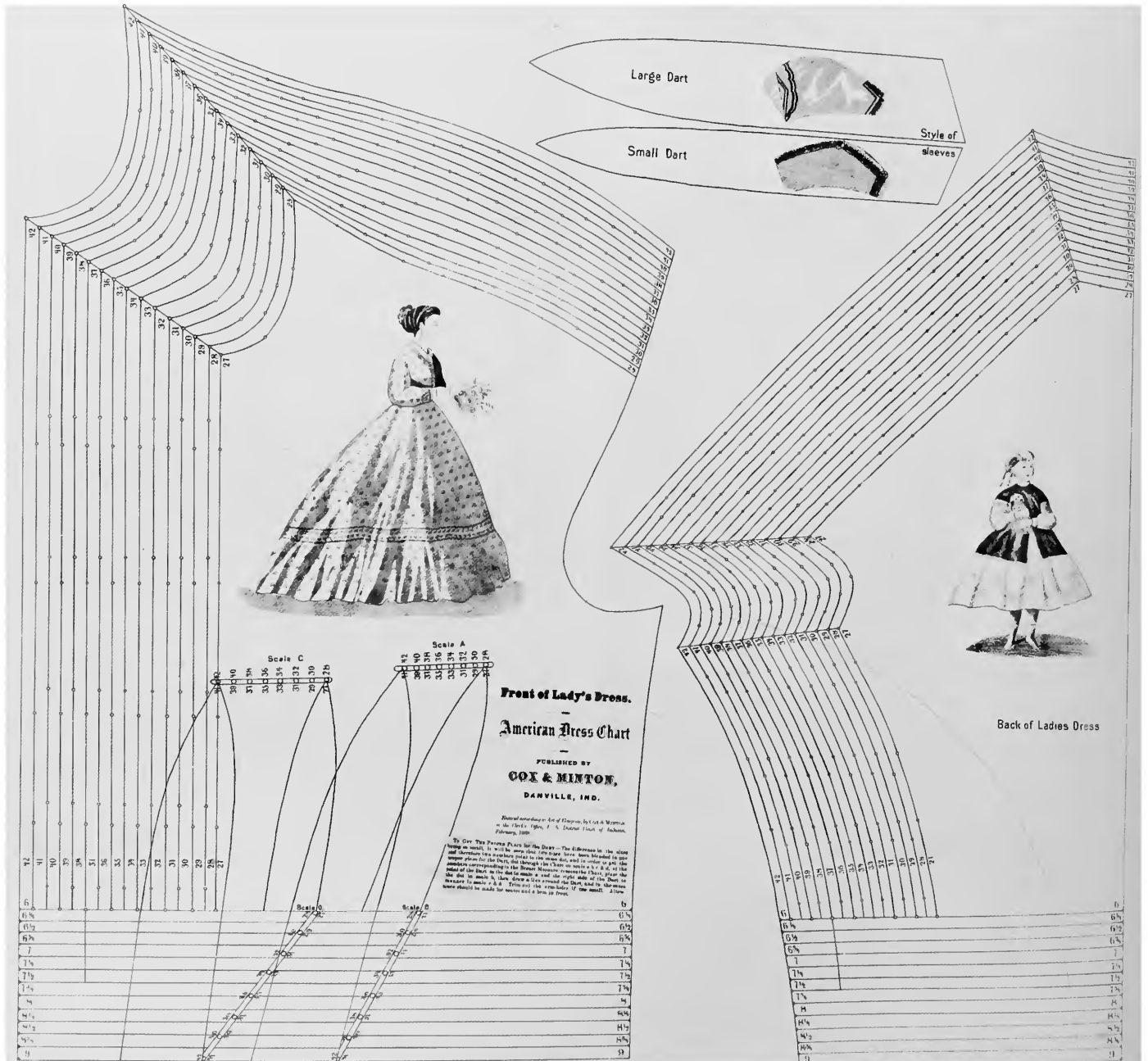

curves sold in large sets for ship designers and similar trades. I suspect that the two “developing patterns” Noland depicted were from a large, manufactured set.

Dressmakers’ systems of the first half of the 19th century did not include tools with curved edges to help with drawing. Nor were dressmakers commonly directed to sweep a curve.¹⁴ Instead, they were instructed to connect the drafting points, freehand, using as a visual reference the outline printed on the tool or in the directions.

In the last half of the 19th century, however, curved edges became an increasingly important feature of dressmakers’ drafting tools. The earliest example I found was James H. Chappell’s perforated tool for a hybrid system located in the Prints and Photographs Division of the Library of Congress (Appendix II). Chappell received a copyright on 28 December 1853 for this dressmakers’ tool, which was printed on a rectangular piece of paper. Previously, Chappell had created drafting systems for tailors. He was granted a patent on 18 January 1834 for a technique he called the “spherical system of drafting and cutting garments” with an “elastic square” (U.S. Patent 7,962X). In 1839 he published an instruction booklet for *The Patent Transfer System*. In this publication he instructed tailors to sweep most of the curves of a man’s coat. Fourteen years later, however, Chappell did not incorporate this common tailors’ technique in his system for dressmakers. Instead he intended for the back, neck, and side pieces to be cut apart and used separately and he instructed the dressmaker to “mark the curves by the edge of the piece as by the edge of a rule, or scribe” (Chappell, 1853). The way he explained how to use the curved edges suggests that it was a relatively new technique. Or, at least, he did not expect all dressmakers to understand readily the purpose of the curved edges.

C. E. Mosher’s 1873 “Bon Ton Dress Chart” manufactured in Lawrence, Massachusetts, was a hybrid system requiring a tool with specifically curved edges to help draw some of the lines for the draft of a bodice (Figure 21). The two-piece tool

was printed on thin cardboard, perforated, and cut out when it was manufactured. The “bust” measure proportionally dictated the dimensions of the shoulder, neck, and armhole. Direct measurements dictated the distance from the “neck to the hollow on the shoulder,” the waist, and the “length of waist.” This last measurement was the length of the body to the waist under the arm. The dimensions of the bust darts or “biases” were determined by taking the difference between a “loose measure around the most prominent part of the bust, close up under the arms” and a “tight measure around the chest above the bust, below the shoulder blades.” This difference identified which holes on the tool’s “bias scales” would be marked to determine the size and location of the bust darts.

The Mosher tool also incorporated a technique that was sometimes used for apportioning a direct measurement. Together, the “back waist measure” and the “front waist measure,” near the bottom straight edge marked in inches, formed an apportioning scale. The purpose of an apportioning scale was to save the user from having to do any figuring. The scales predetermined how much of a direct body measurement would be covered by which piece of the garment. For example, in the Mosher tool the dressmaker marked through the hole¹⁵ marked “26” on the “front waist measure” scale to designate how much of a 26-inch waist was covered by the front. The “back waist measure” scale allotted the amount for the back of the dress in the same manner.

The 1890 Markley & Son system from Topeka, Kansas, was similar to Mosher’s in certain fundamental ways. It also was a hybrid system for which the “bust” measure proportionally determined all breadth dimensions except the waist and it used a perforated tool with curved edges (Figure 22). Although it was also used in a similar manner, there were differences. For example, after the proportionally determined drafting points were marked for the upper part of the dress front, the tool was moved again and again so that each of the appropriately curved edges were used as a guide for drawing the designated curved lines between the points. In the Markley & Son tool there were specific curves to help draw every line, not just a few. Then, following a set series of steps (carefully

¹⁴ Zabina Holbrook’s 1870 hybrid system with a perforated tool was an unusual exception. The dressmaker was directed to “place the right hand at the front of the neck, and with the left sweep the point, or lower part of the forepart, from the bottom of the side seam. The length of point may be altered according to fashion or taste” (Holbrook & Co., 1870).

¹⁵ The holes were not punched in the extant example (Figure 21).

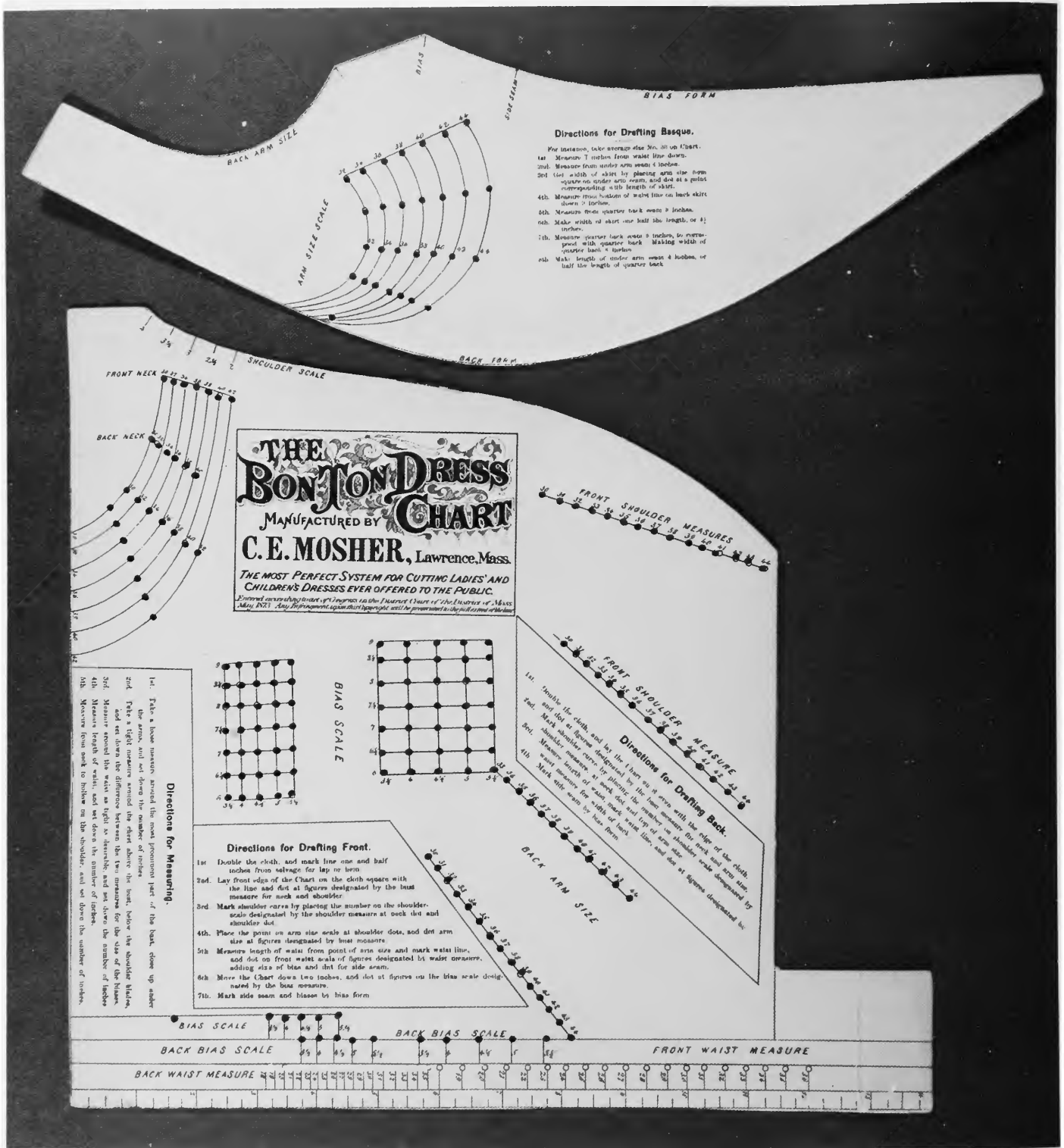

FIGURE 21. The two-piece perforated and curved tool printed on cardboard for the hybrid system of C. E. Mosher of Lawrence, Massachusetts. (Smithsonian Institution.)

described in a well written instruction booklet), the length dimensions were established using direct measurements. But, in addition to the length of the underarm (marked through the perforated grids on the front and back pieces), the lengths of the center front and center back were prescribed by direct measurements, determined on the draft using the curved center front and center back edges of the tool that were also marked in inches.

In the Markley & Son system the bust darts and underarm darts were determined by first finding the “taper” or difference between the bust and the waist measurement. The “taper scale” yielded a number that, when used to mark the drafting points, allotted a predetermined portion of the taper to each of the six darts (or four if a “half-fitting” garment was desired).

More than anything else, the differences between the Markley & Son system and the Mosher system were the result of changed fashions. The closer fitting fashionable style of the early 1890s demanded a greater number and more exact use of direct measurements. It also required specific, complexly curved outlines for each pattern piece. Also the addition of a vertical underarm dart helped to achieve a closer fit than was possible in the Mosher method. (In one type of bodice design of the mid-19th century there was no underarm seam: the bodice front extended under the arm to a side-back seam.) Although the Markley & Son system produced a “glove-fitting” garment, the cut was not the most stylish. It was more fashionably precise to use four pattern pieces for a dress bodice—front, underarm, side-back, and back—rather than just a front and back.

The separate Markley & Son sleeve system (Figure 23) used four direct measurements and did not incorporate any proportionally dictated dimensions. In this tool, the perforated grids were apportioning scales that allotted circumference measurements to the two pieces of the sleeve.

John B. Plant was living in Pawtucket, Rhode Island, when he was granted a patent for a “Dress Chart” on 27 November 1900 (U.S. Patent 662,817). At that time his hybrid system used a five-piece adjustable and perforated tool for drafting an entire dress. Four pieces were to be drafted for the “waist”—front, underarm, side-back, and back—and, significantly, one piece for the skirt.

In the early 1890s skirts of fashionable dresses were shorn of drapery and cut to fit smoothly over

the hips. When this change occurred, drafting tools for cutting skirts were created. As fashions in the first eight years of the 20th century dictated even closer fitting skirts to emphasize an amply proportioned *derrière*, skirt systems appeared regularly, either as part of a dress cutting technique or by themselves (see Appendix III).

John Plant was living in Biddeford, Maine, when in about 1904 he produced the tools bearing his name that are now in the Smithsonian Institution. The “Professor” (as he called himself) hoped to sell to customers in both Canada and in the United States. The directions on these tools were printed in French as well as in English. Plant’s “Dress Cutting Machine” included the four pieces (Figure 24a) for drafting the dress bodice described in his patent. The “bust” measurement, ranging from 28 to 48 inches, proportionally determined the upper dimensions around the neck, shoulder, and armhole through numbered perforations. Waist measurements from 20 to 38 inches were apportioned by the perforations in the waist area. And the vertical measurements of the front, underarm, and back dictated to what length the related portions of the tool should be adjusted. After the tool was adjusted, it was placed on the fabric or pattern paper and the drafting dots made. Then the tool was moved to use the curved edges to draw the lines between the dots.

Plant’s hybrid skirt system (Figure 25) had a different form from the instrument covered in the 1900 patent. There is no reference to any other patent on the tool. This one-piece device was used to draft a gored skirt with three pieces—front, side, and back. The waist measurement was apportioned by the scales printed at the waist edge, while the waist measurement proportionally determined the width of the front and back pieces. The width of the side piece (midway between waist and hem) was defined according to “the width of skirt you desire.” The lengths of all three patterns were dictated by the three length measurements. Again the various curves on the tool were used for drafting.

Professor Plant’s sleeve system (Figure 26) was a direct-measure method using one adjustable tool to draft the two sleeve pattern pieces. The tool was adjusted directly according to the measurements from wrist to elbow and from elbow to armhole. The circumference of the wrist, elbow, and armhole were apportioned by adjustable scales at the

FIGURE 22a-c. Neatly perforated, precisely curved pieces of the 1890 hybrid system tool printed on cardboard for Markley & Son, Topeka, Kansas. (Courtesy of Sydney Brooks.)

FIGURE 22a (below, left). Bodice front.

FIGURE 22b (below, right). "Dart Rule," combining a straight edge with an irregular curve.

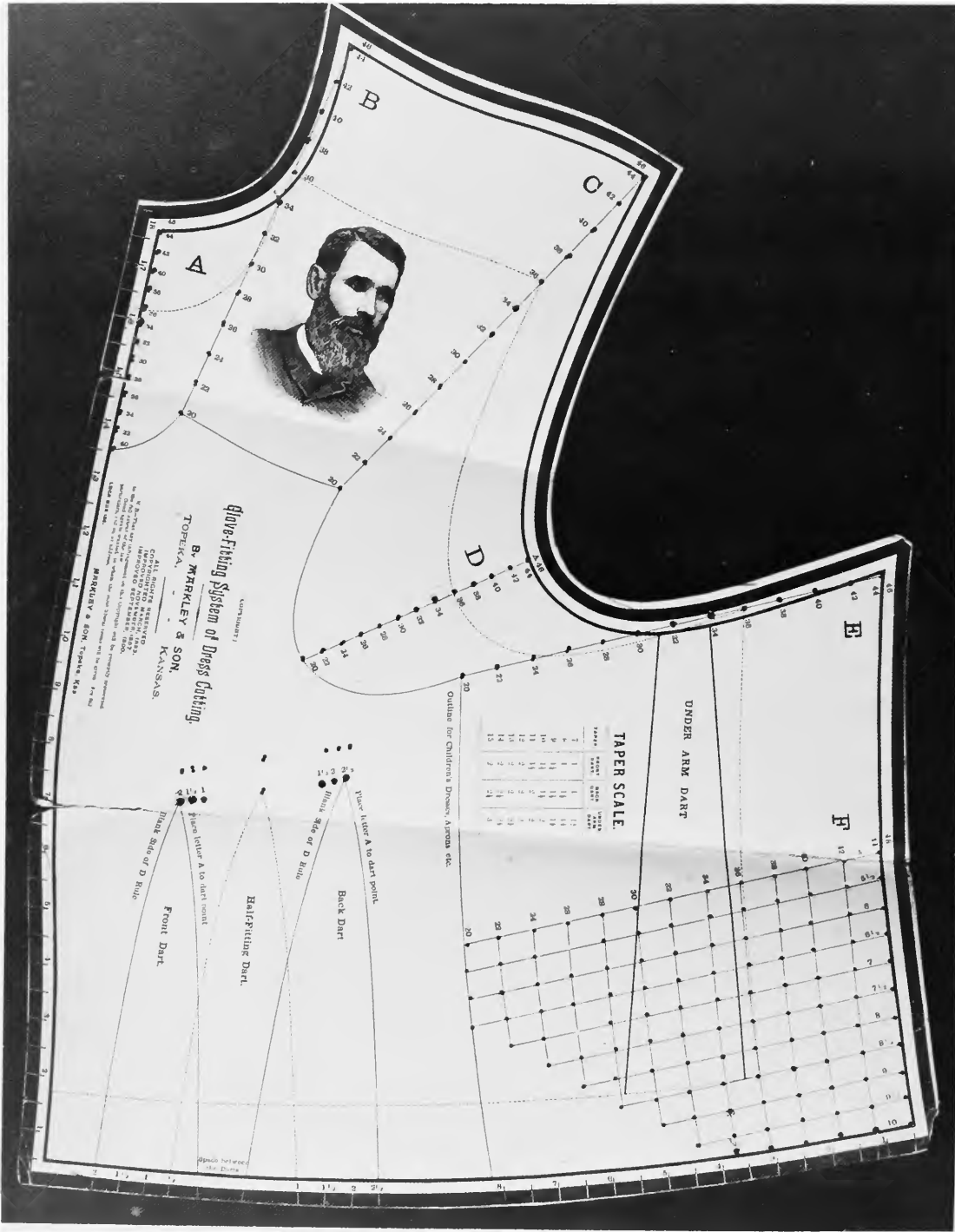

FIGURE 22c. Bodice back.

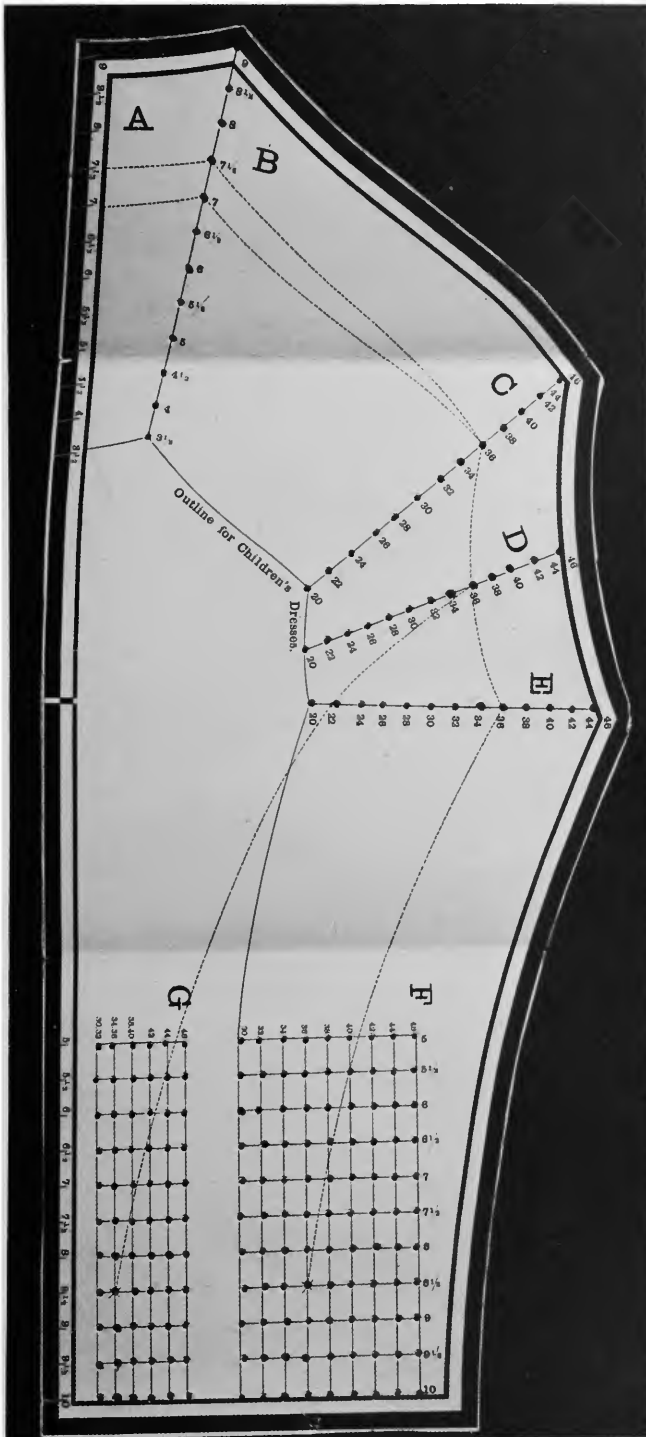
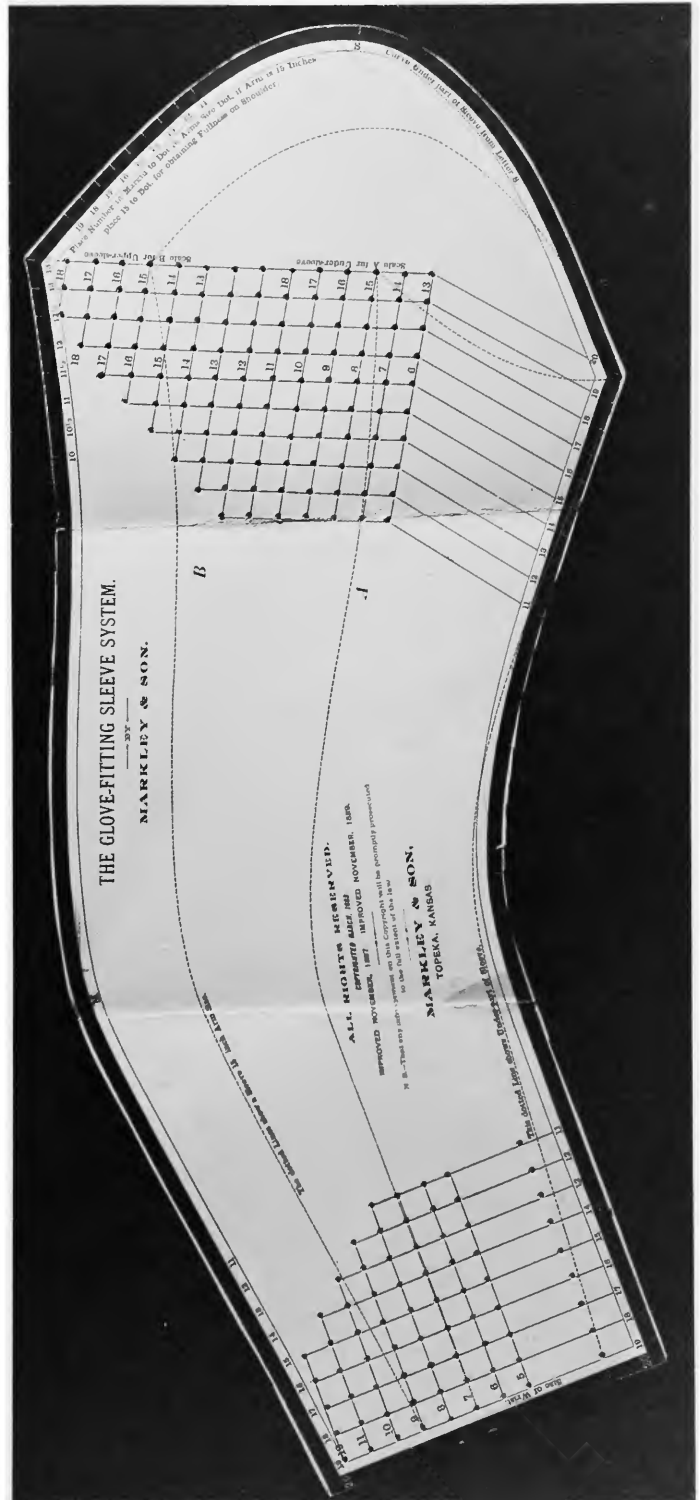

FIGURE 23. Perforated tool printed on cardboard used for Markley & Son's 1890 direct-measure system for drafting sleeves. (Courtesy of Sydney Brooks.)



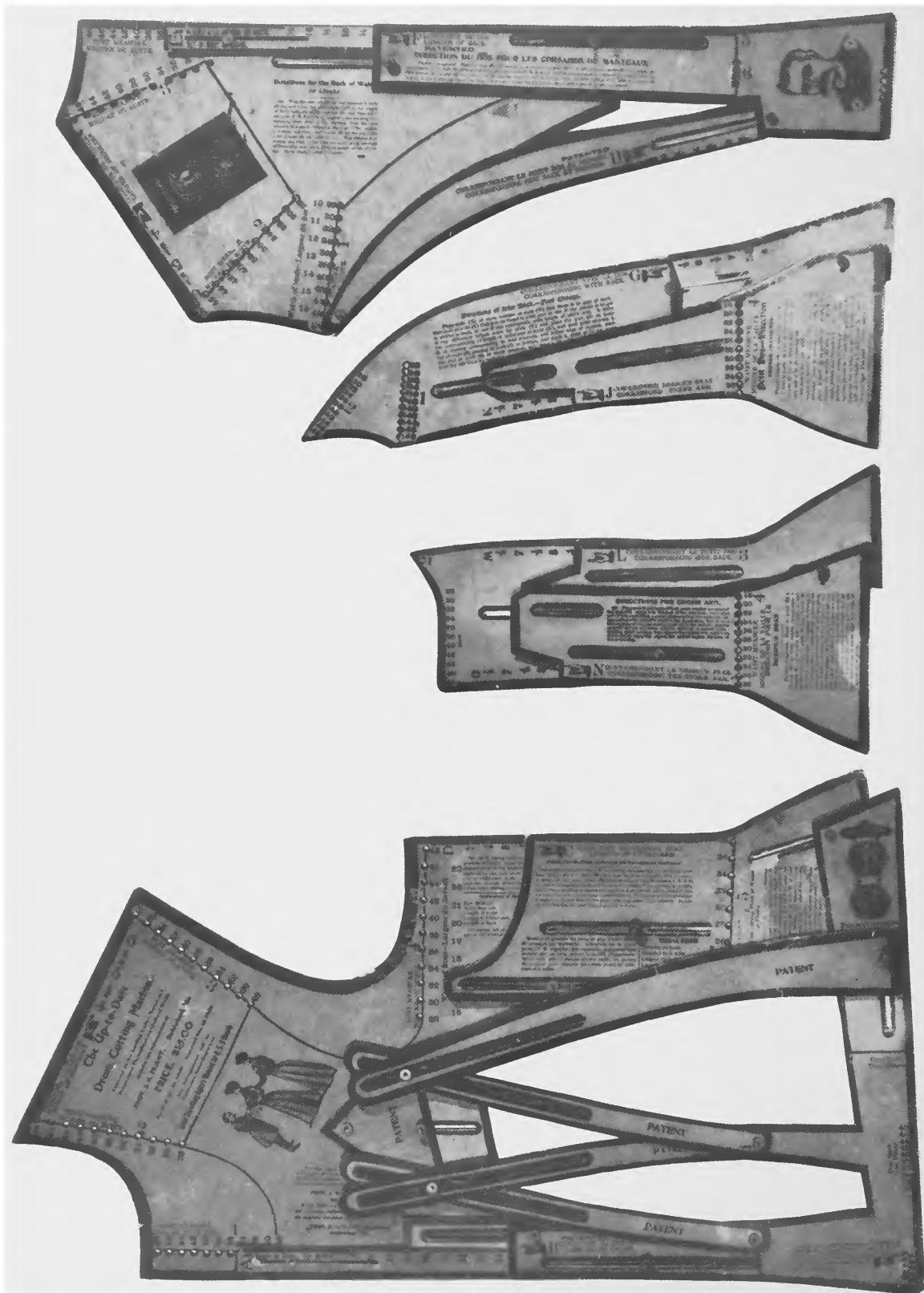



FIGURE 24a,b. "Dress Cutting Machine" offered in 1904 by Professor J. B. Plant of Biddeford, Maine, for \$15. (Smithsonian Institution.)

FIGURE 24a (left). The four-piece, perforated, adjustable cardboard tool for Plant's hybrid system of drafting a dress bodice.

FIGURE 24b (above). Detail of front piece showing Professor Plant at work. The bust measurement was one of the most important dimensions in a hybrid system. Note the perforations in the tool reinforced by metal rings.

corresponding sections of the tool.

In addition to these methods, Professor Plant sold a "Children's System" for \$2.50, which included a hybrid technique for cutting the bodice with a two-piece adjustable perforated tool and a direct-measure method for drafting sleeves with a two-piece perforated tool. Also, for \$2.00, he sold a hybrid system with a one-piece perforated tool for cutting capes, as well as assorted cardboard patterns—some perforated—for a variety of collar styles, ranging in price from \$0.30 to \$0.75.

Professor John B. Plant's work was probably carried on by a relative, Harry N. Plant, also of Biddeford, Maine, who was granted patents on 14 February 1905 and 20 March 1906. They appear

to have covered improvements on the Professor's earlier efforts. The four-piece tool for drafting a bodice was made to adjust in width as well as length so that a garment could be cut entirely from direct measurements (U.S. Patent 782,415). By similarly changing the skirt drafting tool this cutting technique was also converted from a hybrid system to a direct-measure method (U.S. Patent 815,467).

In New York City, the Vienna Ladies' Tailoring Institute published a hybrid system. Although earlier instruction books bearing the name of the Institute exist, the tool illustrated was part of a system dating from about 1905. This hybrid method had only one proportionally determined dimension, the breadth of the shoulders. This was prescribed from the "bust" measurement by the "Proportionate Shoulder Measure" scale printed on the tool. Other dimensions were determined directly using seven measurements: "bust," waist, front, center back length, center front length, underarm length, circumference of neck, and "arm's eye."¹⁶ The system used both sides of an irregularly curved cardboard tool (Figure 27a) and a square, marked in inches. Starting from two perpendicular lines a pattern piece was developed following a carefully established series of steps involving measuring, dotting, and drawing (Figure 27b). The front and back neck scales printed on the tool were apportioning scales. The letters on the tool helped the user locate and place the right section of a curve for drawing. For example, to define the curved neck edge ("line C") on the front, letter "C" on the tool was placed on "dot X" of the draft. The tool was then pivoted until the left edge of the curve hit "dot 3." Then the line was drawn. This technique of using letters to designate critical points on a curved drafting tool appears in other systems.

No doubt the Vienna Institute technique drafted a better fitting garment than the previously described methods, but it also was not as easy. That was the critical "trade off." The more direct measurements used in a hybrid system, the more accurate it was, but the more complicated to use.

The dress cutting method advocated by Samuel T. Taylor of New York City was a hybrid system using proportional strips. Taylor claimed to have first of-

¹⁶ The "arm's eye" measurement was taken around the arm just over the point of the shoulder.

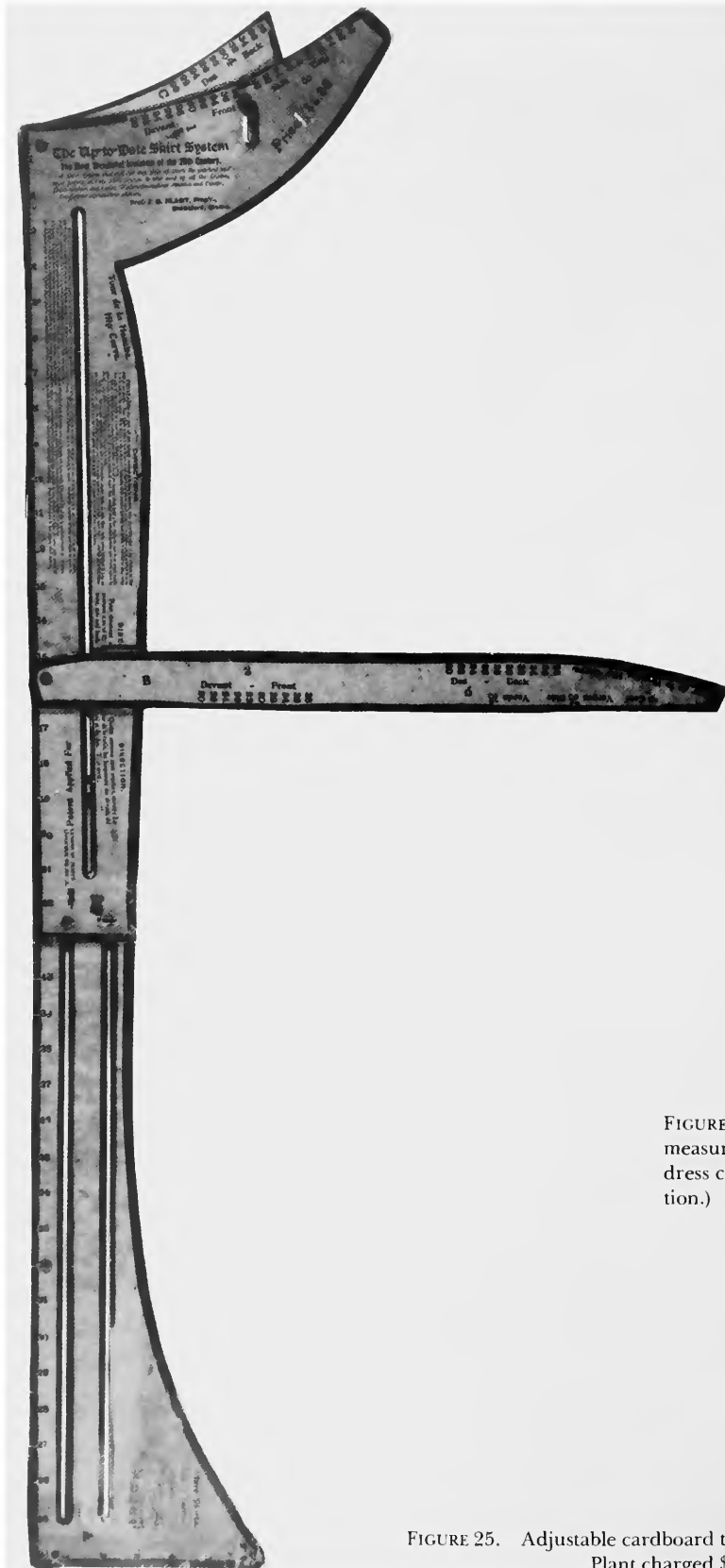

FIGURE 25. Adjustable cardboard tool for a hybrid skirt drafting system for which Professor Plant charged \$5 in 1904. (Smithsonian Institution.)



FIGURE 26. Adjustable cardboard tool for Plant's direct-measure system of drafting sleeves, which could be added to the dress cutting system for an additional \$5. (Smithsonian Institution.)

ferred his drafting system to the public in 1848 (Taylor, 1896:23), and a variation of this same system was published as late as 1919 by the S. T. Taylor Co. The longevity of this technique was extraordinary, a phenomenon that can be explained only by the flexibility of the drafting process, the diversification of the S. T. Taylor Co. enterprises, and the forcefulness of Taylor's personality.

In spite of the remarkably long use of Taylor's system, I have not located an extant drafting tool for it. I have determined the form of the tool, however, from the evidence in several instruction booklets (Figures 28, 29). Although the drafting process was modified, the tool was not changed. The system required proportional strips similar to those used by the later Powell & Kohler method (Figure 19a). One strip was selected according to the "breast" measurement and attached to the long arm of a square. The second strip was selected according to the waist measurement and was attached to the short arm. The 16 divisions on each strip were used to determine critical drafting points along with certain direct measurements. The number and identity of these measurements and the way they were incorporated into the drafting process varied from one set of instructions to the next. The instructions were modified as fashions changed, as a better way was discovered, or in response to complaints.

Dr. Minier, who was in the middle of a violent verbal duel with Taylor, wrote in 1857:

The thing . . . falsely called S. T. Taylor's System for Dress-cutting is not his, and never was; neither is it a system of dress-cutting at all; but a system for drafting men's attire; adapted to a man's figure, and not a female's . . . it is known as the Old Square Scale and Slide System invented about forty or fifty years ago . . ." (Minier, 1857:5).

Minier was not an impartial reporter. Nevertheless, most of this statement concerning the origins of Taylor's method is credible. Being a "Practical Tailor" (*Le Bon Ton*, Jul 1857: inside front cover) Samuel T. Taylor probably modified an existing tailors' system to cut dresses. Wilson's 1827 hybrid system with proportional strips clamped on the arms of a square (Figure 6) was probably the prototype.

Regardless of Dr. Minier's intended criticism, Taylor made the old system work for women's garments. By adding direct measurements to the drafting process, Taylor made his system more effective than the proportional charts or models.

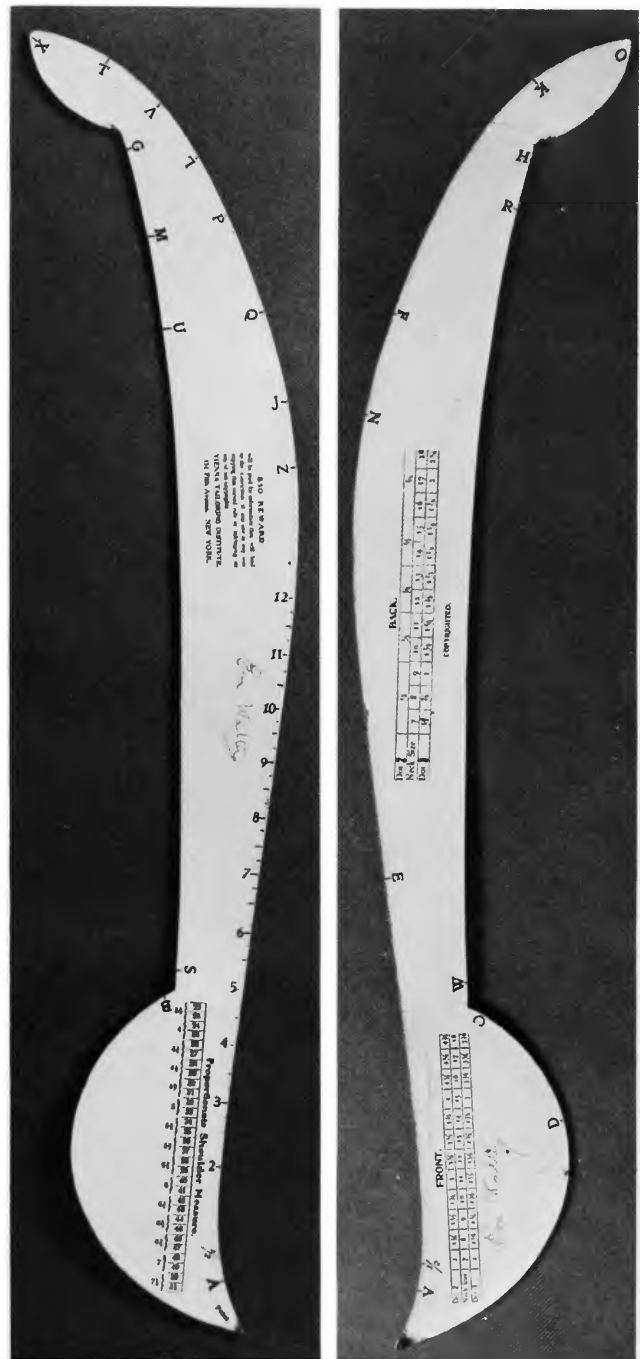
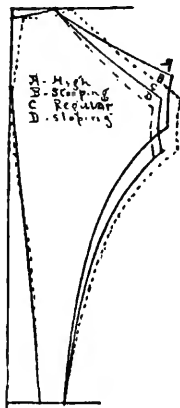
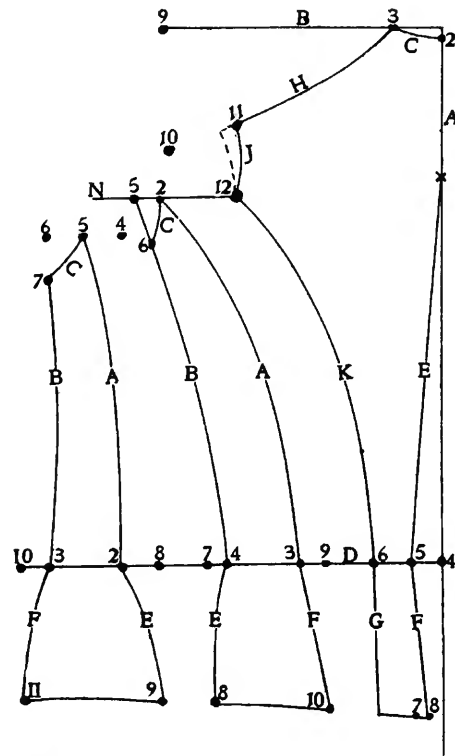

FIGURE 27a-c. Tool and detailed diagrams and instructions that had to be followed closely to draft a basic dress bodice using the hybrid system issued about 1905 by the Vienna Ladies' Tailoring Institute, New York. (Smithsonian Institution.)

FIGURE 27a. Obverse and reverse of the curved cardboard tool printed on both sides.



For long shoulders draft line H $\frac{3}{4}$ inch longer than the proportionate shoulder measure and place dot 11. Measure straight down from dot 11 and $\frac{3}{8}$ inch in and place dot 12. Use letter V to draft line K.

Bust	-----	34
Waist	-----	22
Front	-----	15
Back	-----	15
Underarm	-----	8
Neck	-----	11
Arm's Eye	-----	16

To locate dot 12.

ARM'S EYE MEASURE.

12, 13 and 14	—	$1\frac{3}{4}$ inches.
15	“	16—2 “
17	“	18— $2\frac{1}{4}$ “
19	“	20— $2\frac{1}{2}$ “
21	“	22— $2\frac{3}{4}$ “

CENTER BACK.

- 1 Draft lines A and B $\frac{3}{4}$ inch from the edge and end of cloth,
- 2 Measure the distance given in the neck table according to size of neck under dot 2, down line A from line B and place dot 2.

NECK TABLE.

Dot 2	$\frac{3}{8}$	$\frac{1}{2}$	$\frac{5}{8}$	$\frac{3}{4}$	$\frac{7}{8}$	1	1 $\frac{1}{8}$	1 $\frac{1}{4}$	1 $\frac{1}{2}$	1 $\frac{3}{8}$	1 $\frac{3}{4}$	1 $\frac{7}{8}$	2	2 $\frac{1}{8}$
Neck Size	7	8	9	10	11	12	13	14	15	16	17	18		
Dot 3	$\frac{3}{4}$	$\frac{7}{8}$	1	1 $\frac{1}{8}$	1 $\frac{1}{4}$	1 $\frac{3}{8}$	1 $\frac{1}{2}$	1 $\frac{5}{8}$	1 $\frac{3}{4}$	1 $\frac{7}{8}$	2	2 $\frac{1}{8}$		

- 3 Measure the distance given in the neck table under dot 3 on line B from line A and place dot 3.
 - 4 Place the point of curve on dot 2 and draft line C to dot 3.
 - 5 Measure down line A from dot 2 the length of back measure and place dot 4.
 - 6 Draft line D straight out from dot 4 about 5 inches.
 - 7 Measure one inch from dot 4 on line D and place dot 5.
 - 8 Measure the distance from dot 5 that the table gives for the width of center back and place dot 6.
 - 9 Draft line E beginning 4 inches below line B and draft to dot 5.
 - 10 Measure 5 inches straight down from dot 5 and place dot 7.
 - 11 Measure $\frac{1}{2}$ inch in towards line A from dot 7 and place dot 8.
 - 12 Draft line F from dot 5 to dot 8.
 - 13 Measure $6\frac{1}{2}$ inches on line B from dot 3 and place dot 9.
 - 14 Measure 4 inches straight down from dot 9 and place dot 10.
 - 15 Place letter A on dot 3, the edge of curve on dot 10 and draft line H the proportionate length of shoulder and place dot 11. See table on curve.
 - 16 Measure 2 inches straight down from dot 11 and place dot 12.
 - 17 Place the point of curve on dot 11 and draft line J to dot 12.
 - 18 Place letter L on dot 12 and draft line K to dot 6.
 - 19 Draft line G 5 inches straight down from dot 6.
- For high or low shoulder, change the position of dot 10 up or down.
For very high shoulder dot 10 should be only from 2 to 3 inches from dot 9.

SIDE FORM.

- 1 Place the long arm of square on line A in the back drafting the short arm on dot 12 and draft line N straight out from dot 12.
- 2 Measure $2\frac{1}{2}$ inches out from dot 12 and place dot 2 on line N.
- 3 Measure $2\frac{1}{2}$ inches from dot 6 on line D and place dot 3.
- 4 Place letter L on dot 2 and draft line A to dot 3.
- 5 Measure the distance given in the table for the width of side body from dot 3 and place dot 4.
- 6 Measure $\frac{3}{4}$ inch from dot 2 on line N and place dot 5.
- 7 Place letter H on dot 4 and draft line B to dot 5.
- 8 Measure $1\frac{1}{2}$ inches down line B from dot 5 and place dot 6.
- 9 Place the point of curve on dot 2 and draft line C to dot 6.
- 10 Measure $\frac{1}{2}$ inch out from dot 4 and place dot 7.
- 11 Measure 5 inches straight down from dot 7 and place dot 8.
- 12 Place letter A on dot 4 and draft line E to dot 8.
- 13 Measure 1 inch in from dot 3 and place dot 9.
- 14 Measure 5 inches straight down from dot 9 and place dot 10.
- 15 Draft line F from dot 3 to dot 10.

UNDER ARM FORM.

- 1 Measure 3 inches from dot 4 (in side form) and place dot 2.
- 2 Measure out from dot 2 the width of the under arm form as given in the table and place dot 3.
- 3 Measure the distance between dots 4 and 6 in the side form and then measure that distance straight up from dot 2 and place dot 4.
- 4 Measure $1\frac{1}{4}$ inches straight out from dot 4 and place dot 5.
- 5 Measure straight out from dot 4 the width of under arm form and place dot 6.
- 6 Place the corner of square on dot 3, the edge on dot 6 and measure up from dot 3 the length of under arm measure and place dot 7.
- 7 Place letter Q on dot 5 and draft line A to dot 2.
- 8 Place letter M on dot 7 and draft line B to dot 3.
- 9 Place the point of curve on dot 5 and draft line C to dot 7.
- 10 Measure $1\frac{1}{2}$ inches in from dot 2 and place dot 8.
- 11 Measure 5 inches straight down from dot 8 and place dot 9.
- 12 Place letter A on dot 2 and draft line E to dot 9.
- 13 Measure one inch out from dot 3 and place dot 10.
- 14 Measure 5 inches straight down from dot 10 and place dot 11.
- 15 Place letter A on dot 3 and draft line F to dot 11.

FIGURE 27b. Instructions for drafting back, side-back, and underarm pattern pieces.

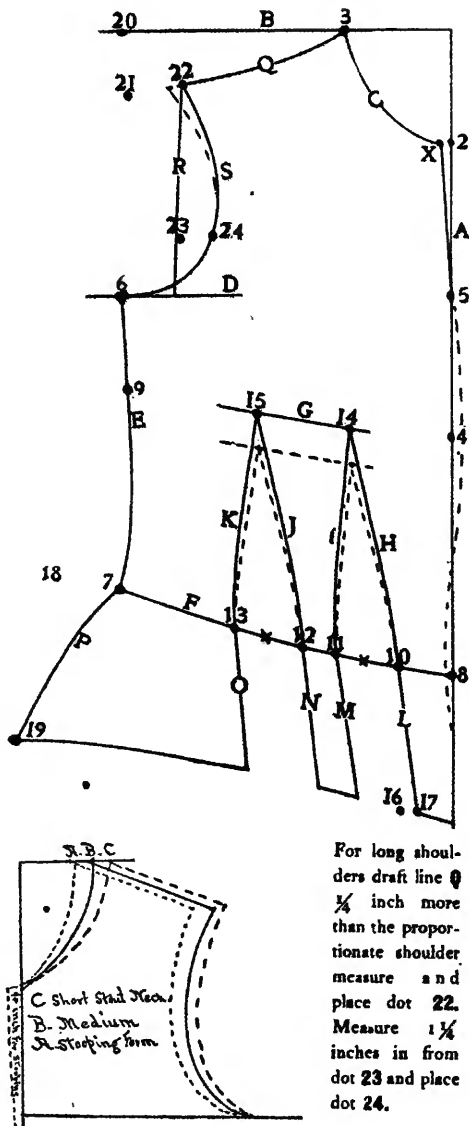

For long shoulders draft line Q $\frac{1}{4}$ inch more than the proportionate shoulder measure and place dot 22. Measure $1\frac{1}{4}$ inches in from dot 23 and place dot 24.

To locate Dot 10 from D x 3.

WAIST MEASURE.		
18 to 20.....	1	inch
21 to 23.....	$1\frac{1}{4}$	"
24 to 27.....	$1\frac{1}{2}$	"
27 & 28.....	$1\frac{3}{4}$	"
29 & 30.....	2	"
31 & 32.....	$2\frac{1}{4}$	"
Above 32 inches the same proportion.		

To place Dot 12 from Dot 11.

WAIST MEASURE		MEASURE.
19, 20 and 21— $\frac{1}{4}$ inch		Bust.....34
22, 23 and 24— $\frac{1}{2}$ "		Waist.....22
25, 26 and 27— $\frac{1}{2}$ "		Front.....15
28, 29 and 30— $1\frac{1}{4}$ "		Back.....15
		Under Arm.....8
		Neck.....11
		Arm's Eye.....16
Above 30 inches in same proportion.		

FRONT.

- 1 Draft line A $1\frac{1}{4}$ inches from the edge of goods.
- 2 Draft line B one inch from the end of goods.
- 3 Measure the distance given in the neck table (according to size of neck) under dot 2 on line A from line B and place dot 2.

NECK TABLE.

Dot 2	2	$2\frac{1}{4}$	$2\frac{1}{2}$	$2\frac{3}{4}$	3	$3\frac{1}{4}$	$3\frac{1}{2}$	$3\frac{3}{4}$	4	$4\frac{1}{4}$	$4\frac{1}{2}$	$4\frac{3}{4}$
Neck	7	8	9	10	11	12	13	14	15	16	17	18
Dot 3	2	$2\frac{1}{8}$	$2\frac{1}{4}$	$2\frac{3}{8}$	$2\frac{1}{2}$	$2\frac{5}{8}$	$2\frac{3}{4}$	$2\frac{7}{8}$	3	$3\frac{1}{8}$	$3\frac{1}{4}$	$3\frac{3}{8}$

- 4 Measure the distance given in the neck table under dot 3 on line B from line A and place dot 3.
- 5 Measure $\frac{3}{8}$ inch straight out from dot 2 and place dot X.
- 6 Place letter C on dot X and draft line C to dot 3.
- 7 Measure $\frac{3}{4}$ of the arm's eye measure down line A from line B and place dot 4.
- 8 Measure $\frac{1}{2}$ of the arm's eye measure down line A from line B and place dot 5.
- 9 Draft f om dot X to dot 5.
- 10 Place the corner of square on dot 5 and draft line D straight out beginning 6 inches from dot 5.
- 11 Measure out line D from dot 5 the distance given in the table for Bust number and place dot 6.
- 12 Measure the length of under arm measure straight down from dot 6 and place dot 7.
- 13 Place letter A on dot 7 and draft line E to dot 6.
- 14 Measure the length of front measure down line A from dot 2 and place dot 8.
- 15 Place letter M on dot 8 and draft line F to dot 7.
- 16 Measure 2 inches down line E from dot 6 and place dot 9.
- 17 Place the corner of square on dot 4, the edge on dot 9 and draft line G out 4 inches beginning 2 inches from dot 4.
- 18 Measure $1\frac{1}{4}$ inches on line F from dot 8 and place dot 10.
- 19 Measure $\frac{1}{2}$ the width of the darts as given in the table, from dot 10 and place dot 11.
- 20 Measure $\frac{3}{4}$ inch from dot 11 and place dot 12.
- 21 Measure $\frac{1}{8}$ the width of the darts from dot 12 and place dot 13.
- 22 Measure the distance between dot 8 and the center of the first dart, and add $\frac{1}{2}$ inch, then measure that distance on line G from dot 4 and place dot 14.
- 23 Measure the distance between dot 8 and the center of the second dart and add $\frac{1}{4}$ inch, then measure that distance on line G from dot 4 and place dot 15.
- 24 Place the $\frac{1}{2}$ mark on dot 10 and draft line H to dot 14.
- 25 Turn the curve over and draft line I, using the $\frac{1}{2}$ mark.
- 26 Draft lines J and K in like manner.
- 27 Measure 5 inches straight down from dot 10 and place dot 16.
- 28 Measure $\frac{1}{2}$ inch in from dot 16 and place dot 17.
- 29 Draft line L from dot 10 to dot 17.
- 30 Draft lines M, N and O parallel with line L.
- 31 Measure $2\frac{1}{2}$ inches straight out from dot 7 and place dot 18.
- 32 Measure 5 inches straight down from dot 18 and place dot 19.
- 33 Place letter A on dot 7 and draft line P to dot 19.
- 34 Measure $6\frac{1}{2}$ inches from dot 3 on line B and place dot 20.
- 35 Measure $1\frac{1}{4}$ inches straight down from dot 20 and place dot 21.
- 36 Place letter A on dot 3, the edge of curve on dot 21 and draft line Q $\frac{1}{4}$ inch less than the proportionate length of shoulder and place dot 22 (see table on curves for distance).
- 37 Draft line R straight down from dot 22 to line D.
- 38 Measure $1\frac{1}{2}$ inches up line R from line D and place dot 23.
- 39 Measure $\frac{3}{4}$ inch straight in from dot 23 and place dot 24.
- 40 Place letter D on dot 24 and draft line S to dot 6.
- 41 Place letter K on dot 24 and extend line S to dot 22.

The front can be curved if desired.
 Place letter E on dot X and draft a curved line T to meet line A $1\frac{1}{2}$ inches below dot 4.
 Place letter H on the end of line T and draft to meet line A 3 inches below dot 8. See dotted lines.
 For a low-cut corset draft a new line G $1\frac{1}{2}$ inches below line G. See dotted lines.
IMPORTANT—The front shoulder is drafted $\frac{1}{4}$ inch shorter than the back and must be stretched to meet the back.

FIGURE 27c. Instructions for drafting front pattern piece.

And by changing the drafting process as fashions changed, Taylor was able to keep his system up to date.¹⁷ His technique did not become obsolete as did so many other hybrid methods.

Nevertheless, Taylor's system for cutting dresses could not have survived for so long without the support of his diversified enterprises. He described his latest drafting techniques in his monthly magazines.¹⁸ In 1857 each number of *Le*

Bon Ton included a fashion report from Paris, four steel engraved fashion plates executed and colored in Paris, and two full-size imported patterns. Also included was a liberal dose of Taylor's advice, observations, and vitriolic criticisms of his competitors. His other publication at the time was *Le Petit Messenger* with a similar format. During the same period he also had a dressmaking establishment at 407 Broadway, New York. Although he warned against their "injurious effect," Taylor also sold patterns, trimmed as they were to be made, in a set with a plain duplicate. He later explained that he must sell them "as long as you are determined to have them, for it would be mortifying to see my subscribers compelled to get patterns from others who never import, but change and fix up their

¹⁷ In 1868, Powell & Kohler reported that they intended to keep their clients up to date with yearly supplements. They may have been copying Taylor's example.

¹⁸ Taylor published as many as five magazines at one time; apparently he never had fewer than two.

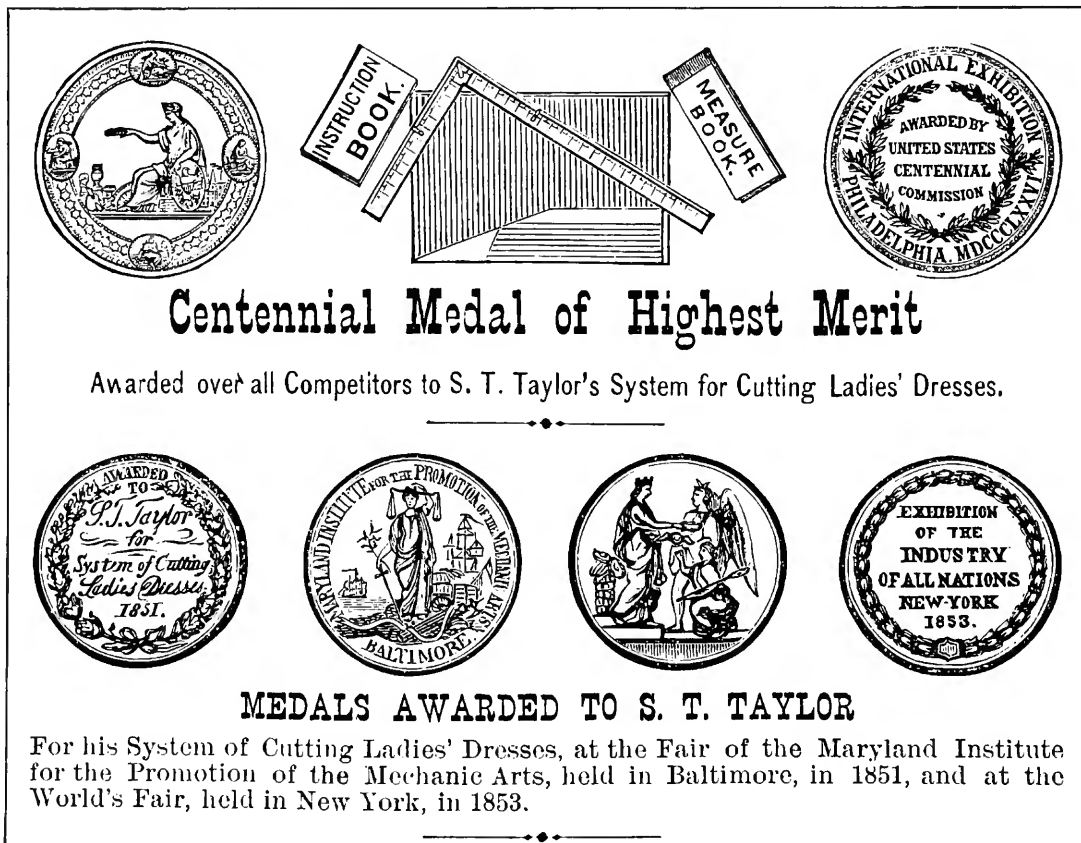

FIGURE 28. Flamboyant promotion for S. T. Taylor's system that appeared in his 1877 instruction booklet. The system had been given a medal at the 1876 International Exhibition in Philadelphia for individual merit, but not, however, a prize "over all competitors" as stated in this notice. As pictured here, a complete S. T. Taylor system consisted of an instruction book, a square, a set of scales, and a measure book, each item (according to his 1875 instruction booklet) priced separately: \$3.00, \$3.00, \$2.50, and \$1.50, respectively. (Library of Congress.)

styles from my importations" (*Le Bon Ton*, 1860:182).

Samuel T. Taylor was a flamboyant entrepreneur and promoter, whose efforts to proselytize sometimes strained the truth. This trait continued to be reflected by his successors after he ceased being active in the company in the 1870s. An example of the double talk that was sometimes used to sell Taylor's system appeared in an 1896 instruction booklet. By this time proportional and hybrid systems had fallen into disrepute among many professional dressmakers who preferred direct-measure methods. It was reported:

S. T. Taylor's System of Dresscutting . . . does not require any special and complicated tool for making its shapes and patterns; a square and tape measure are sufficient. It . . . is a system of actual measurement . . . to however facilitate matters for the dressmaker, and save her a great deal of figuring, a set of scales have been added, two of which are attached to the square in order to make drafting easy, and relieve the mind of the dressmaker from figuring, which sometimes is not much to her taste (Taylor, 1896:24).

The tailors' system that Samuel T. Taylor had converted into a hybrid method for dress cutting was thus, in 1896, blithely called a direct-measure system.

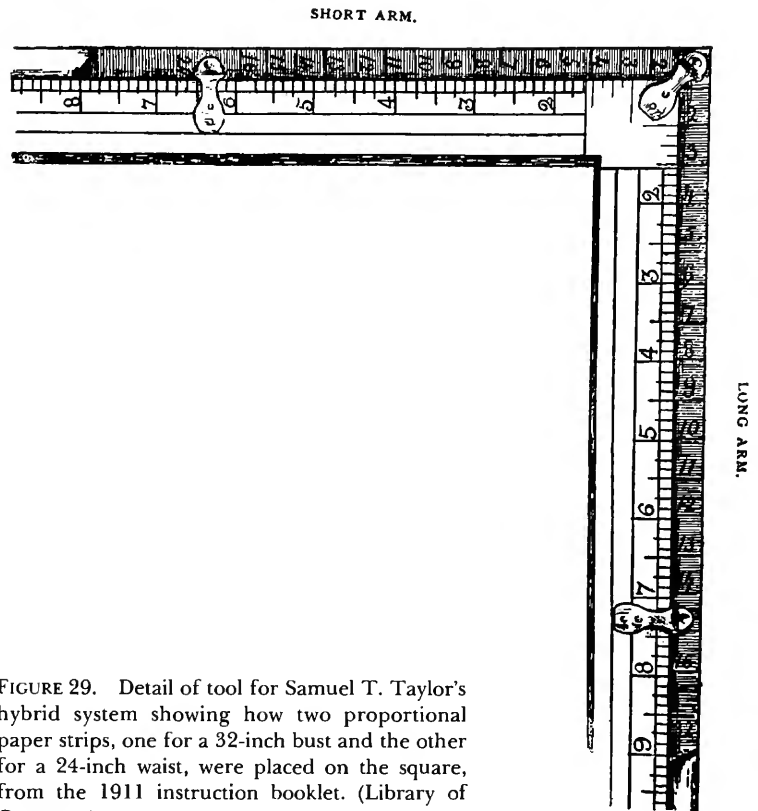

FIGURE 29. Detail of tool for Samuel T. Taylor's hybrid system showing how two proportional paper strips, one for a 32-inch bust and the other for a 24-inch waist, were placed on the square, from the 1911 instruction booklet. (Library of Congress.)

Direct-Measure Systems

Dress fashions in the last quarter of the 19th century (Figures 30, 31) created cutting difficulties that could best be solved by the most accurate techniques. Thus, professional dressmakers preferred direct-measure systems to proportional or hybrid methods. In 1884, Mrs. Elizabeth Gartland, creator of a direct-measure technique, observed:

Dressmaking is not what it was ten years ago, for within the last few years the tendency of the times has called forth the most artistic skill. The close-skin-fitting busts and sleeves of to-day require scientific cutting and fitting. A fault at once shows itself, and disfigures the wearer; consequently, it is more essential to ladies to have perfect-fitting garments now than it has been at any previous time (1884:12).

The whimsy of fashion not only changed the fit of women's dresses, it radically changed the apparent shape of women. To be considered fashionably correct, a woman must have compressed and padded herself to the "right" form by the time she had

finished dressing. In particular, the fashions of the moment dictated a sensuous double reverse curve starting at the back of the neck, becoming concave at the waist, and projecting outward to create that astonishing protuberance called a bustle. Since no woman was formed that way, dressmakers had to create a new shape for their fashion conscious customers. Women's torsos became solid, artificial, multicurvilinear structures over which the outer dress fabric must fit like a second skin. To create this extraordinary style, dressmakers had to cut subtly curved, complex patterns with many pieces (Figure 31). This period, more than any other before or since, required professional dressmakers to be skilled at drafting. Thus they preferred the most accurate type of system, the direct-measure.

In 1896 the Samuel T. Taylor Co. faced this crisis obliquely. Taylor's hybrid system was simply called a direct-measure system. Others, such as



Messe et Pichonier imp. Paris

4037

FIGURE 30. September 1876 fashion plate showing latest Paris costumes with draped skirts and carefully cut bodices shaped to fit smoothly over the hips, from *Journal des Demoiselles*. (Smithsonian Institution.)

Mrs. Louisa L. Jackson of Richmond, Indiana, dealt with the problem more directly. When Mrs. Jackson was granted a patent, 25 May 1869, her method was a hybrid system using six direct measurements. The curved perforated tool was made of sheet metal or cardboard (Figure 32). When she published the 1876 edition of her instruction booklet, Mrs. Jackson's system had become a direct-measure method.

Under the new system nine measurements were required. The curved, perforated tool used inch scales for linear dimensions such as length of center front or width of shoulders and apportioning scales for circumferential measurements such as waist or "arm size" [armscye] (Figure 33). The 1876 Jackson system produced a more accurate draft than the earlier method but the drafting process was not easily learned and remembered. It was not that there were any calculations to be made—the apportioning scales eliminated that complication—but the many steps that had to be followed in a specific order meant that it took a lot of practice to use this procedure with any speed. A miniature tool, along with the full-size version, was enclosed in the instruction booklet for the beginner to use for practice.

Probably the most serious problem for the 1876 Jackson system was that the tool looked too much like the old proportional and hybrid "charts" and "models." It was not similar in principle, but the curved perforated tool was superficially similar in form. Apparently Mrs. Jackson was able to demonstrate the real value of her system as she published at least one later edition of her instruction book. But the mood of the current dressmaking trade was against anything that appeared to be based on proportional dressmaking methods.

The search for "new scientific" techniques took innovators in two different directions. Both were efforts to develop the best possible direct-measure system. One approach reverted to using the simplest of tools while the other developed more specialized drafting devices.

Some dressmakers had become so disillusioned with charts and models, finding them useful only in giving the shape of a piece but not in giving the correct dimensions, that they gave up all specialized tools. Instead, they used just the tape measure to take their measurements and to draft their patterns or linings. These most basic of methods differed from the 18th century ways only in that the

19th century techniques were repeatable, systematic procedures instead of intuitive, individualistic processes.

In 1886 the formidable looking Madame E. W. Mallison (Figure 34) published her direct-measure system in Washington, D.C. Thirteen measure-

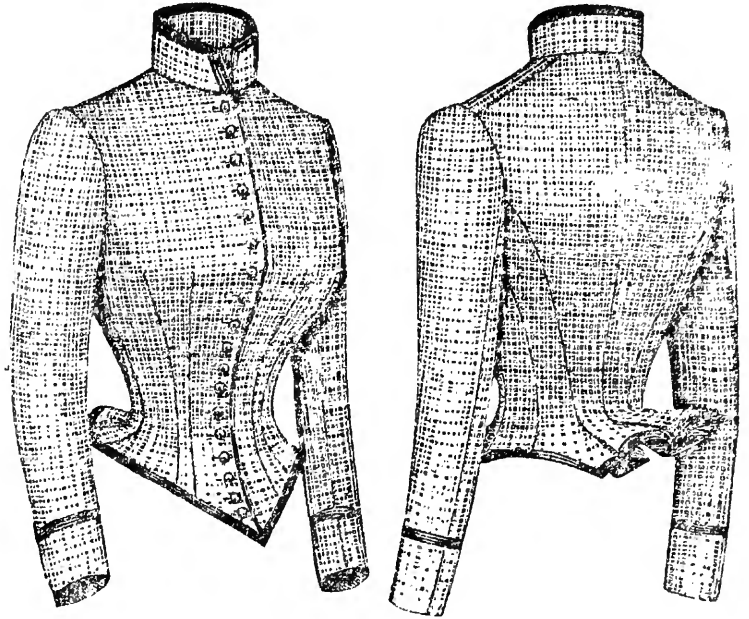
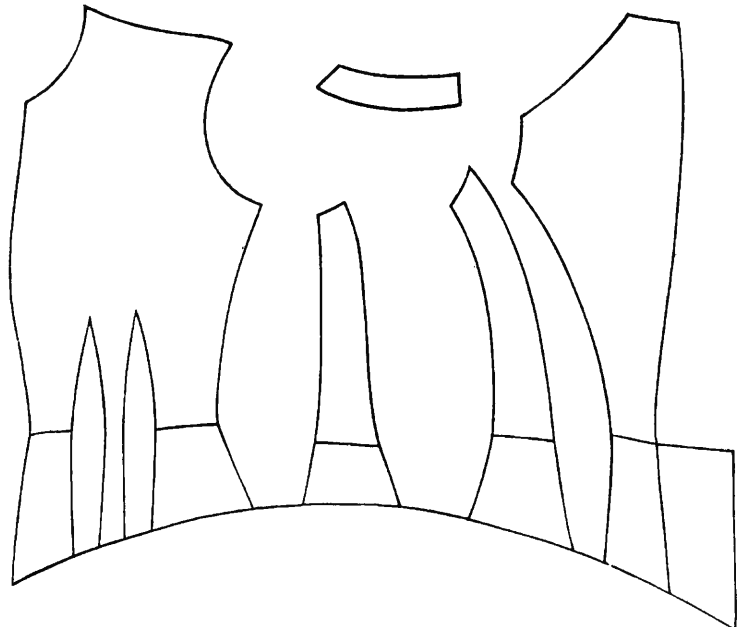

FIGURE 31. The close fitting basque worn in 1886 with a draped skirt distended by a large bustle. The precisely defined shape of the basque (above) required a subtly curved pattern of sophisticated cut (below), from Mme. Mallison, *The Eclectic Lady-Tailor System of Dress Cutting*. (Library of Congress.)



L. L. Jackson,
Ladies' Dress Guide.

N^o 90363.

Patented May 25, 1869.

Fig. 4.

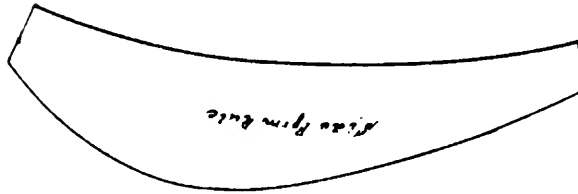

Fig. 3.

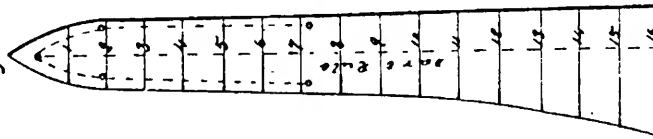

Fig. 2.

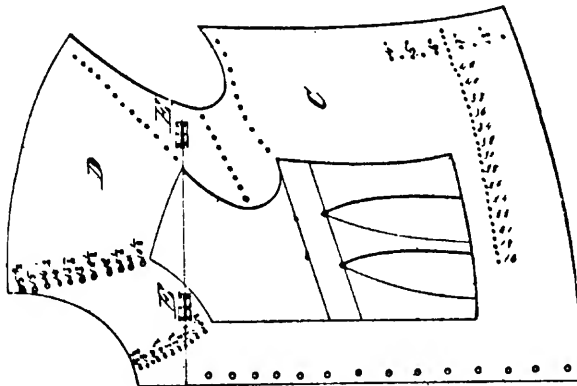
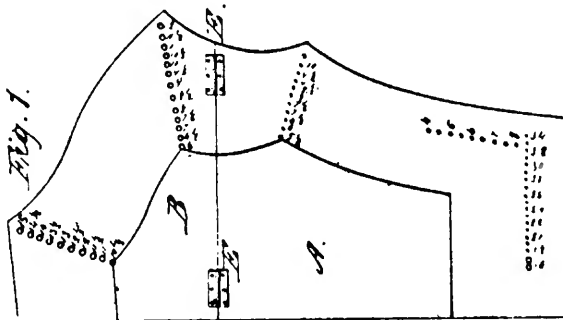

Fig. 1.



Witnesses

*Charles L. Linn
 H. H. Linn*

*Inventor:
 L. L. Jackson*

*By W. H. Linn
 His atty -*

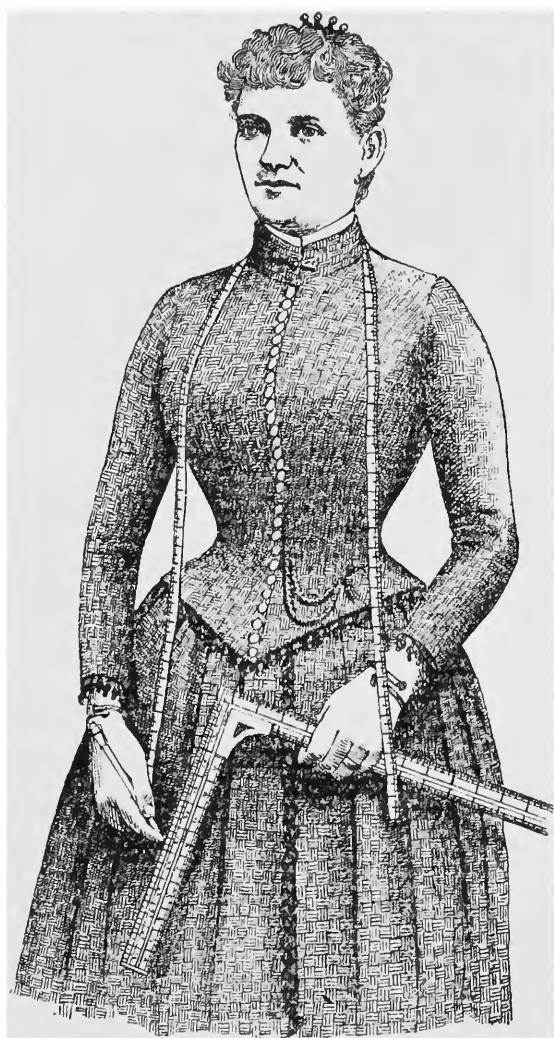

FIGURE 34. Madame E. W. Mallison, as she was pictured in the booklet she published in Washington, D.C., in 1886, presenting her direct-measure system that required no specialized tools. Her drafting method could be followed with only a tape measure and a square. (Library of Congress.)

measuring tape (1886:6). Mallison, however, thought of her technique as a modern scientific system. She called her instruction booklet, *Dress Making Reduced to a Science; the Eclectic Lady-Tailor System of Dress Cutting*.

While direct-measure systems using the simplest of tools may have been accurate, the drafting processes were complicated. A good understanding of

the entire procedure was necessary before an individual could be successful. This requirement was not compatible with the popular demand for an easy-to-use method. A creator of a tailors' hybrid system, Joseph H. Noland, observed in 1861 that "things that are slow to go will soon be no go in the great market of the world—this *busy*, MONEY-making world, where lightning and steam are harnessed up and driven as the wheel-horses of the *new creation*" (Noland, 1861).

By the last quarter of the 19th century, social, economic, and technological pressure made speed, efficiency, and ease of learning a system critical characteristics for a drafting method. Thus, the majority of systems that were described in print during this period required unique tools or devices thought to simplify the application of direct-measure principles of drafting. Each innovator struggled with what he hoped would be the solution to the interrelated problems of efficiency and reliability. The most important types of these direct-measure systems may be divided into three groups according to the common characteristics of the tools—square, adjustable, and conforming.

Squares

The first group used the form of the common tailor's square. To this were added apportioning scales and sometimes curves. James A. Wilson's tool, copyrighted in 1880, added a reverse curve to a square with apportioning scales (Figure 35). Nine measurements including hip circumference were needed to draft a "basque." Another two measurements were needed for the sleeve. Although his tool was printed on paper and attached to a small instruction booklet, Wilson intended that it be applied to wood to make it durable enough to last a lifetime.

Mr. B. T. Phelps of Bellows Falls, Vermont, was granted a patent on 26 June 1883 for a square-type tool he and his wife had been selling for several years (Figure 36). Although the long arm was curved slightly as an aid to drawing curved lines, this device retained the original form of the tailor's square. Eleven measurements (including hip circumference) were used with the apportioning scales to draft a tight fitting "basque." Four more measurements were used to draft the sleeves.

J. R. Bayne's tool, shown in his 1883 instruction

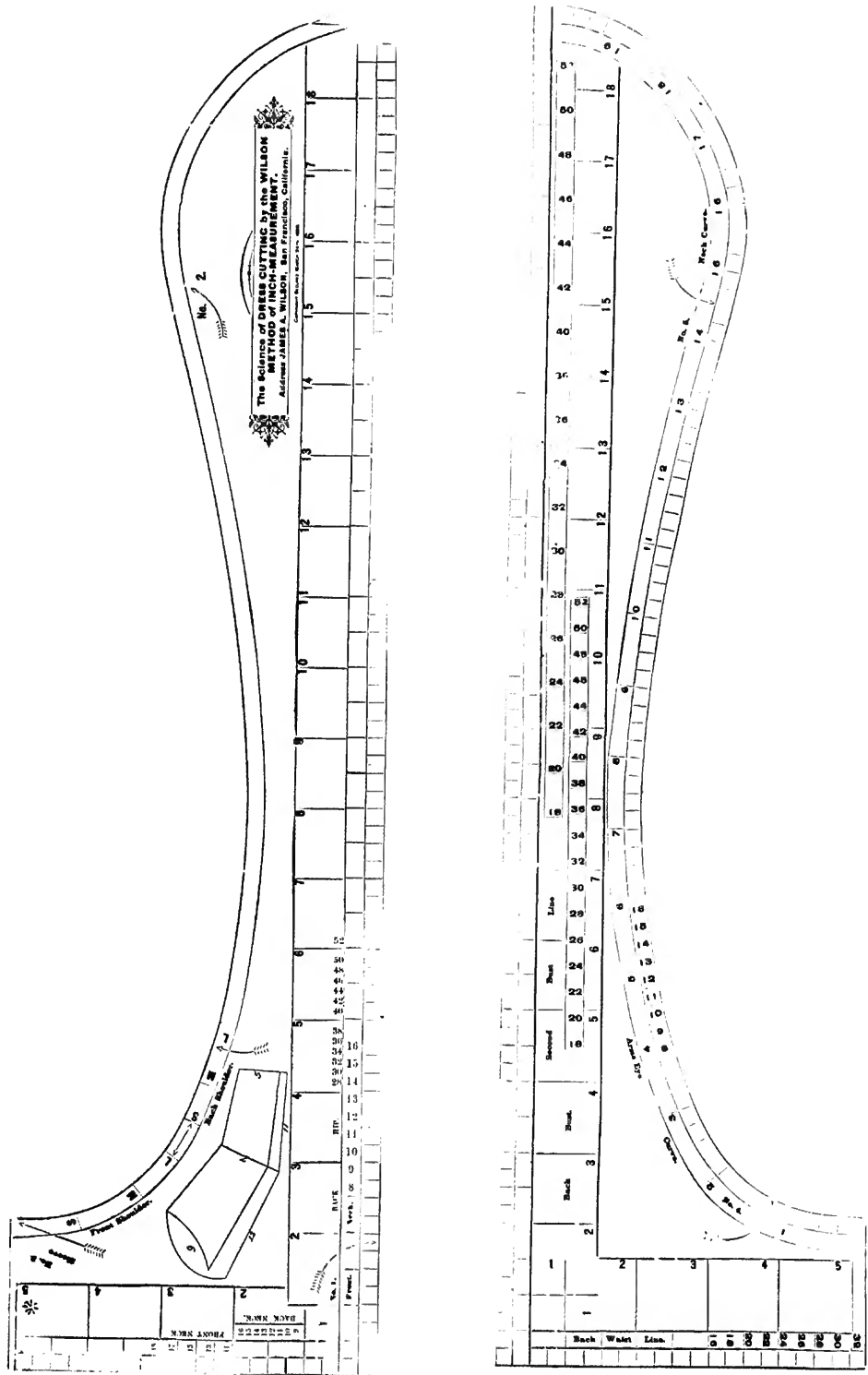

FIGURE 35. James A. Wilson's square tool with curves, which was printed on paper and attached to his 1880 instruction booklet describing a direct-measure system. (Library of Congress.)

(No Model.)

B. T. PHELPS.

DRESS SQUARE.

No. 279,979.

Patented June 26, 1883.

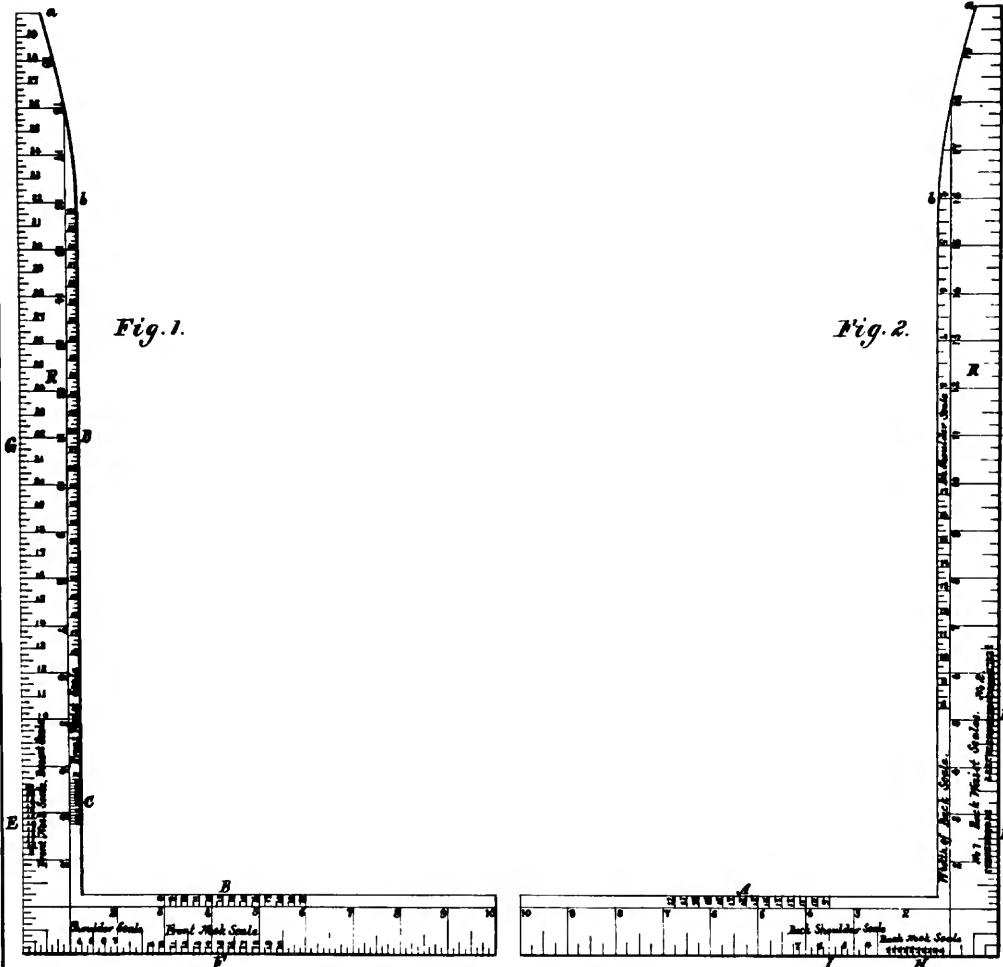

Fig. 1.

Fig. 2.

279,979. DRESS-SQUARE. BRIGHAM T. PHELPS, Bellows Falls, Vt.
Filed Jan 22, 1882. (No model.)

Claim.—The dress-square having a longer and shorter arm, the former having the convex curve *a b* at its end on the inner side for about one-fourth of its length, the said square being provided with the ordinary scale of feet and inches and the various scales for measuring the different parts of the garment, as set forth.

Witnesses.
L. N. Piper
E. A. Pratt

Inventor.
Brigham Thomas Phelps.
by *R. L. May* att'y.

booklet (Figure 37), used more curves than the Wilson device. Ten measurements (including hip circumference) were needed to draft a basque with the apportioning scales. Another six measurements were needed to draft sleeves.

The Wilson, Phelps, and Bayne systems required constant shifting of the respective tools as drafting points and lines were established to define the pattern pieces. The drafting processes required close attention to the step by step instructions. The major advantage of this type of method over those requiring no specialized tools was that the apportioning scales saved the dressmaker from having to make any calculations. But many felt that this was not enough to recommend these systems utilizing squares. In 1891 it was stated that “the time required to learn [systems with squares], the many things to be kept in mind, and their slowness to use after they are understood” convinced many dressmakers “that something more rapid and practical is required for their work” (McDowell Garment Drafting Machine Co., 1891:i).

Adjustable

Adjustable drafting tools were a solution that certain inventors proposed. The best known of this type was the “McDowell Garment Drafting Machine” produced in New York City. Before inventing his adjustable tool, however, Albert McDowell developed a system using a square (Figure 43d) that, minus its sliding arm, was very similar to the Phelps device (Figure 36). The placement and content of the scales were different, but the form was the same. Later the McDowell Company admitted that this system based on a square “was about as slow as the others and required good judgement to use correctly” (1891:i). To emphasize this point further, a McDowell advertising leaflet referred to squares as being useful only as an ornament to hang on the wall (Figure 38).

The preferred McDowell system was a direct-measure method requiring an adjustable tool. In

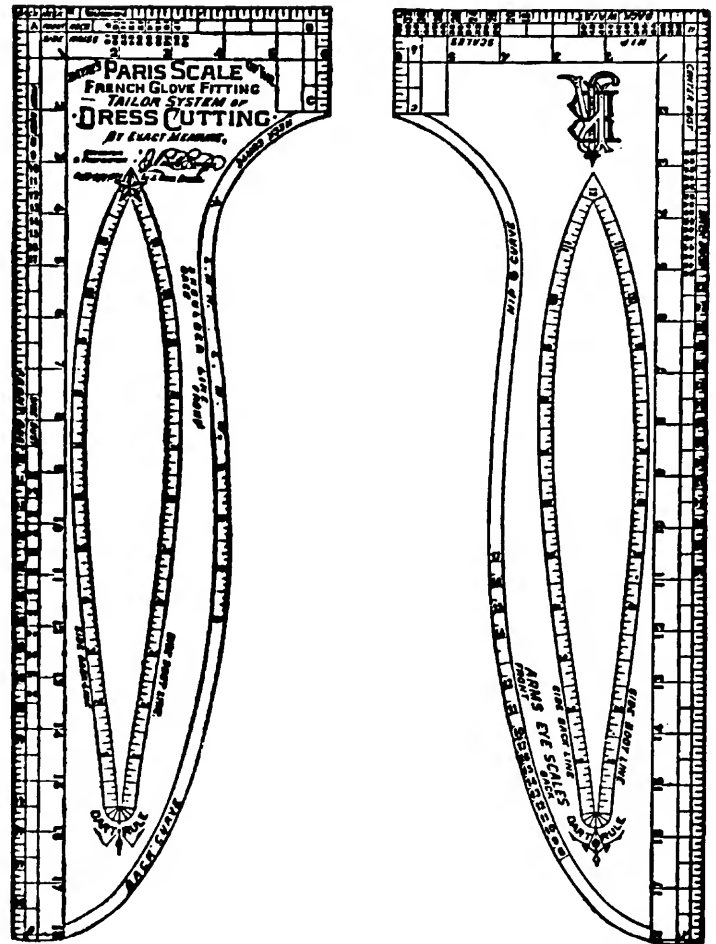

FIGURE 37. Drafting tool illustration included by J. Reid Bayne in the 1883 instruction booklet for his direct-measure system. (Library of Congress.)

this system the prescribed measurements were taken from the customer with an inch tape measure or sometimes with the inch scale on the obsolete McDowell square with sliding arm. The plates of each piece of this metal “machine” were adjusted in a set sequence so that the gauge at each adjustment point was set at the body measurement for that portion of the garment. For example, if the waist measurement was 24 inches, then the waist gauge was eased to the number 24 at each adjustment point. It was not necessary for the dressmaker to figure out how much of the 24 inch waist was to be apportioned to the front, how much to the side, and how much to the back. McDowell’s machine did the apportioning for her. Once all adjustments had been made on one of the ma-

FIGURE 36. The “Excelsior Square” (U.S. Patent 279,979) with apportioning scales, required for Brigham Thomas Phelps’ direct-measure system. According to the 1883 instruction book published in Bellows Falls, Vermont, the complete Phelps system—the tool, the instruction book, and a measure book—cost \$15. (U.S. Patent Office.)

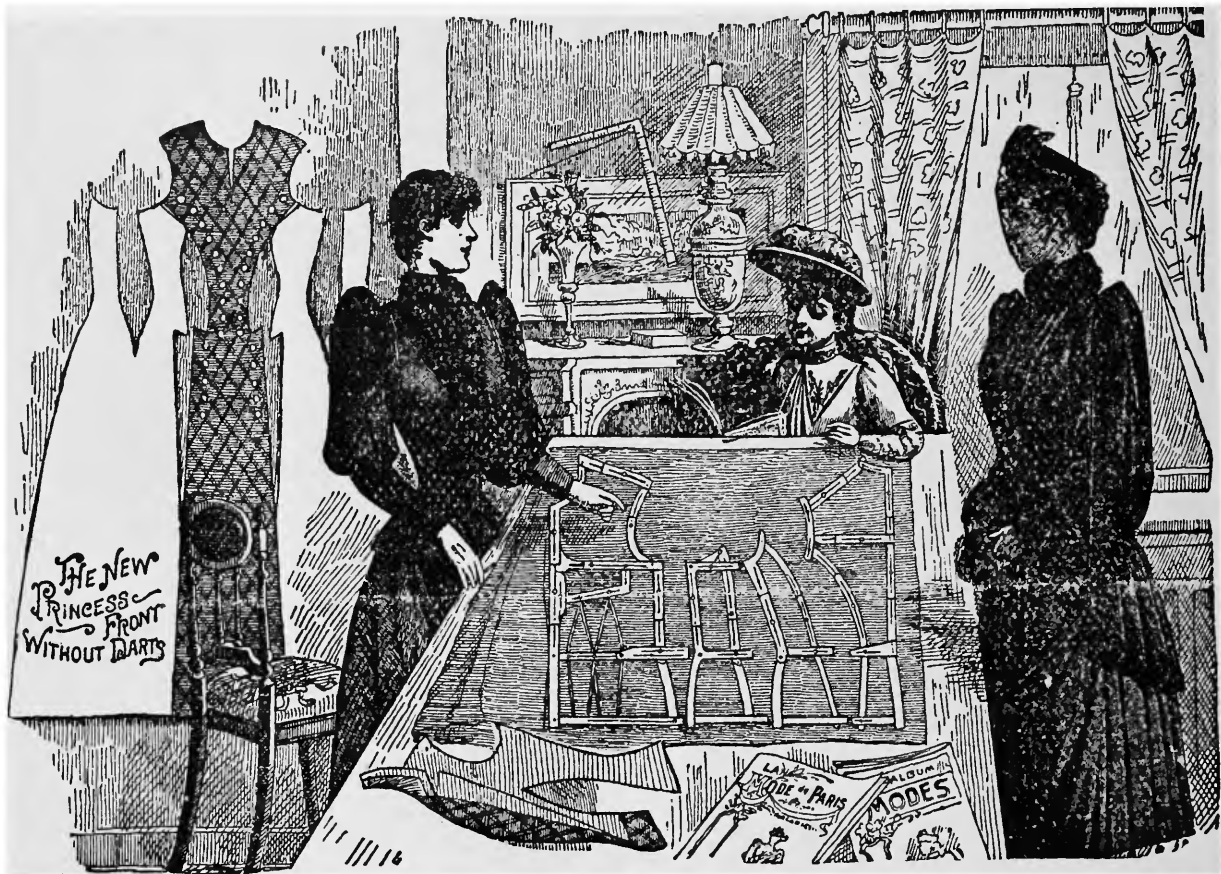

FIGURE 38. According to the dressmaker pictured in this c.1892 McDowell advertisement, her tailor's square hangs on the wall as an ornament since she started using the McDowell Garment Machine. (Smithsonian Institution.)

chine's pieces, a pattern was drawn by following the outline established by the tool.

McDowell proposed or made at least five different forms of his machine. These variations were reflected in the drawings that accompanied McDowell patent specifications and the illustrations included in McDowell instruction booklets. Three U.S. patents were granted to Albert McDowell: 213,436 on 18 March 1879, 310,297 on 6 January 1885, and 342,216 on 18 May 1886. (The innovations covered by the last U.S. patent had been patented earlier in England on 10 August 1885.) I have also examined instruction booklets for the McDowell system with copyright dates ranging from 1883 to 1891. There were subtle differences between McDowell tools such as re-

finements intended "to remove non-essential and extraneous parts which only add to the weight and cumbersome character of the pattern" (U.S. Patent 342,216:1). There were also minor developments such as an extension for prescribing the facing with a longitudinal slot indicating the location of the line of buttons and buttonholes. This was introduced in the 1885 patent (Figure 41a) but was not shown in the 1886 patent (Figure 42a).

The most significant differences between the various forms of the machine, however, were caused by fashion changes. The 1879 patent specifications submitted on 18 May 1878 showed a device for drafting a bodice requiring three different pattern pieces (Figure 39). The front piece of the machine was used to draft two darts for fitting

the bodice over the bust to the waist. This piece also provided for a third, but optional dart which permitted closer fitting of the bodice under the arm to the waist. Dress styles of the 1860s and early 70s had no need for this dart. By the mid-70s however, tighter corseting and closer fitting, longer waisted dress styles required an underarm dart for better fit. Additional fashion changes, however, necessitated the modifications in the machine that were covered by the 1885 patent (applied for on 11 December 1883). The front piece of this version made the underarm dart, which McDowell called a hip dart, much more important (Figure 41a). The back piece provided for the fashionable curvature of the back by incorporating an offset drafting point on the inner edge of the center back plate (Figure 41b). And both the back and side pieces were designed for drafting a closely fitting extension about four inches or more over the hips. With these modifications a basque could be drafted with a closely fitted waist.

Despite his efforts, fashions changed before McDowell could complete any new version of his machine and protect it with a patent. The dress that could have been drafted by the tool covered by his first patent, 1879, had already become old fashioned by that date. Thus McDowell did not wait for patent protection before marketing his next modification. The machine shown in the instruction booklet with a copyright date of 1883 (Figure 40) had the "hip dart," which was not covered by a patent until 6 January 1885 (Figure 41). By that date his machine was again obsolete. On 30 July 1885, Albert McDowell applied for his third and last American patent which was granted on 18 May 1886. The McDowell machine for drafting basques had expanded to four pieces (Figure 42a,b). As McDowell put it, "By separating the front-body pattern from the pattern for the underarm piece I am better enabled to follow the usual division of the waist as now made . . ." (U.S. Patent 342,216:4). It seems apparent that Albert McDowell was tired of pushing to keep the patented form of his machine up to date with the latest fashions. In this, the last of his patents, he stated, "I do not wish to limit myself to the precise construction of the pattern herein described, as this may be varied to some extent without departing from my invention . . ." (U.S. Patent 342,216:4).

Modish dress styles continued to change but, fortunately for the McDowell enterprises, dame fashion concentrated on the sleeves and skirt for most of her alterations until the century ended. Thus, the two McDowell machines in the Smithsonian Institution's collections, which were purchased by their original owners Lillian Duncan (Figure 43a) about 1891 and Emma Eckhart about 1892, are basically the same type of machine as that shown in the 1886 patent. Eleven measurements (including hip circumference) were needed to draft a basque. Five more measurements were needed for sleeves. This two-piece appendage could be drafted by another McDowell machine (Figure 43b) which was also included in McDowell's last patent (Figure 42c). The "McDowell Sleeve Machine" was not, however, absolutely essential. The instruction booklet for the garment machine included a section describing how to use the McDowell square to draft sleeves.

In 1883 Albert McDowell stated that his machine was far superior to any of the other systems he had been experimenting with since about 1871. "It requires no guess-work, and almost entirely discards figuring . . ." (McDowell Garment Drafting Machine Co., 1883:3). It is refreshing to find that, for once, the boasts of a drafting system promoter were well founded. The "McDowell Garment Drafting Machine" was easy to understand and simple to use. Its value was acknowledged in its own time. And today more examples of the McDowell tool are extant than of any other dressmakers' drafting device.

The "Buddington Dress Cutting Machine" (Figure 44) was a contemporary competitor of the McDowell machine. Mr. and Mrs. F. E. Buddington probably produced their first system in 1880 (Buddington, 1887:1). The first of four patents was granted to F. E. Buddington on 13 February 1883 (U.S. Patent 272,204) and the last was granted on 31 January 1899 (U.S. Patent 618,319). Both the McDowell and the Buddington methods were direct-measure systems requiring adjustable tools. The Buddington procedure, however, was not as easy to follow as the McDowell process. To draft the front and underarm pattern pieces of a four-pattern-piece bodice four adjustments were initially made to the front piece of the Buddington tool in 1887. The dressmaker then carefully followed 36 steps, which included moving the tool 12

FIGURE 39a,b. Diagrams of Albert McDowell's first patented adjustable metal tool (U.S. Patent 213,436) for his direct-measure system. (U.S. Patent Office.)

FIGURE 39a. Front.

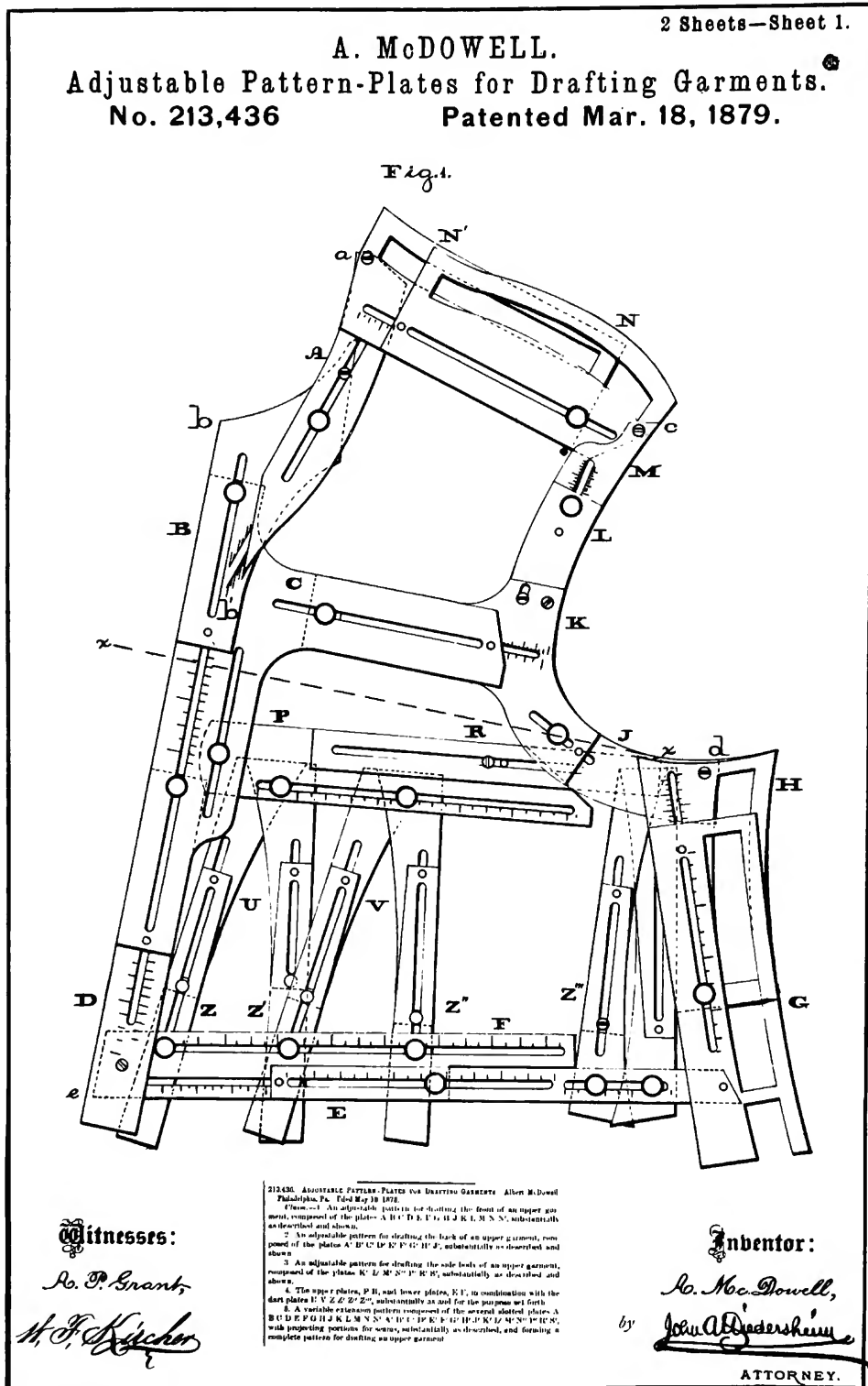
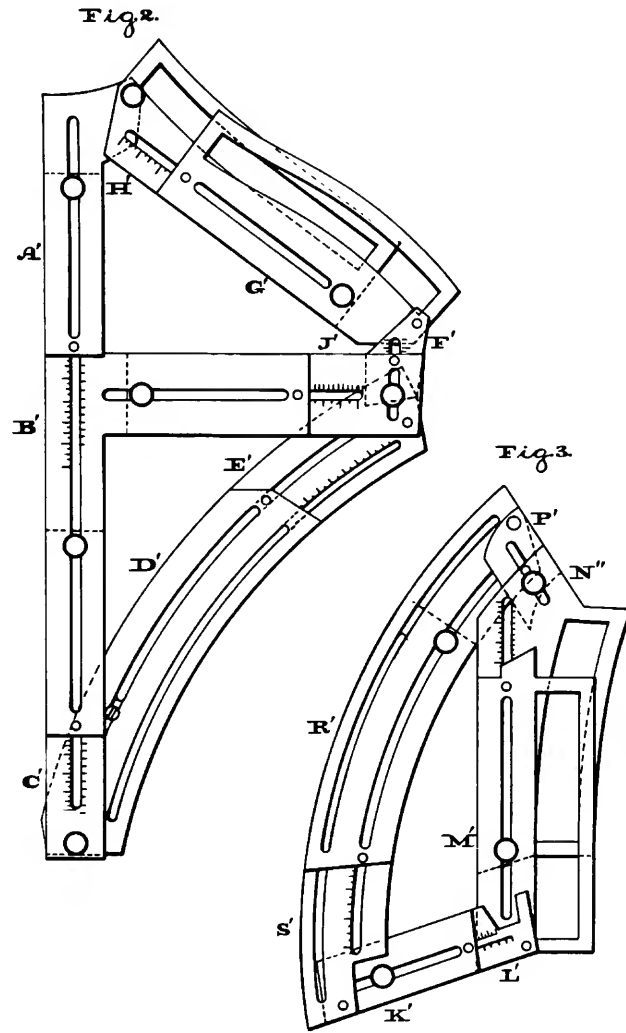

FIGURE 396. Back, side-back.

2 Sheets—Sheet 2.

A. McDOWELL.
 Adjustable Pattern-Plates for Drafting Garments.
 No. 213,436 Patented Mar. 18, 1879.



Witnesses:

No. P. Grant,

W. F. Fischer

Inventor:

No. McDowell,

John A. Anderson

ATTORNEY.

FIGURE 40. The three-piece adjustable tool shown on this 1883 McDowell instruction booklet cover closely resembles the tool covered by the second McDowell patent issued about two years later. The complete system—including a brass tool, instruction book, measure book, square, diagram for setting machine, diagram for measuring, tracing wheel, tape line, and box—cost \$17.50. The complete system with a tool made of nickel instead of brass cost \$20.00 (Library of Congress.)

INSTRUCTION BOOK

—FOR—

DRAFTING AND CUTTING

DRESSES, BASQUES, SACKS, COATS, ETC.

—BY THE—

GARMENT DRAFTING MACHINE

AS INVENTED AND PATENTED

—BY—

A. McDOWELL.

THE McDOWELL GARMENT DRAFTING MACHINE CO.,

No. 6 W. 14TH STREET, NEW YORK, U. S. A.

The Garment Drafting Machine being secured by Letters Patent, all parties found infringing on our rights will be dealt with according to law.

AGENCIES WILL BE GIVEN TO RELIABLE PARTIES.

FIGURE 41a,b. Diagrams for the second patented form of Albert McDowell's tool (U.S. Patent 310,297) for direct-measure drafting, patent applied for on 11 December 1883. (U.S. Patent Office.)

FIGURE 41a. Front (statement of claims partially obscured in reproduction).

(No Model.) 3 Sheets—Sheet 1.

A. McDOWELL.

ADJUSTABLE PATTERN FOR DRAFTING DRESSES.

No. 310,297. Patented Jan. 6, 1885.

310,297. ADJUSTABLE PATTERN FOR 1
ALBERT McDOWELL, New York, N. Y. Filed Dec.
Claim.—1. An adjustable pattern for drafting
whole or a portion of the edge formed of plates of
ranged that the inner edge corresponds to the semi-
edge to the cutting-line, so that both lines can be
one operation, all substantially as herein specified.

2. In an adjustable pattern for drafting the fr
front gage composed of two or more separate plates
and provided with longitudinal slots 1, correspondi
long and button-holes, an edge 2, corresponding
and an edge 3, corresponding to the cutting-line, so
so that all three lines may be drafted at a single s
term, all substantially as herein specified.

3. In an adjustable pattern for drafting the i
ment, two or more dart-gages having their lower e
waist-gage at adjustable distances apart, in comb
brace, F', pivoted at adjustable height in the front
other end is free to adjust itself on the brace-gage 1

4. In an adjustable pattern for drafting the fr
the extensible plates G' G', in combination with a
suitable front-line gage and two or more extensible
Z', and pivot-pins Z', Z', Z', and Z' as herein speci

5. In an adjustable pattern for drafting the fr
the horizontal plate E, in combination with the bra
plate, U', provided with suitable guiding and adj
justing-screw 1", connecting the arched-gage G' i
and the hip-dart gage Z' Z', and side-scan g
not for adjusting their positions, all adapted to ser

6. In an adjustable pattern for drafting garm
connections Z' Z' on the bust-gage E, whereby th
Z' Z' Z' are adjustable at variable distances ap
tion with means for also adjusting the distance ap
for shifting the position of the piece relatively to
substantially as and for the purposes herein speci

7. In an adjustable pattern for drafting gar
plates I and J, in combination with the hip-dart g
and with the properly-slotted gages G' and E, as he
specified.

8. In an adjustable pattern for drafting the b
upright plate M', branch or cross piece M', and ca
cated at each end and made in two separate parts,
in combination with the adjusting means P', adapt
specified.

9. In an adjustable pattern for drafting the si
independent of the back and front, the plates U' V'
justable, as shown, in combination with each oth
T' T' W', for drafting the side body, substantially

Fig. 1.

hip dart

dart

WITNESSES—
Charles K. Searle,
No. F. Boyle.

INVENTOR—
Albert McDowell
By his attorney
Thomas S. Peterson

FIGURE 41b. Side-back and back.

(No Model.)

3 Sheets—Sheet 2.

A. McDOWELL.

ADJUSTABLE PATTERN FOR DRAFTING DRESSES.

No. 310,297.

Patented Jan. 6, 1885.

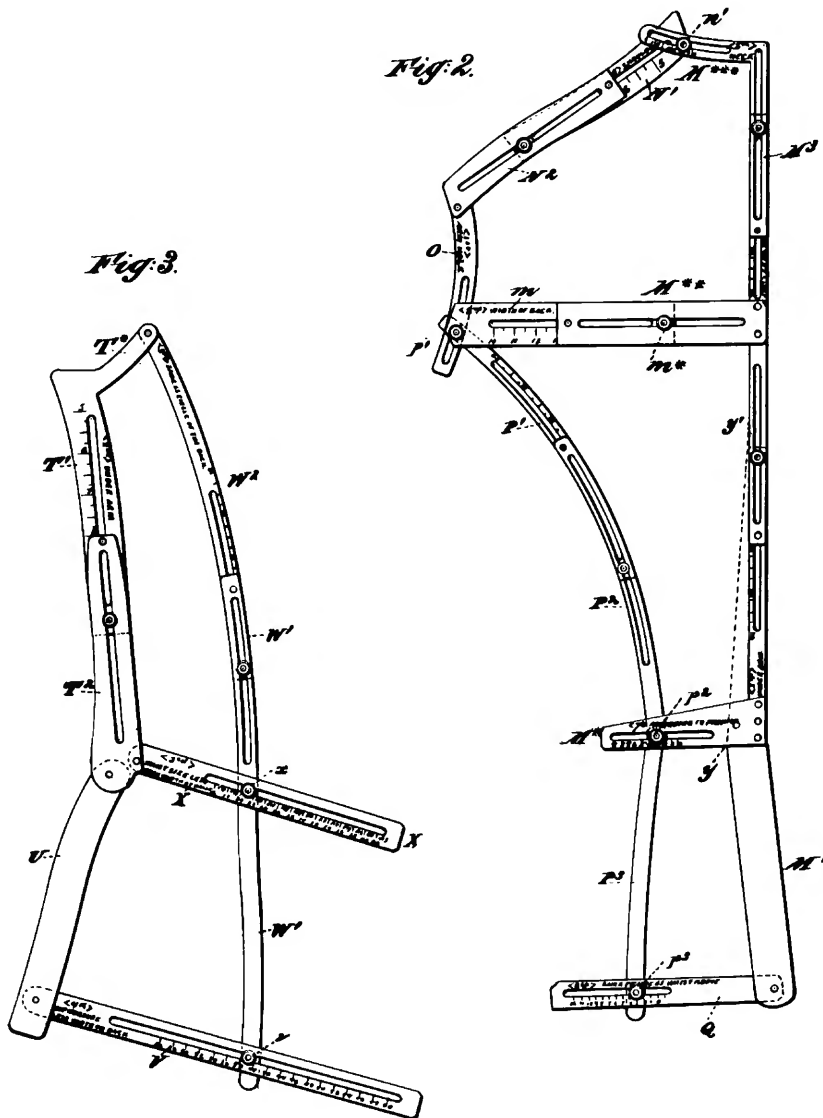

WITNESSES—

Charles R. Seale,
No. J. Boyle.

INVENTOR—

Albert McDowell
By his attorney
Thomas D. Weston

FIGURE 42b. Side-back and back.

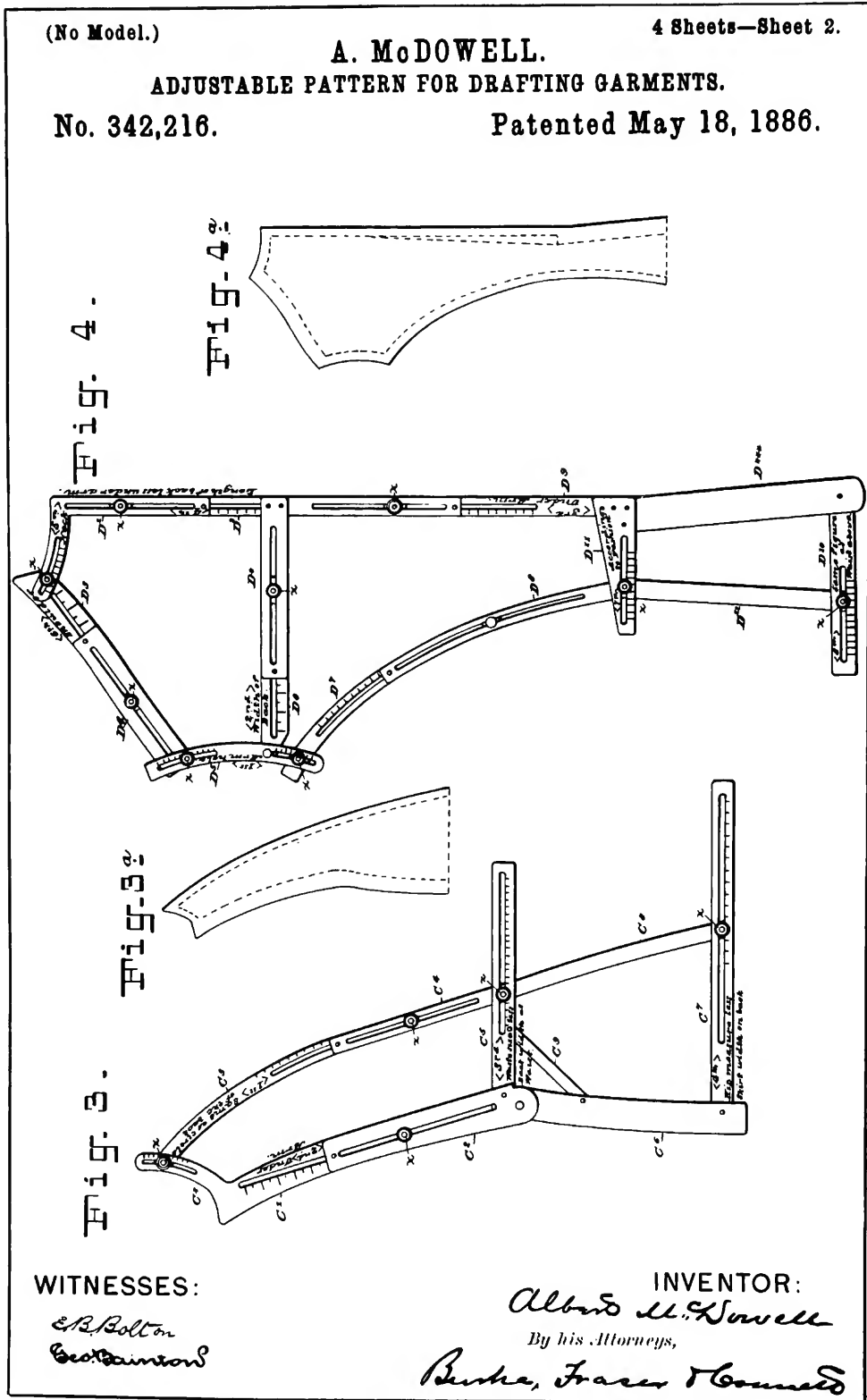
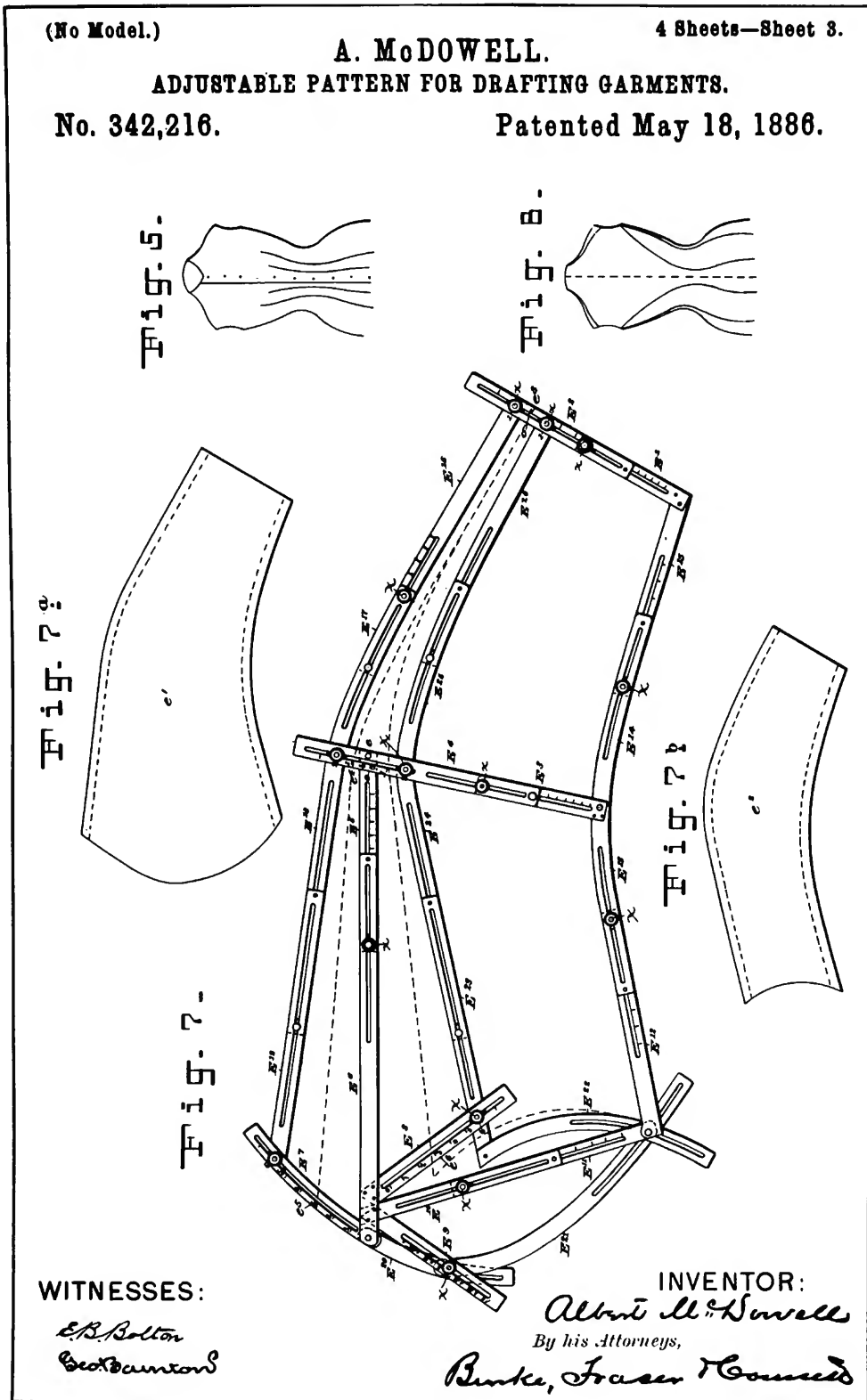
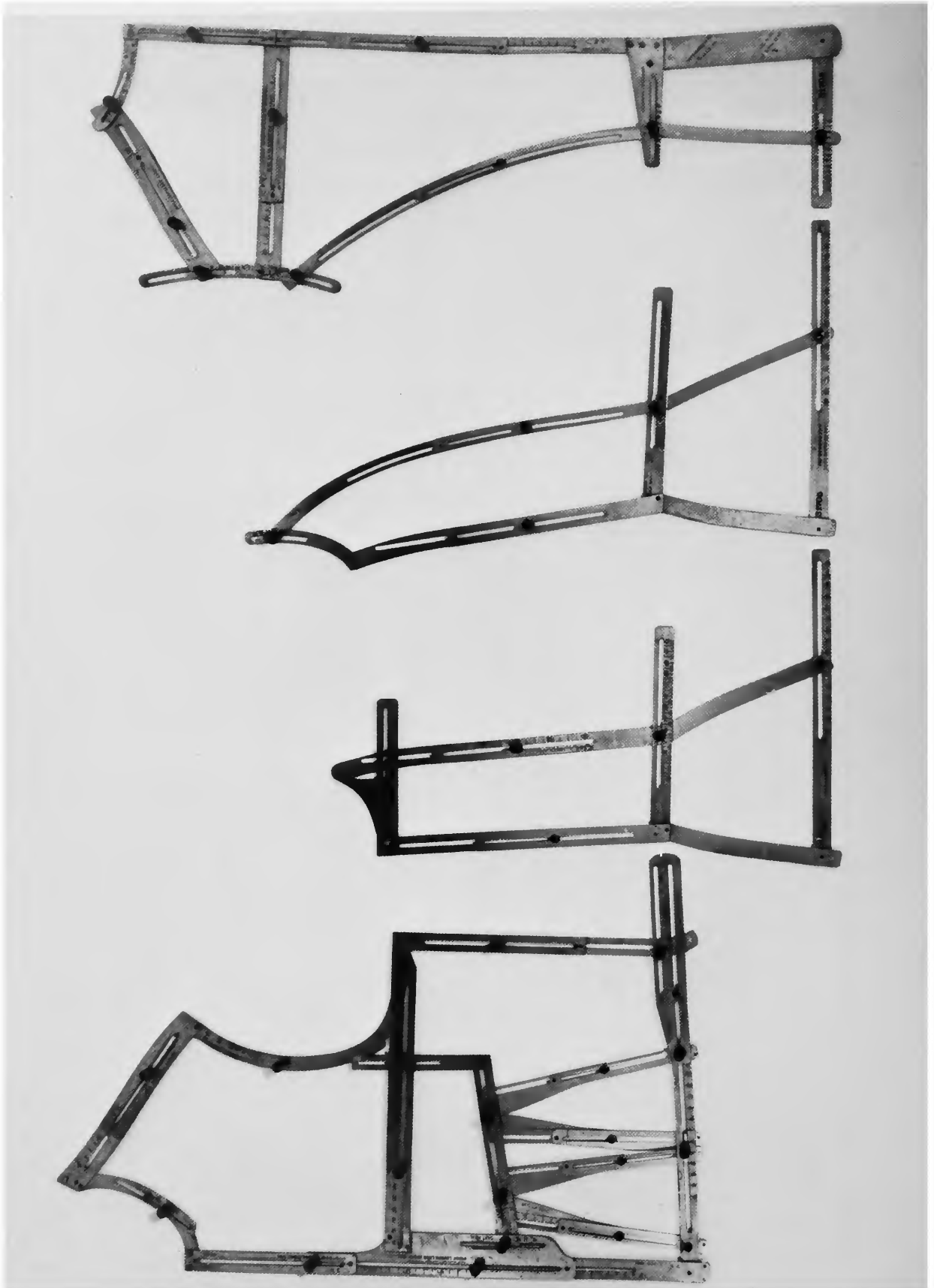

FIGURE 42c. Sleeve.







A. McDOWELL, PRESIDENT

W. McDOWELL, TREASURER



4 & 6 West 14th St.

Cable Address: MCDOWELLA.

NEW YORK

119 East 1891

This is to certify that the
 bearer (Miss Lillian Duncan)
 has taken a complete course
 of instructions in cutting
 Ladies' Garments at our
 "School for Cutting" # 6 West
 14th St New York City and
 with practice should be fully
 competent to do first class
 work as a dressmaker & to
 take a good position as
 cutter

The M. Gougeon Garment Drafting Machine Co.
 A. McDowell Pres

FIGURE 43a-d. Components of McDowell's direct-measure drafting system purchased by Lillian Duncan about 1891. (Smithsonian Institution).

FIGURE 43a (left). "McDowell Garment Drafting Machine."

FIGURE 43b (above, left). "McDowell Sleeve Machine."

FIGURE 43c (above, right). Certificate of Lillian Duncan's successful completion of a course in cutting ladies' garments, signed by Albert McDowell.

times and adjusting the tool four more times in order to make 20 dots and draw 25 lines. In comparison, drafting the front half of a dress by the McDowell system was simple. The dressmaker made 13 clearly marked adjustments to the front piece and four to the underarm piece. Then by simply drawing around the outside and the inside of each piece, the dressmaker produced accurately curved patterns marked with the seam allowance.

In 1896, the Buddingtons claimed that "the colossal number of One Hundred Thousand" of their machines were in use (Buddington, 1896:1).



FIGURE 43d. Accessories for the McDowell machines: cardboard box, tracing wheel, instruction books for the two machines, measure book, leather belt used as a guide for taking measurements, and obsolete "McDowell Garment Drafting Square" with sliding arm or gauge used to take some measurements. The majority of individuals listed in the measure book were Duncans living in Brooklyn, New York.

That is hard to believe. Perhaps they had sold that many between 1880 and 1896, but it is doubtful that they were still being used. To the inexperienced dressmaker the Buddington machine could have appeared to be similar to the McDowell machine, which had extensive publicity and wide popularity. The Buddington tool, moreover, was much less expensive. In 1887 the Buddingtons charged \$4.10 for an accessorized set comparable to what McDowell sold in 1883 for \$17.50. The similarity in appearance and the dramatically lower price of the Buddington tools probably occasioned the brisk sale of the less efficient system. I doubt,

however, that many dressmakers who bought the "Buddington Dress Cutting Machine" continued to use it for very long.

FIGURE 44. The improved version of Mr. and Mrs. F. E. Buddington's direct-measure system as shown in an 1896 instruction booklet. The unique features of the two-piece adjustable metal tool were protected by U.S. Patents granted in 1895 (541,311) and in 1899 (618,392). The adjustable slides were held in place by friction. When adjustments were made, care had to be taken to avoid touching (and thus soiling) the orange paper measure strips set into the slides. The tool and instruction booklet cost \$5. (Courtesy of Sydney Brooks.)

INSTRUCTION BOOK

..FOR USING..

The Buddington Improved

DRESS CUTTING MACHINE

WITH DART ATTACHMENT

For Cutting French Bias Basque, Enlarging Darts, etc.

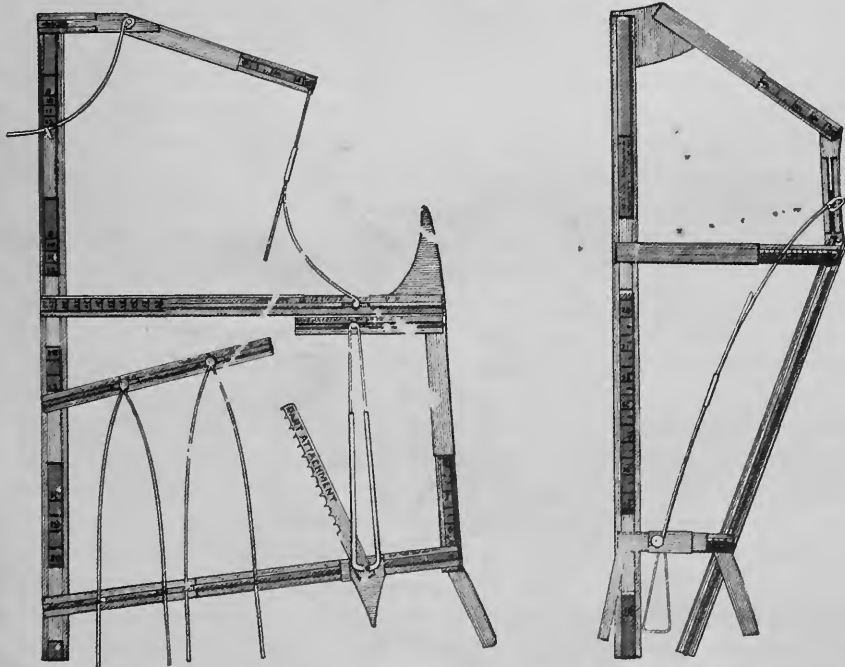

A Perfect Fit Without Change of Seam.

UNRIVALLED IN PERFECT FITTING, EASE OF HANDLING, QUICK ADJUSTMENT,
GREAT SIMPLICITY AND GENERAL CONVENIENCE.

AGENTS WANTED EVERYWHERE.

MR. & MRS. F. E. BUDDINGTON,

2327 INDIANA AVENUE,

CHICAGO.

SECOND EDITION.

Entered According to Act of Congress, February 10, 1890, by F. E. BUDDINGTON, in the Office of the Librarian of Congress at Washington, D. C.

In 1896, the Buddingtons produced their “Improved Dress Cutting Machine” (Figure 44), but insisted:

We do not intend this improved machine shall supplant the other, we shall make and sell the other machine as long as there is a person that wants it. But this is an age of rush and hurry. Dress Makers want a machine they can lay on a bolt of cloth, turn a crank and have the dresses come out finished in assorted sizes; we have not quite accomplished this, but think we have come as near it as it is possible to get (Buddington, 1896:1).

Actually, the Buddingtons did not come very near at all. For example, their “improved” system only reduced the process of drafting the front and the underarm pattern pieces from 36 to 33 steps.

Conforming

The previously described direct-measure systems differed from each other in the form of the tool, the procedure for laying out the pattern, and, to some extent, the kind of measurements that were required. They had, however, one characteristic in common—the dressmaker had to take the specified measurements very carefully. Thus each instruction book described in detail how the measuring tape should be placed and how tightly it should be drawn. Frequently, explicit drawings were included to reinforce the written directions. The creators of these systems agreed that the success of their methods depended largely upon the accuracy with which the measurements were taken. There was another category of direct-measure systems, however, that did not require the dressmaker to use a tape measure. These systems used conforming tools or “conformators,” made to be placed on a person and adjusted to conform to her shape.

Angeline P. Wickersham’s “Pattern Marker,” patented in 1881, had the appearance of a medieval torture machine (Figure 45).¹⁹ It was made of thin flexible strips of metal such as brass, tin, or copper which corresponded to the seams of the dress bodice. Each strip was studded by a series of pointed prongs, and the whole contraption was strapped to one half the body by means of elastic bands. Paper or a lining fabric was pressed upon the prongs, effectively marking the outline of each

pattern piece. Undoubtedly Miss Wickersham was correct when she stated that “in no case, so far as I am aware, has a pattern-marker been designed to fit the body and prick the pattern out upon the paper without any measurements being taken or laid out upon the paper” (U.S. Patent 242,240:1).

William B. Pollock was granted a patent in 1885 for another type of direct-measure system requiring a conforming tool (Figure 46). The Pollock device completely encircled the torso and could be adjusted to conform closely to the body. Ingenious spring clips held the adjustments so that the device could be removed from an individual and separated. It was then laid flat on paper and used as a guide for drafting a pattern. Pollock proudly stated that he had developed a device for cutting a garment that fit “without requiring any skill or calculation on the part of the operator or fitter” (U.S. Patent 320,496:1). He was so confident as to the value of his achievement that he also obtained a British patent, number 7652, in 1885.

Both Wickersham and Pollock devised tools that eliminated the need to measure a customer. The chance of human error was greatly reduced. No indication has been found, however, that either tool was produced. The cost of making them probably made the selling price too expensive for the average dressmaker. Other conforming tools were produced, although they were not as efficient as the Wickersham and Pollock inventions.

In 1904, Jean B. Peyry offered his “Conformateur and Systeme Metrique” to dressmakers on two continents. (Dressmakers in the “Southern or Western States or Central America” were directed to contact the “Professor” in New Orleans; those residing in “Canada or New England States” could reach him in Montreal; and inhabitants of “France or Europe” were to address him in Paris.) As a citizen of France residing in New Orleans, Peyry was granted a U.S. patent (626,795) on 13 June 1899. He claimed also to have received a patent the same year in Europe (1904:1). In his specifications submitted to the U.S. Patent Office, Peyry described his “garment fitting device” as a series of frames consisting of independently adjustable plates, doubly pivoted at each end to other plates. Although he said these plates could be made of leather, tough cardboard, or celluloid, he recommended sheet metal—steel, brass, or preferably aluminum.

¹⁹ The signature (executed by her attorney) on the patent application shows her first name as Angelina, but all printed versions of it in the patent documents are spelled “Angeline.”

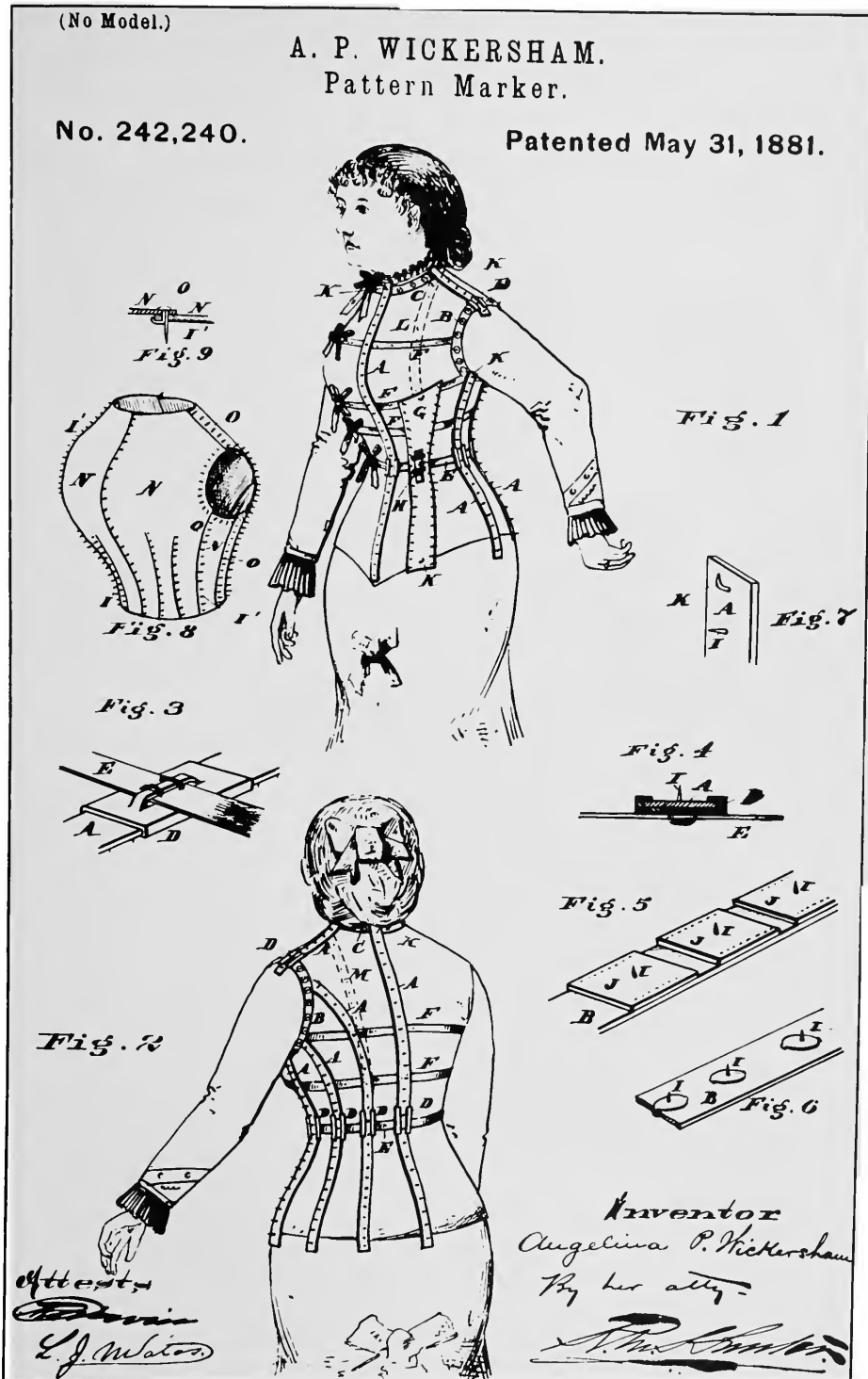

FIGURE 45. Angeline P. Wickersham of Philadelphia received a patent (242,240) in 1881 for this "Pattern Marker" constructed of flexible bands with projecting pins. This conforming tool represents those many inventive aberrations that were never commercially successful. (U.S. Patent Office.)

(No Model.)

W. B. POLLOCK.

GARMENT MEASURING AND FITTING DEVICE.

No. 320,496.

Patented June 23, 1885.

Fig. 1.

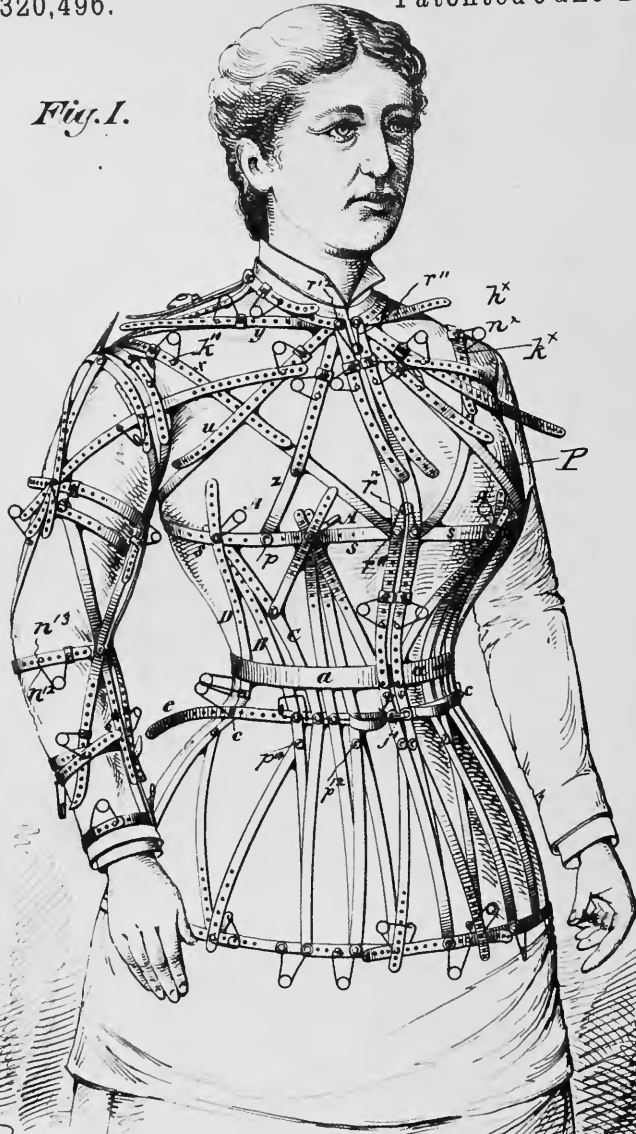

Garment Measuring and Fitting Device. (No Model.)

WITNESSES:
Gustave Dietrich
And Huntwick

INVENTOR.
William Bloomer Pollock.

320,496. GARMENT MEASURING AND FITTING DEVICE.
 W. B. POLLOCK, Philadelphia, Pa. Filed Jan. 15, 1884.
 Claim—1. A measuring and fitting device comprising a series of separable frames or sections, each composed of separately and independently adjustable flexible straps pivoted one to the other in triangular form throughout the sections, and means for securing the straps in their adjusted position, whereby said sections may be adjusted to fit the figure of the individual under measurement, and then laid flat upon the goods to be cut, substantially as set forth.
 2. A measuring and fitting device comprising a number of frames or sections separable from each other, and composed of separately and independently adjustable straps, all pivoted one with the other, and having counterweights and stands and fastening devices therefor, as and for the purpose set forth.

Letter - May 15, 1884.
 R. J. Kutter June 5, 1884
 R. J. D. Aug. 27, 1885
 Apr. 4, 1885
 Apr. 18, 1885

Examined Apr. 25, 1885.



FIGURE 47. "Conformateur and System Metrique," offered to Americans by Jean B. Peyry, a Frenchman, in 1904. The drafting tool, as illustrated in his 1904 instruction book, did not have to be used as a conforming device but could have been adjusted flat, as was the McDowell machine. (Warshaw Collection, Smithsonian Institution.)

Peyry's drafting tool was a conforming device, although it could be used flat like the McDowell machine as well as by placing it on the customer. In either case, the first steps were the same. Twelve measurements (including the hip circumference) were taken with a tape measure to draft a "basque." Nine more were required for the sleeve and five for the skirt. The plates making up each frame were adjusted according to the corresponding horizontal or vertical measurements. Then the frames could be used to draft the patterns. Peyry claimed that using his device this way gave "a perfect fit just the same, and thus fully provides for persons who will object to have [sic] the Conformateur fitted on their body" (1904:1). Alternatively, the dressmaker could hook the adjusted frames together and fit them more closely to her customer (Figure 47). After completing these fine adjustments, the dressmaker removed the frames, unhooked them and laid them flat on the material.

I doubt that Peyry's invention became popular in the United States. Any advantage the Frenchman's conforming tool may have had over the McDowell

machine was diminished by the tedious procedures necessary to adjust the less efficiently designed Peyry device. Also, the Peyry "conformateur" was calibrated for metric measurements, while dressmakers in the United States were more accustomed to working in inches.

The "Impression System" of garment drafting, published by the Zenith Manufacturing Company in Rochester, New York, in 1904, used a conforming tool called a "measurer" (Figure 48a,b). This device was described in the patent specifications

FIGURE 46. In 1885 William Bloomer Pollock of Philadelphia was granted patents in the United States (320,496) and Britain for this conforming device, which could be taken apart and laid flat. (U.S. Patent Office.)

Measuring Instruments

Neck Band and Waist Band

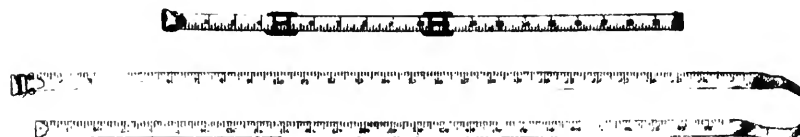

No. 1

Measurer

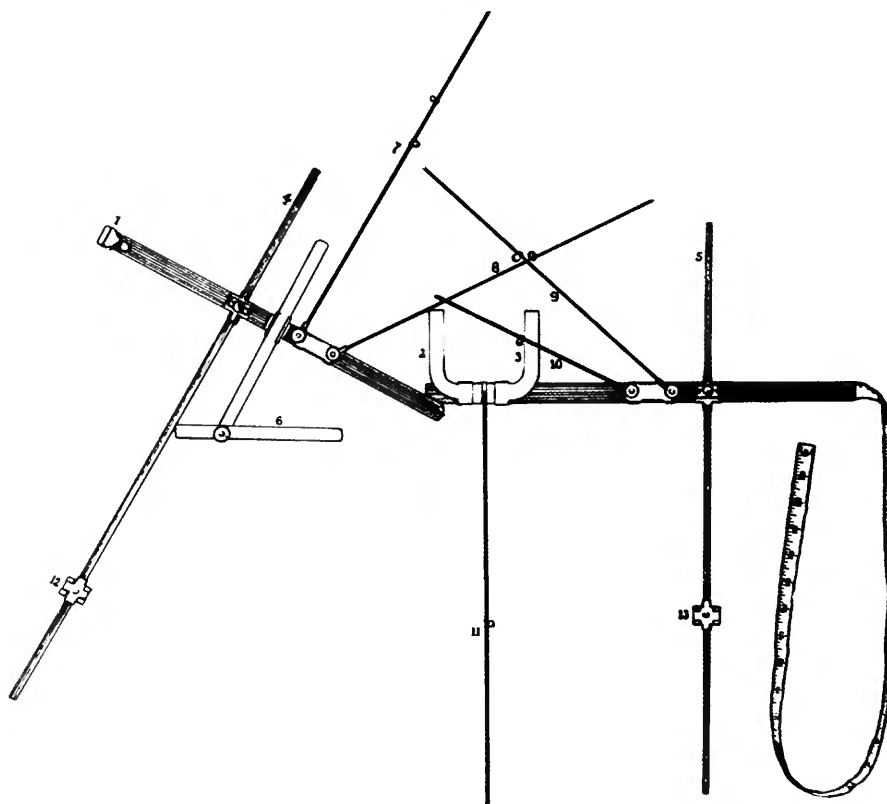

No. 2

1—Measuring Band
2—Front of Arm Bar
3—Back of Arm Bar
4—Front Sliding Bar

5—Back Sliding Bar
6—Dart Bar
7—Back of Neck Pivot Bar
8—Front Shoulder Pivot Bar

9—Back Shoulder Pivot Bar
10—Width of Back Pivot Bar
11—Under Arm Pivot Bar
12 and 13—Measuring Slides

FIGURE 48a-c. The "Impression System" issued by the Zenith Manufacturing Company in Rochester, New York, in 1904, as illustrated in their 1904 instruction book. The neck and waist bands and the "Measurer" were adjusted to fit the customer's figure. The "Measurer" was then laid flat on the pattern paper and served as a guide to marking 12 critical drafting points. Additional tools were provided for completing the draft. (Library of Congress.)

FIGURE 48a. Measuring instruments.

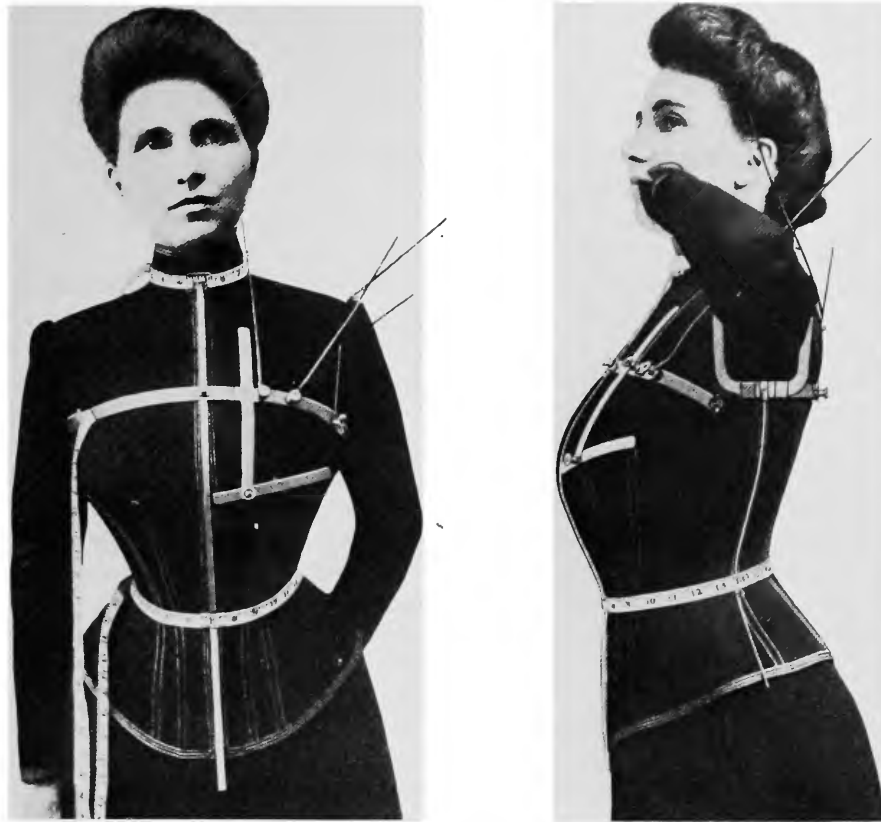
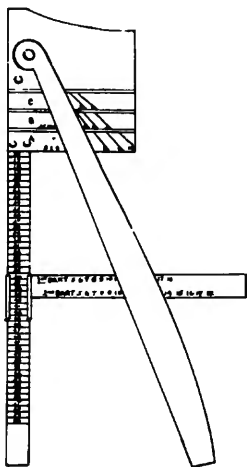

FIGURE 48b. Front and side view of measurements being taken by the "Impression System."

FIGURE 48c. Drafting tools. The "Indicator" helped the dressmaker apportion some circumferential dimensions. The back neck curve of the "Curve Scale" was also marked with an apportioning scale. The other curves on this tool helped the dressmaker draw the curved shoulder and bust darts. The markings helped her determine the lengths of these lines. The "Sliding Spring Rule" and the "Combination Ratchet and Skirt Rule" were used as drawing aids. The former was used for neck curves, armholes, and the tops of sleeves while the latter was suited to drafting the longer vertical curves of the pattern.

Indicator



Curve Scale

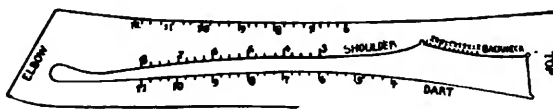

Sliding Spring Rule

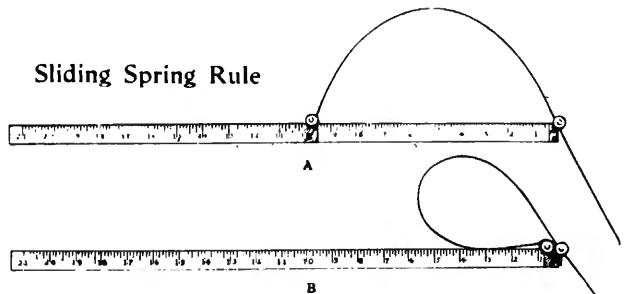

Combination Ratchet and Skirt Rule

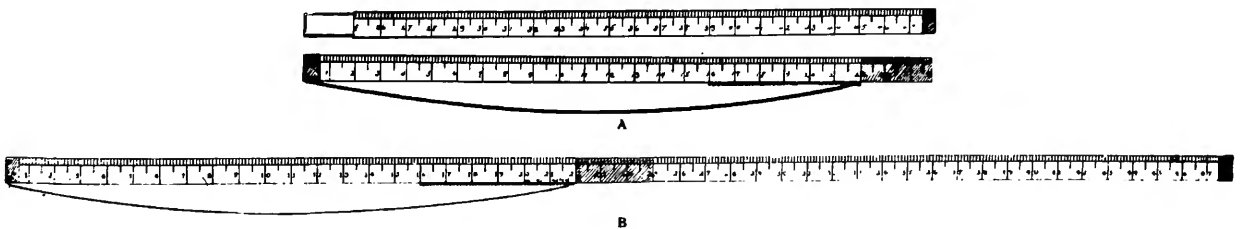

submitted by Edward P. Follett in 1901 as being “adapted to taking measures and locating all the cardinal points necessary in laying out waist-fitting garments” (U.S. Patent 692,510:1). This was an overstatement. The Zenith System also required a “neck band” and a “waist band” (Figure 48a) to take these two critical body measurements and an ordinary tape measure to determine the fullest part of the bust.

The drafting process for this system used the conforming “measurer” to establish the placement of 12 critical drafting points on the pattern paper as well as one line defining the height and slope of the bust darts. Four other tools, however, were needed to locate other drafting points or to draw the subtly curved lines defining the outlines of the pattern pieces. An “indicator” helped to apportion waist and bust dimensions (Figure 48c). Follett was granted a patent for this tool on 11 August 1903 (U.S. Patent 735,738). A “curve scale” (Figure 48c) was used to draw shoulder and bust dart curves, while a “sliding spring rule” (Figure 48c) was an aid to drawing the neck and armhole curves and a “combination ratchet and skirt rule” (Figure 48c) helped to establish the long graceful curves needed for the sides of the four pattern pieces—front,

underarm, side-back, and back.

The patent granted Edward Follett in 1902 for the “measurer” (Figure 48a,b) and another in 1903 for the “indicator” (Figure 48c) were the last in a series of seven patents granted to Follett. (He assigned the last one to the Zenith Manufacturing Company.) He had applied for his first two patents in 1886. The first was for a perforated tool used in a direct-measure system for drafting sleeves (U.S. Patent 389,376). The second was for an adjustable, perforated tool for a direct-measure method of cutting basques (U.S. Patent 389,377). I doubt if Follett was aware that the perforations in his tools were probably first used by the creator of the pre-Tentler proportional dressmakers’ drafting system (Figure 16a). Nor do I think Follett realized, when he abandoned perforated tools in favor of his conforming “measurer,” that he created a tool similar to many early 19th century tailors’ measuring apparatus (Figure 7). Follett’s inventions illustrate that the basic principles behind drafting systems and the specific characteristics of the tools were reapplied independently in new ways as each succeeding generation of dressmakers and tailors attempted to create the ultimate system for cutting a fashionable fit.

Selling the Systems

The manufacturers of drafting systems used every means available to sell their methods. These efforts were directed toward two major objectives—the first to establish the credentials of the system and the second to recruit agents. If one were to believe the rhetoric of the proponents of dressmakers’ drafting systems, one would think that these innovators were all professors, mathematicians, medical doctors, or highly experienced French dressmakers. The condescending tone of some of their instruction books implied that the novice dressmaker should be gratefully eager to spend her money for such expert knowledge.

Many of these “professional” identities were assumed in order to sell products to untutored 19th century Americans who were very much in awe of anything scientific or French. The increasing numbers of late 19th century instruction booklets that made no such claims cast aspersions on the credibility of their more presumptuous competitors.

A McDowell advertising leaflet accurately explained that the French cut dresses by the old method of pinning the lining on the customer. This source observed, “How few people in the country know how the French fit dresses . . . but here every old chart is called a French system. They use the word ‘French’ to catch the ignorant” (A. McDowell & Co., 1892?). One example of this practice was “Madame Demorest.” The successfully diversified “fashion emporium” known as Madame Demorest’s was, in fact, established by Mr. William J. Demorest (as he was always called) and his wife, the former Margaret Willamina Poole. When she died in 1857 the name “Madame Demorest” did not. About 14 months later, Mr. Demorest married Ellen Louise Curtis, who then gracefully personified the title. Another example is Mrs. E. E. Palmer who in 1886 published an instruction booklet in Baraboo, Wisconsin. Five years and a move to Chicago transformed this

Barabooian into Madame Ellsworth Palmer (Palmer, 1892: cover).

The McDowell advertising leaflet also observed that “the word Professor is just as bad in this line of business. It is almost invariably used by frauds, cheeky people, both men and women, who place it before their own names to make the innocent public think they know something” (A. McDowell, & Co., 1892?).

In reality, the majority of inventors of dressmaker’s drafting systems were either dressmakers or tailors who initially created a cutting method for their own use. Then on their own, or with the encouragement of someone else, their systems were refined and made available to the public.

The 1885 instruction book for Cornwell’s “Self-Fitting System” gives a believable if chauvinistic description of how this hybrid system with a curved perforated tool was developed. As was true of C. E. Mosher’s “Bon Ton Dress Chart,” the Cornwell drafting procedure involved a series of steps requiring the tool to be moved a number of times. The principles of this drafting system were first thought of by Miss Elmira Harroun when she was 16 years old. Her first chart was a rough piece of pasteboard on which the method of fitting the shoulder and determining the size of the darts was marked with pen and ink. It was “a puzzle which no one could figure out until Mr. Cornwell, a practical business man full of inventive faculties, discerning the great value . . . in his wife’s cherished pasteboard, undertook to make it so plain that ‘he who runs may read’” (Cornwell, 1885:4). After six months of study a few charts were printed from a wood cut and after this version was tested, additional improvements were made. Finally in 1870 the first charts were manufactured using a copperplate obtained in New York. In 1876 the first set of improved, colored, nickel engravings of the chart were made (Figure 49a).

Between 1876 and the publication of the 1885 instruction book, additional changes were made. The latest alteration was making the darts smaller and allowing for an underarm dart, “thus meeting the wants of the prevailing style” (Cornwell, 1885:4). Also during this period a “New Improved Sleeve System” was developed (Figure 49b). Four patents and nearly a score of copyrights were claimed.²⁰ The 1885 Cornwell publication also

boasted that, since its modest beginning, over a quarter of a million systems had been sold.

Not every drafting system was the original creation of its proponent; the pirating of systems was a chronic problem from the beginning. Nevertheless, the ostentatious way that the inventors discussed this hazard suggests that they were trying to use it to their advantage. The descriptions of their methods for protecting their creations seemed to have been aimed as much at impressing the reader concerning the value of the system as they were intended to serve as a warning to unscrupulous entrepreneurs. Thus, trading on the old adage “imitation is the highest form of praise,” the seller of a system might try to establish the special value of his technique by dire warnings directed at supposed or would-be plagiarizers. In 1857 Dr. E. P. Minier even went so far as to give the names of some individuals who had “stolen” his system. His way of helping the buyer be sure she had the real “Minier” was by adding his signature to each copy of his tool (Minier, 1857:24). Justin Clavé in 1859 (Figure 17) also followed this practice.

Patenting the tool or, less commonly, the process, increasingly became an accepted practice as shown by the list included in Appendix III. Some individuals, however, found the protection afforded by a copyright to be an attractive alternative because it was less expensive and easier to acquire. Also, some inventors whose tools could be printed on paper included their devices as part of their instruction book which was then copyrighted. This was done even when it was felt that the tool would be more useful if it were made of durable materials. Published instructions for systems such as those of Powell & Kohler (Figure 19a), Mrs. Louisa L. Jackson (Figure 33), and James A. Wilson (Figure 35) recommended that the user remove the paper tool from the book and apply it to stiff cardboard or wood.

Apparently, Nancy and George Norman found their copyright to be effective protection. In 1880 the United States Circuit Court, District of Indiana, awarded them the gains and profits received by several defendants found guilty of unlawful manufacture and sale of copies of their charts and diagrams. A copy of the court’s order and decree was even included in Mrs. Norman’s 1881 instruction booklet. No doubt the readers were impressed.

A more direct way to gain special attention for a system was by entering it in a trade exhibition. It

²⁰ I have located only one patent issued to Willett Cornwell, this one on 22 October 1878 (U.S. Patent 209,111).

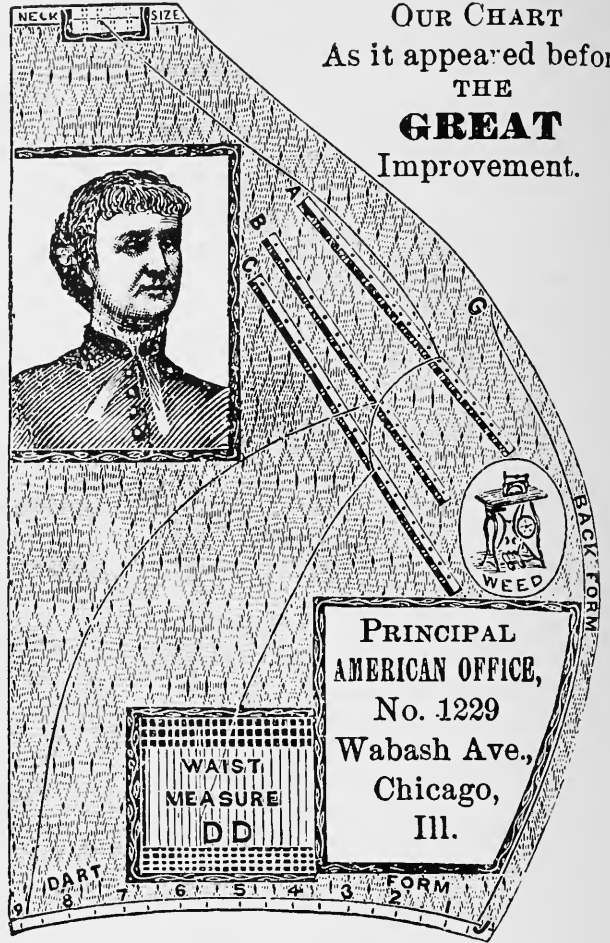
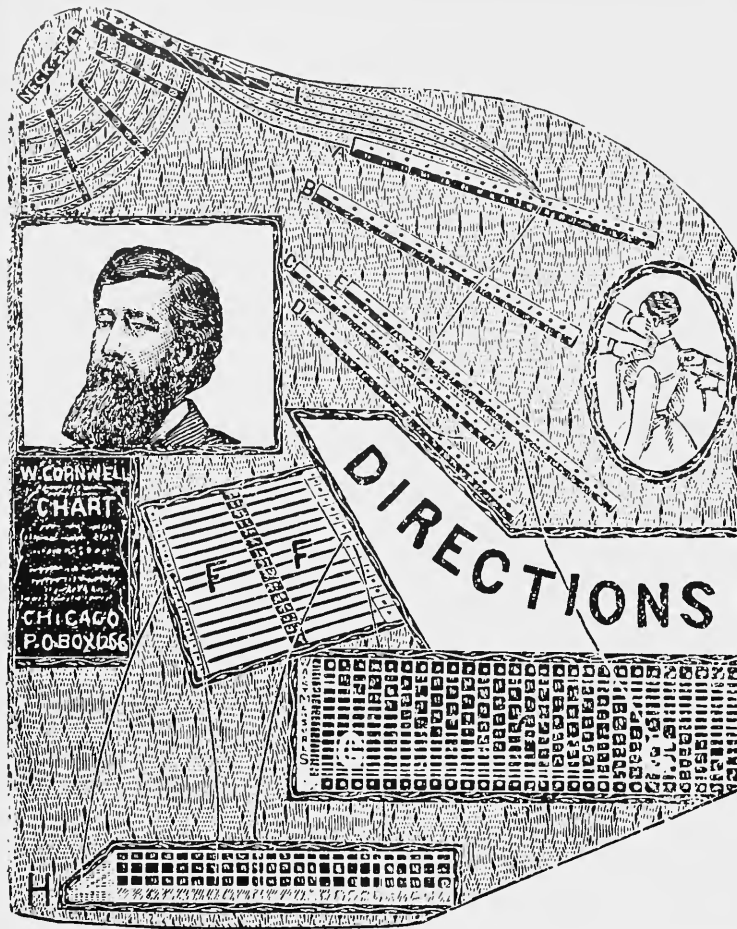

THIS IS A **PHOTO ENGRAVING** of our new Improved Sleeve System which is about 24 in. long by 12 in. wide. Send Stamp for circular.

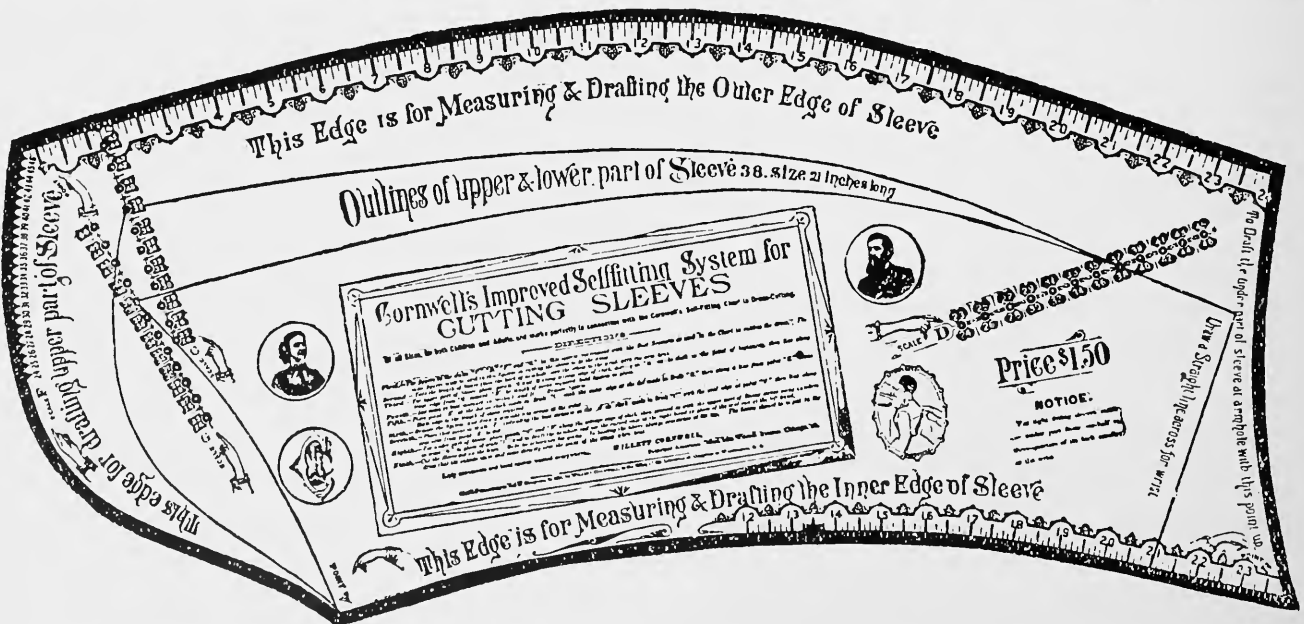

OUR NEW IMPROVED SLEEVE SYSTEM with its figures, holes, curved edges and plain directions, is an **Accurate Rule** for cutting sleeves of all sizes, without refitting, and works perfectly in connection with the Cornwell Chart and Dress-Cutting. Send Stamp for circular.

would be seen by the visitors and there was always a good chance of its being given an award, usually in the form of a medal. This distinction could be advantageously reported by including drawings of the handsome medal in the instruction booklet (Figure 28). Sometimes a facsimile of the award statement was included as well (Figure 50). The sellers of these systems recognized that it is a part of human nature to be impressed by awards. The fact that these were usually given in recognition of individual merit but not of superiority over another system was never mentioned—or was misrepresented (Figure 28). Twelve dressmakers' drafting systems were exhibited at the greatest U.S. fair of all, the 1876 International Exhibition at Philadelphia. Of those mentioned before, Willett Cornwell, Madame Demorest (Figure 51), and Samuel T. Taylor were exhibitors.

Although magazine advertising was not a fully developed selling medium, it was still used. The earliest ads which appeared in *Harper's Bazar* during the last quarter of the 19th century consisted of a few lines of text and perhaps a small illustration. The later advertisements for the McDowell machine (Figure 52) were by far the most effective. They not only extolled the virtues of the system but they offered special inducements to individuals buying directly from them as well as a "come on" for potential agents. McDowell's offer of a free trial period for mail orders was unusual. It is ample proof that the McDowell machine could be easily understood and used. Most systems had to be actively sold. Most techniques had to be demonstrated and the potential buyer offered special cutting lessons before any money changed hands.

Thus, in addition to establishing a distinctive name for itself the manufacturer of each drafting system made a major effort to recruit a network of agents. Frequently the system's instruction book-

FIGURE 49a,b. Cornwell's "Self-Fitting System" as presented in his 1885 instruction booklet. (Library of Congress.)

FIGURE 49a (left, above). An obsolete variation of Cornwell's perforated, curved, two-piece tool for a hybrid drafting system. Mr. Cornwell's picture is shown on the front piece above the title "W. Cornwell's Chart." Mrs. Cornwell, whose picture is shown on the back piece without any identification, was the original creator of this system.

FIGURE 49b (left, below). Advertisement for perforated tool for cutting sleeves by Cornwell's improved hybrid system.

INTERNATIONAL EXHIBITION.

PHILADELPHIA, 1876.

The United States Centennial Commission has examined the report of the Judges, and accepted the following reasons, and decreed an award in conformity therewith.

Philadelphia, Dec. 21st, 1876.

REPORT ON AWARDS.

Product, *Graduated Chart for Dress Cutting.*
Name and address of Exhibitor, *Willett Cornwell,*
No. 153 North Eighth St., Philadelphia, Pa.

The undersigned, having examined the product herein described, respectfully recommends the same to the United States Centennial Commission for Award, for the following reasons, viz:

*Originality, well fitted to
the purpose intended, and
economical in cost.*

W. O. Linthicum,
Signature of the Judge.

APPROVAL OF GROUP JUDGES.

<i>Dietz Monnin,</i>	<i>Modest Kittary,</i>
<i>M. P. Empey,</i>	<i>Kanitz,</i>
<i>B. F. Britton,</i>	<i>Geo. Hewston,</i>
<i>W. H. Chandler,</i>	<i>E. N. Horsford.</i>

A true Copy of the record.

Francis A. Walker,
Chief of the Bureau of Awards.

Given by authority of the United States Centennial Commission.



A. T. GOSHORN,
Director-General.

J. L. CAMPBELL,
Secretary.

J. R. HAWLEY,
President.

FIGURE 50. Facsimile of award given to Willett Cornwell for the drafting system he exhibited in Philadelphia at the 1876 Centennial Exhibition, from Cornwell's 1885 instruction booklet. (Library of Congress.)

lets themselves became an important means for converting the home sewer and dressmaker into an agent. Dr. Minier seemed to suggest a new idea in his 1857 publication when he declared that "both ladies and gentlemen will be privileged with agencies. Ladies shall have the preference and it is hoped on the part of the inventor that they will claim and maintain the entire monopoly" (1857:2). He also reported that Cincinnati would be the "Depot" for his sales to the West and New York City would serve the East. Mrs. D. A. Inwood did not mince words in her 1863 instruction book when she announced, "I want 500 smart and

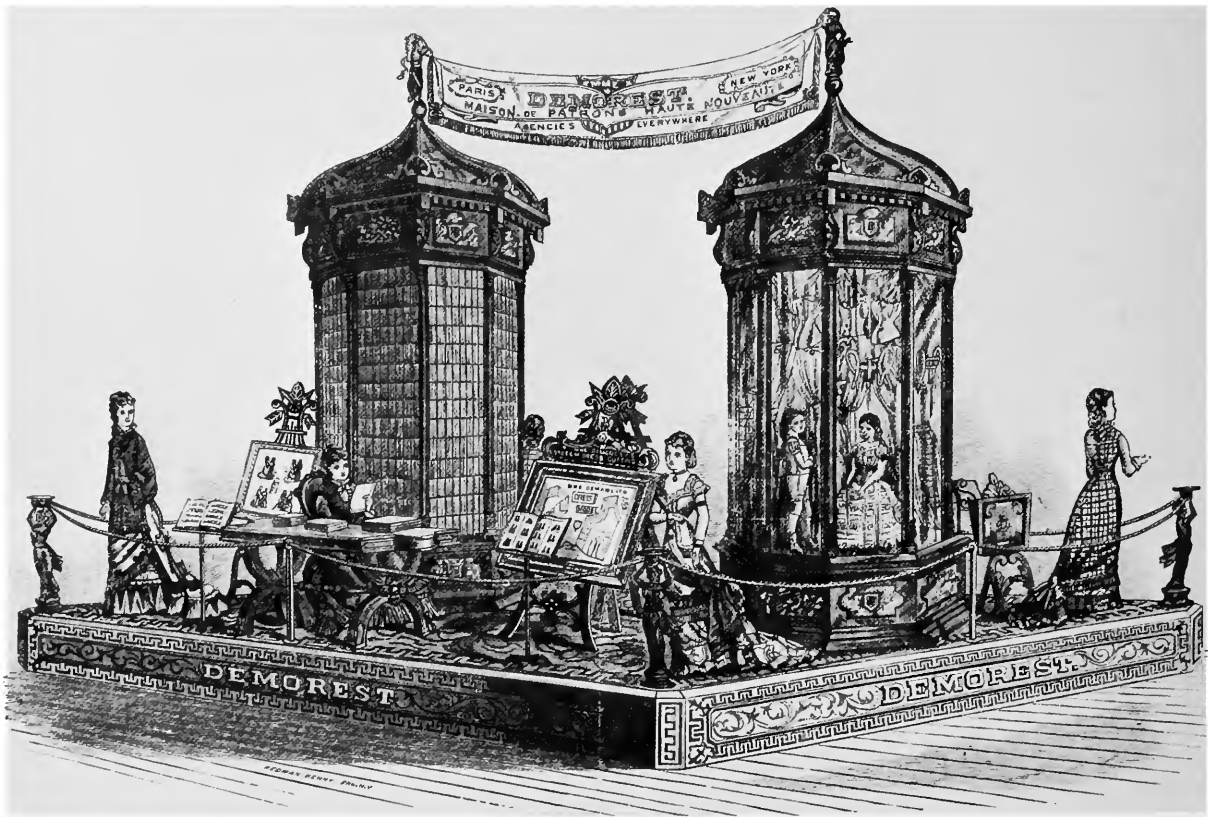

FIGURE 51. Mme. Demorest's exhibit in the main building of the 1876 Centennial Exhibition in Philadelphia, which displayed items reflecting the diverse enterprises of her "Emporium of Fashions," including a large assortment of sized paper patterns shown in the black walnut octagonal case on the left and the perforated drafting tool, called a "Dress Model," mounted on a large easel of walnut and gilt; from June 1876 issue of *Demorest's Monthly Magazine*. (Smithsonian Institution.)

energetic ladies to act as local and traveling Agents throughout the U.S. They can easily clear 6 hundred dollars a year, if diligent to business" (1863:1). She followed up with trade cards announcing "agents wanted" and with a magazine advertisement (*Harper's*, 1873:126).

To entice an individual to sign up as an agent and to give present agents more motivation, a

The Greatest Invention of the Age.

THE McDOWELL
Garment Drafting
MACHINE,
6 W. 14th St., N. Y.

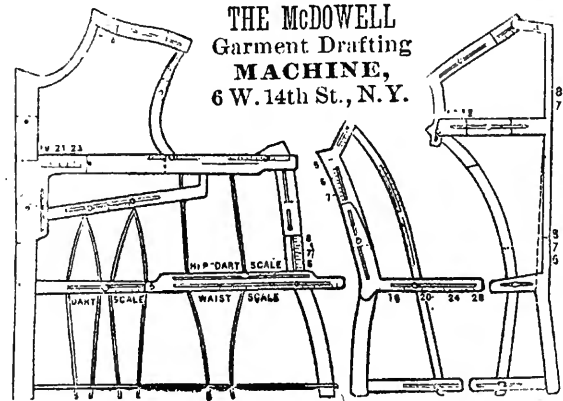

Dressmakers.—This Wonderful Machine drafts perfect garments of every description from Actual Measure, fits all shoulders, and prevents fullness at bottom of front darts. You may send NOW and test Machine at your own home free of charge. Extra inducements to first party in each town securing a Machine. A rare chance for Agents. **THE McDOWELL GARMENT DRAFTING MACHINE CO.**, 6 West 14th St., New York City. For Sale at 459 Washington St., Boston; 1233 Chestnut St., Phila.; and 499 Wabash Avenue, Chicago.

FIGURE 52. McDowell's advertisement, 5.2 × 7.1 cm, from 19 January 1884 issue of *Harper's Bazar*. (Smithsonian Institution.)



FIGURE 53. Obverse and reverse of a late-19th-century trade card, 10.8 × 6.4 cm, advertising for agents. (Smithsonian Institution.)

variety of incentives were devised. Willett Cornwell seems to have used virtually every technique known. The typical testimonial letters published in his 1885 instruction book extolled the virtues of the system, but they especially emphasized the success the writers were having selling the charts—because they worked so well. As a lure, Cornwell offered the “Self-Fitting System” to any individual at the agent’s price of \$2.50 if the buyer thought she might like to try selling the system. The reader was tantalized by the thought that there was no set retail cost of the system; the agent could charge whatever price he wanted. It was said that agents had sold the system for anywhere from \$5.00 to \$12.00. If a woman couldn’t buy a set herself,

however, she need not give up hope. She was given one free if she could induce “some smart business Woman” to send in an order for \$8.00 or more. But if none of this was feasible, a woman could still send Willett Cornwell the names and addresses of all the “Dressmakers, Milliners, School Teachers, Agents, Canvassers and Smart Business Women” she knew. Cornwell promised to send her a reward (Cornwell, 1885). No wonder Cornwell boasted he had over 20,000 agents! To encourage them to keep selling, this resourceful businessman gave premiums such as a gold watch or dress materials to those who met specified quotas within a year. The ultimate prize, a sewing machine, was given to an agent in Fennels, Canada, for selling the great-

FIGURE 54. Agent’s trade card, 13.0 × 6.0 cm, last quarter 19th century. (Smithsonian Institution.)



est number of Cornwell systems in 1884.

While Cornwell's 20,000 agents probably included any individual who had ever expressed a desire to sell his system, the ideal agent was more seriously committed to the enterprise. These agents were advised to canvass dressmakers and ladies everywhere. They demonstrated the system to prospective customers by drafting a costume. Once the sale was made, the agent taught the customer how to use her new drafting tool. Agents were also encouraged to form classes in their rooms or homes where they could teach groups and special private lessons. The more adventurous were urged to travel through towns and cities and advertise to teach dressmaking for short periods at some hotel or central location.

Agents who were serious about selling had personalized trade cards printed that described their particular product (Figure 54). Whenever possible the manufacturers helped to make their agents better known. For example, S. T. Taylor routinely listed the names and addresses of his major agents in his various periodicals. But for many, selling systems was a side line. Established dressmakers might give cutting instructions and sell systems. Dry goods stores or departments might carry a system or two. Sewing machine salesmen might also handle a drafting system or give one free to every purchaser of a machine—a major investment. Who did the selling did not greatly concern manufacturers of the systems. All that mattered was increasing sales.

The Users

Drafting systems for cutting dresses were created in the 19th century for amateur and professional dressmakers. Proportional methods came first, followed by hybrid and then direct-measure techniques. The apparent shifts in the popularity of one method over the others occurred as a response to changing dress fashions as well as a reaction to the appearance of new users of drafting systems.

Amateur Dressmakers

Proportional systems with perforated tools were created in the second quarter of the 19th century to help amateurs cut their own garments. Women of limited means could not afford to pay for the services of a dressmaker. Ready-made garb was a cheaper alternative to made-to-order clothing for their husbands' wardrobes, but no comparable alternative existed for women's dresses (Kidwell and Christman, 1974:53-63). These women had to cut and sew their own clothes to be respectably dressed. According to the morality of that age it was common to regard an individual's appearance as an index of character. In 1844 *The Ladies' Hand Book* declared, "The female who is utterly regardless of her appearance may be safely pronounced deficient in some of the more important qualities which the term 'good character' invariably implies" ("American Lady," 1844:33).

Even though her husband might not be able to

give her adequate funds, a woman of character was still expected to clothe herself and her family "respectably." The simplicity of the proportional systems with perforated tools made these devices superbly suited to meet the needs of these women who were limited by the meager education offered to 19th century "females." The creator of the pre-1838 system might have seen this class of women as a ready market. Also, providing the means for the "less fortunate" to help themselves was a popular philanthropy, reflected by *The Ladies' Hand Book* and others of its kind. Typically, Justin Clavé described his proportional system with a perforated tool (Figure 17) "as susceptible of being understood by families desiring to make their dresses, without the expense of a dressmaker or of any other teaching" (Clavé, 1859).

The early hybrid systems were more accurate than the proportional methods and they were almost as easy to use. They were also intended for the amateur dressmaker. A poem on the back of a Madame Demorest circular extolled the value of a dress cutting system for the home sewer. In June 1854, *Godey's Lady's Book* quoted a poem for the benefit of "all who dread fall and spring dressmaking."

Dressmakers made artists by this magical chart
All flee from the old tedious and wearisome art;
A pleasure succeeds to what once was a task,
As they fashion the jacket, the bodice, and basque.

Each lady with skill now may cut her own dresses,
 When she once the Excelsior Dress Model possesses . . .
 While sitting content in her snug sewing-chair,
 We see the fond mother the dresses prepare.
 She calls up her children and fits them so neatly
 By the children's dress chart that has charmed her completely.

Godey's concluded that "even the old lady 'that lived in a shoe' would find her way out of the difficulties in which she is historically enveloped, by the aid of this magic chart, if it effects half that is promised for it" (Jun 1854:570).

Proportional systems and early hybrid methods were also aimed at the amateur who wanted to turn professional. These were the untrained women who had no one to support them and who wanted more of a future than was possible for a household servant or a seamstress. The systems of the 1850s, 60s, and early 70s were aimed equally at women sewing for themselves and at aspiring dressmakers.

In the 1870s this balanced appeal began to shift. By the last two decades of the 19th century the dress cutting systems were aimed mostly at professional dressmakers. Some methods were still designed partly for women who wanted to make their own dresses, but the emphasis was on selling to the individual wanting to be paid for making garments for others. This shift occurred when the latest fashions dictated precisely fitted garments of the most complex cut and when direct-measure methods (with their greater degree of accuracy and difficulty) became popular. By then, women sewing only for themselves or their families had a simpler way to obtain their patterns; they could buy them from a manufacturer of sized paper patterns.

Paper Pattern Industry

Unsize patterns, proportional systems, and hybrid methods existed before the first mass production of sized paper patterns in the 1860s. Madame Demorest's growing business responded to the changing fashions and technology. In May 1854, *Godey's Lady's Book* reported that Mme. Demorest had patterns for everything in a "lady's under wardrobe" (May 1854:460). A month later *Godey's* also informed its readers of Demorest's drafting system, the "Excelsior Dress Model." The fall 1861 issue of *Mme. Demorest's Quarterly Mirror of Fashion* included advertisements for the dress cutting system, a wide range of unsize patterns, and also trimmed paper patterns that would "furnish an elegant display for a Dress-maker's Show Room" (1861: inside front cover). Three years later the same magazine advertised the same three dressmaking aids plus "waist patterns cut by measure" (cf. Figure 55). This latest offering provided "ladies living at a distance" with waist and jacket patterns custom cut to fit their figures if they sent the cost of the patterns, 20 or 25 cents, with their three measurements—bust, waist, and the under-arm length (Summer 1864: inside back cover). These personalized patterns were probably cut with a simple hybrid system.

The earliest located evidence of Demorest's mass producing sized paper patterns appears in an advertisement in the June 1872 issue of *Demorest's Illustrated Monthly*, which leads off with the declaration, "Something New." These patterns for ladies' and children's dresses are described as "graded in various sizes and put up in illustrated

FIGURE 55. Obverse and reverse of a trade card, 4.8 × 3.2 cm, used by a Boston branch of Mme. Demorest's "Emporium of Fashions" advertising both unsize and custom cut paper patterns, dating probably from the 1860s. (Smithsonian Institution.)

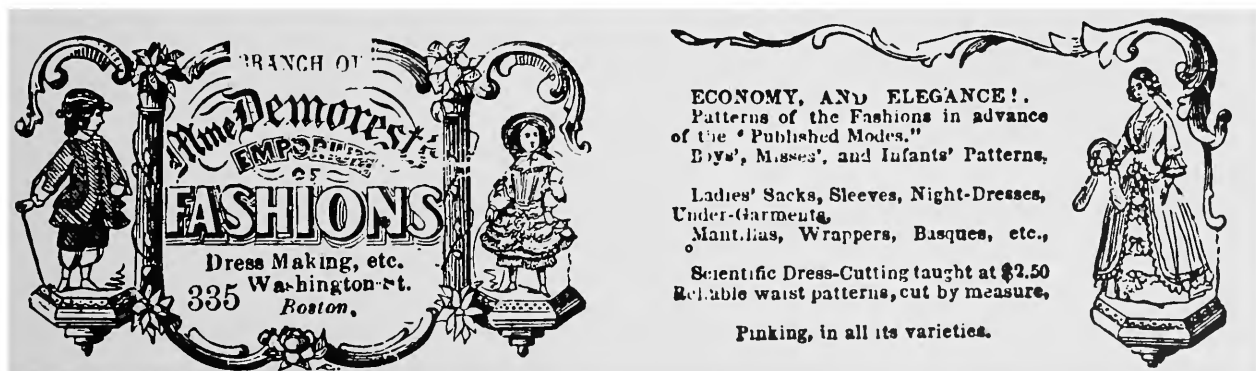



FIGURE 56. Both 1876 costumes were made from the same Demorest sized skirt and polonaise patterns; each pattern cost \$0.30; from August 1876 issue of *Demorest's Monthly Magazine*. (Smithsonian Institution.)

envelopes, with full directions for Making, Trimming, etc., and so accurately cut and notched that any novice can put them together" (Jun 1872: inside front cover). It is not clear whether all these features were "Something New" or only one or two features. Whatever was the case, this "Something New" was new only to Demorest. Five years before this advertisement, E. Butterick & Company started producing paper patterns that were sized, and notched. Also a label was attached to each Butterick pattern printed with an illustration and directions. The present evidence suggests that Demorest was copying Butterick.

The Mme. Demorest display at the 1876 Philadelphia Centennial Exhibition included a dress cutting system with a perforated tool and hundreds of sized paper patterns (Figure 51). In 1877 *Mme. Demorest's What to Wear* reported, "According to the system by which all these patterns are cut, the usual sizes for ladies' fitted patterns are 36, 38, 40 and 42 inches in bust measure" (1877-1878:126).

It is not certain when Demorest made the transition from unsized and custom cut patterns to mass produced sized patterns. Nevertheless the relationship between the drafting system and the sized pattern is clear. The 1877-1878 issue of *Mme. Demorest's What to Wear* declared, "It is now very generally conceded that our system of dress-cutting, by which all the patterns are cut, is founded absolutely on scientific principles, is easily comprehended, and can be adapted to all the changes and caprices of fashion" (1877-1878:126). It was reported that this same system had received the highest prizes wherever exhibited from the 1851 World's Fair in London to the recent 1876 Centennial Exhibition. In other words, the drafting system which Demorest sold to others for cutting their own dress patterns was used by Demorest's cutters to draft mass-produced sized patterns.

Thirty-seven-year-old Ebenezer Butterick made his first patterns in 1863 in Sterling, Massachusetts. Originally trained as a custom tailor, Butterick had gained experience as a merchant tailor in Leominster, Massachusetts, selling yard goods and ready-made clothing. In 1864 he moved to New York and established E. Butterick & Company with J. W. Wilder and A. W. Pollard. In that year the company's first issue of *Boy's Patterns* was published and a year later the first *Semi-Annual Report of Gentlemen's Fashions* appeared.

By 1867 Butterick was producing patterns for



FIGURE 57. Obverse and reverse of trade card, 11.8 × 7.7 cm, used by a New Jersey dry goods store handling Mme. Demorest's sized paper patterns, about 1876. (Smithsonian Institution.)

JAMES LINDSAY,
No. 346 Communipaw Avenue, Jersey City, N. J.,
DEALER IN
DRY & FANCY GOODS
NOTIONS, TOSERY, HAT GLOVES, DRESS TRIMMINGS AND EMBROIDERIES,
A FULL LINE OF GENTS' FURNISHING GOODS.
Ladies' Ready-Made Underwear & Corsets
A SPECIALTY.
BOOTS AND SHOES,
I would call special attention to my Extension Soled Shoes. A call is respectfully solicited.
Agency for Mme. Demorest's Reliable Patterns.

feminine garments illustrated in their first *Ladies' Report of New York Fashions* (as reported in *The Metropolitan*, May 1872:333). These patterns ranged in cost from ten cents for a sleeve to 75 cents for dresses (*Butterick's*, 1867:22-23). They were "designed for the use of persons not very familiar with making garments, and who desire to make them for themselves or their children" (*Butterick's*, 1867:17). In February 1872 *The Metropolitan* reported that at its beginning E. Butterick & Co. had "invented and elaborated a system of graduating patterns to fit all sizes. Others had been hampered by the idea that these things must be done according to correct laws of proportion found in antique statues." The Butterick Company, however, had "recognized the fact that these true proportions are not often found, and by a



962

Lady's Pelisse, with a Surplice Front.
Bust Measures, 28 to 38 ins.
11 sizes: 75 cents each.



114

Lady's Dress, Gored from the Shoulder.
Bust Measures, 23 to 42 ins.
15 sizes: 75 cents each.



958

Lady's Pelisse, with a Diagonal Front.
Bust Measures, 28 to 42 ins.
15 sizes: 75 cents each



874

Lady's Dress, Gored to the Arm Scye.
Bust Measures, 28 to 42 ins.
13 sizes: 50 cents each.



828

Lady's Polonaise Dress.
Bust Measures, 28 to 42 ins.
13 sizes: 75 cents each.



846

Lady's Toilet Suit.
Bust Measures, 23 to 38 ins.
11 sizes: 75 cents each.



800

Lady's Walking Suit, with Pelisse, Apron Front, and Marie Antoinette Cape.
Bust Measures, 28 to 38 ins.
11 sizes: \$1 each.



993

Lady's Dress, with Collar and Lapels, Gored to Arm Scye.
Bust Measures, 28 to 38 ins.
11 sizes: 75 cents each.



86

Lady's Circular Wrapper.
Bust Measures, 28 to 40 ins.
13 sizes: 75 cents each.

FIGURE 58. An assortment of ladies' patterns from the small (11.5 × 19.6 cm), 26-page catalog offered by E. Butterick & Co. about 1869. Patterns of garments for ladies, misses, boys, and little children of both sexes as well as patterns for gentlemen's shirts were included. Each folded tissue pattern had attached to it a printed label showing the size, amount of cloth and trimming required, instructions for cutting and making, and a picture of the finished garment. Any pattern in the catalog could be ordered by mail from any part of the United States or Canada. (Smithsonian Institution.)

series of practical experiments best known to themselves, perfected a system suitable for all" (Feb 1872:124). About 1868, Butterick patterns for a lady's dress were sold in as many as 15 sizes according to the bust measurement which could range from 28 to 42 inches (Figure 58). E. Butterick & Co. created its proportional system to differentiate or "grade" these sizes.

James McCall, a Scotsman, established the second oldest pattern company in operation today. Before he began selling patterns, however, he was in the dressmakers' drafting tool business. Giving his address as 82 Union Street, Glasgow, he obtained a U.S. copyright in 1867 for the "Royal Chart" (Figure 61). This perforated tool for a hybrid system was sold, wholesale and retail, at addresses in Paris, London, Manchester, Glasgow, and New York. For several years, McCall permitted others to handle his business in the United States. In 1867 Russell & Covert of New York advertised the "Royal Chart," describing themselves in *Harper's Bazar* as "Sole Agents for America" (*Harper's*, 1867:14). About a year later, however, O. A. Roorbach of New York advertised McCall's chart (*Harper's*, 1868:943).

James McCall immigrated to New York City about a year later. He was listed in the city directory of 1870 as selling machines at 543 Broadway. He also enthusiastically advertised his chart in the 7 May 1870 issue of *Harper's Bazar*, giving the same Broadway address (1870:303). In 1871 McCall used his exuberant writing style in an advertisement for Elliptic Sewing Machines and another for Bazar Cut Paper Patterns²¹ (*Harper's*,

²¹ McCall's choice of the name "Bazar" for his patterns was probably influenced by his decision to advertise in *Harper's Bazar*. No doubt many readers mistakenly thought that these patterns were associated with the popular magazine. The use of status names to give a fashionable cachet to a new product was common practice in the 19th century as it is today.

1871:671). He announced:

We have carefully prepared a catalogue of 28 pages, containing over two hundred figures, showing the leading fashions of the day. From this catalogue may be selected patterns of every description and of every size, ranging from 30 to 46 inches bust measure; also for misses from 10 to 16 years of age, and for children of both sexes under 10 (*Harper's*, 1871:671).

The Bazar patterns for women were cut by a proportional system, using the "bust" measurement. This system was probably not devised by McCall. He stated, "Every pattern we issue will be the product of the ablest and most experienced gentlemen dressmakers in the country, all under the supervision of Mr. Moschowitz, a gentleman who stands at the head of his profession, and who is unquestionably the ablest dressmaker in the United States. What Worth is to Paris, Moschowitz is to New York—the highest authority on all matters pertaining to fashion" (*Harper's*, 1871:671).

Although only one Moschowitz was mentioned, the proportional system was probably the collaborative creation of the Moschowitz brothers, Herman and Schamu. Both had several patents to their credit. They appear to have taken turns applying for them. Schamu received a patent for an "Improvement in Body-Lining for Ladies Dresses" on 24 January 1871 (U.S. Patent 111,236). Herman received one for "Goods for Dress-Linings Having Pattern Printed Thereon" on 30 August 1881 (U.S. Patent 246,536). Then Schamu was granted a second patent, "Combined Pattern and Fabric," on 6 October 1885 (U.S. Patent 327,961), and Herman obtained his second, "Pattern for Garments," on 30 November 1886 (U.S. Patent 350,073).

McCall's association with Moschowitz continued for a number of years. As late as 1882 McCall published the "French System of Cutting and Fitting" (the third section of a larger publication), which purported to be the system Messrs. Moschowitz and their partner Russell used in their dressmaking business (McCall, 1882, 3:3). McCall described their establishment in New York, as "one of the best and most extensive in the world" employing 90 male dressmakers (1882, 3:1). McCall also declared that "the three greatest artistic dressmakers in the world" were Pingat, Worth, and Moschowitz (1882, 1:3).

In 1884 the Moschowitz brothers expanded their activities, placing themselves in competition

FIGURE 59. "Ladies' Promenade Toilet" made from two 1876 Butterick patterns: a \$0.20 "basque" pattern, in bust measurements 28 to 46 inches and a \$0.35 walking skirt pattern, in waist measurements from 29 to 36 inches; from *E. Butterick & Co.'s Illustrated Catalogue of Patterns, Spring and Summer 1876*. (Butterick Patterns Archives/Library.)



with McCall. They began producing "The Moschcowitz Model Waist Lining" (Moschcowitz, 1884). Their *Harper's Bazar* advertisement described this Silica lining printed with a pattern of a "Lady's" bodice and sleeves as an opportunity to avoid "the expense and use of a paper pattern" (1884:431). This innovation was to be used both as a pattern for cutting out the outer fabric and also as the lining for the dress. These pattern-linings were sold according to the "bust" measurement.

By this time McCall's preferred proportional system differed from the Moschcowitz method. The Moschcowitz customers were advised to take their "measure around the bust under the arm, two inches tighter than the dress is to fit" (*Harper's*, 1884:431). In 1884, however, the McCall customers were directed to measure themselves by passing "a tape measure around the breast, just under the arms, and above the bust . . . draw it one inch tighter than the dress is to fit" (*McCall's*, 1884–1885:16). In 1884 the McCall's *Bazar* patterns for women's dresses were sold in five sizes, 32 to 40 inches (Figure 62).

Demorest's, Butterick's, and McCall's patterns were all sized by proportional systems of grading. To produce a fashionably shaped garment in the last quarter of the 19th century most women found that these sized (proportionally graded) patterns had to be altered to fit. Various ways to simplify these alterations were suggested to such customers. In 1876 *Peterson's Magazine* described how to draft a basic pattern by a direct-measure technique using just a tape measure. According to *Peterson's*, any commercial pattern could be easily modified to fit with this perfectly fitting home-made pattern as a reference (1876:371). A. Burdette Smith offered a similar solution to her 1877–78 fall and winter pattern catalogue. She recommended that an individual order from her a dress pattern cut for the customer's specific "bust" measurement, circumference of the waist, and the center back length of waist. These custom made patterns were probably drafted by Smith's hybrid system, which used the

FIGURE 60. Modish 1901 reception gowns made from two different "waist" and skirt patterns. The "waist" patterns cost \$0.20 each in six sizes for the ladies from 30- to 40-inch bust measurement. The skirt patterns cost \$0.25 each in seven sizes from 20- to 32-inch waist measurement. From August 1901 Butterick magazine *The Delineator*. (Smithsonian Institution.)



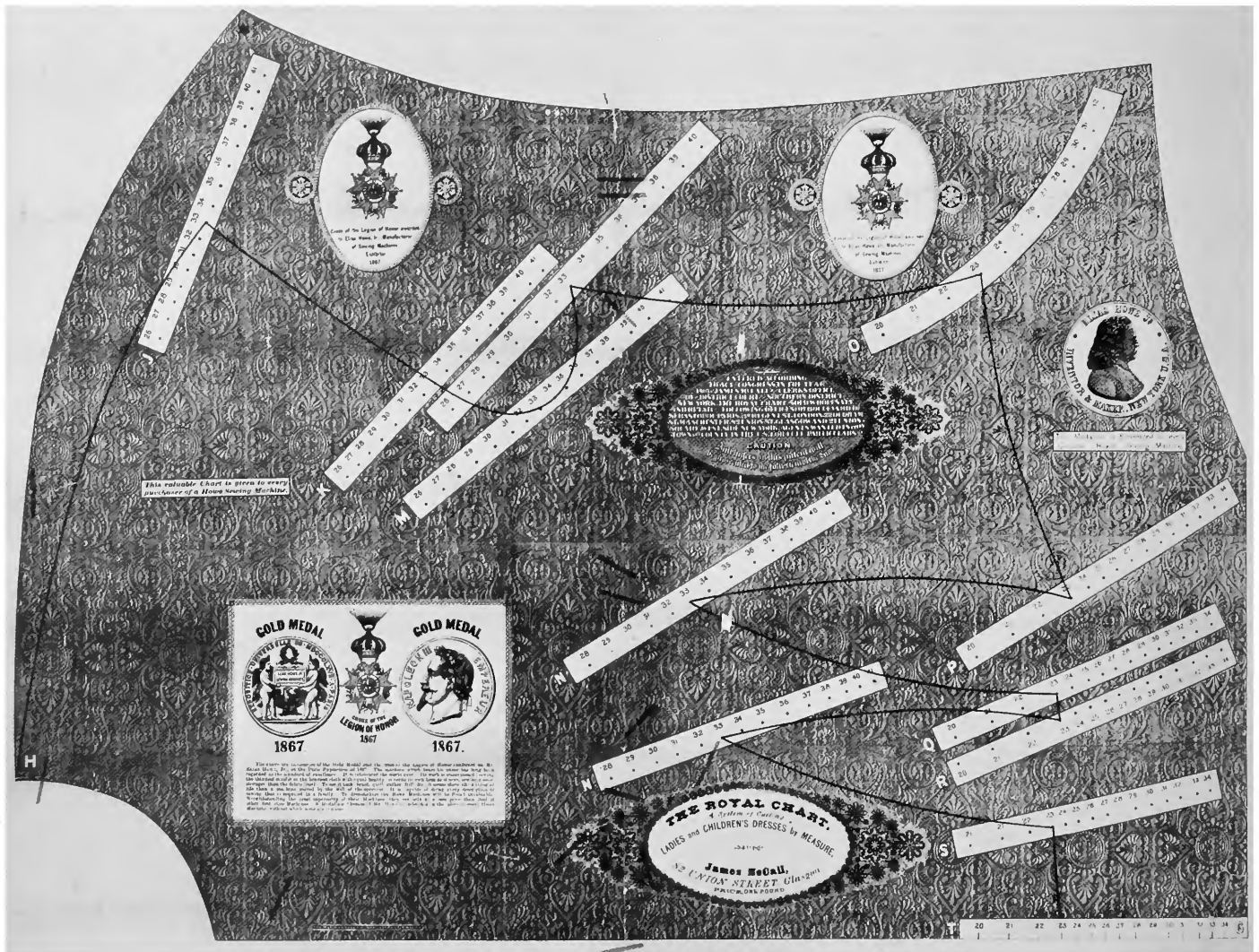

FIGURE 61. "The Royal Chart," a perforated, cardboard tool (47.0 × 62.2 cm) for a hybrid system, copyright by James McCall of Glasgow, Scotland. The illustrated medals represented awards given to Elias Howe, Jr., inventor and manufacturer of sewing machines. For a short period of time McCall's "Royal Chart" was given to every purchaser of a Howe sewing machine. (Prints and Photographs Division, Library of Congress.)

same measurements (*The Elite Dressmaker*, 1878:35). Smith advised her readers that after obtaining a waist pattern custom cut to fit, they could order any other patterns by bust measurement only, "as the pattern that fits can always be used to the waistline, no matter what shape is desired for the skirt portion of the basque or

polonaise' (Smith, 1877–1878:2). This was a reasonable solution as the basic fashionable cut of the dress bodice was essentially the same. Variations between costumes appeared principally in different designs for the basque or polonaise—upper torso garments having skirt-like appendages extending below the waistline. Similar alternatives

1833.—Lady's Polonaise. 5 sizes, 32 to 40 ins. 8 yds. 35 cts. ea.

1798.—Lady's Polonaise. 5 sizes, 32 to 40 ins. 8½ yds. 35 c.

1854.—Lady's Polonaise. 5 sizes, 32 to 40 ins. 8½ yds. 35 cts.

1895.—Lady's Polonaise. 5 sizes, 32 to 40 ins. 7¼ yds. 25 cts.

1817.—Lady's Polonaise. 5 sizes, 32 to 40 ins. 8 yds. 35 cts. ea.

1886.—Lady's Polonaise. 5 sizes, 32 to 40 ins. 9½ yds. 30 cents.

1701.—Lady's Coat. 5 sizes, 32 to 40 ins. 4½ yds. 30 cents each.

2023.—Lady's Redingote. 5 sizes, 32 to 40 ins. 9 yds. 25 cts. ea.

2179.—Lady's Redingote. 5 sizes, 32 to 40 ins. 5¾ yds. 30 cts.

1978.—Lady's Redingote. 5 sizes, 32 to 40 ins. 7 yds. 25 cts. each.

2009.—Lady's Redingote. 5 sizes, 32 to 40 ins. 6½ yds. 25 cts.

1612.—Lady's Redingote. 5 sizes, 32 to 40 ins. 6 yds. 35 cts. ea.

2178.—Lady's Princess Dress. 5 sizes, 32 to 40 ins. 16½ yds. 30c.

2040.—Lady's Princess Dress. 5 sizes, 32 to 40 ins. 13 yds. 25c.

1920.—Lady's Princess Dress. 5 sizes, 32 to 40 ins. 15 yds. 35 cts. ea.

1807.—Lady's Costume. 5 sizes, 32 to 40 ins. 15 yds. 35 cts.

1809.—Lady's Costume. 5 sizes, 32 to 40 ins. 18 yds. 35 cents each.

1618.—Lady's Walking Costume. 5 sizes, 32 to 40 ins. 14 yds. 35 c.

1612.—Lady's Princess Dress. 5 sizes, 32 to 40 ins. 13¾ yds. 35c.

2165.—Lady's Mother Hubbard Wrapper. 5 sizes, 32 to 40. 11 yds 30c.

2015.—Lady's Wrapper. 5 sizes, 32 to 40 ins. 9½ yds. 25 cts.

1666.—Lady's Shirred Wrapper. 5 sizes, 32 to 40 ins. 9½ yds. 25 cts.

2001.—Lady's Wrapper. 5 sizes, 32 to 40 ins. 11 yds. 25 cts.

1641.—Lady's Walking Dress. 5 sizes, 32 to 40 ins. 11¼ yds. 35 cts.

FIGURE 62. A selection of McCall's patterns for ladies' polonaises, coats, redingotes, dresses, costumes, and wrappers, which were usually offered in five sizes from 32- to 40-inch bust measurement. Customers were advised to take this measurement by passing a "tape measure around the breast, just under the arms, and above the bust . . . draw it one inch tighter than the dress is to fit." From the 1884-1885 Fall and Winter Catalog, *McCall's Bazar Glove-Fitting Patterns*. (Warshaw Collection, Smithsonian Institution.)

were offered by some others during the last quarter of the century. Despite the common occurrence of fitting problems which such alternatives reflected, the majority of commercially made patterns were mass produced with proportionally determined sizes.

Even with their limitations, sized paper patterns were popular. Butterick boasted that he was selling four million patterns in the United States in 1871 (*Metropolitan*, May 1872:333). In 1876 Demorest claimed that "one ton of these patterns were recently shipped to London to fill a single order, and 25,000 is not an unusual number to sell at the retail house, 17 East Fourteenth Street, of one style alone during the season" (*Demorest's Monthly*, Dec 1876:643). The wide range of styles offered in the numerous pattern catalogues provided the amateur sewer with a varied choice. If she were clever and if her fitting problems were not severe, she could adjust the waist pattern to fit her. The shapes and arrangements of fashionably trimmed and draped skirts were already calculated for her. She still had to sew the garment. She did not have to know how to draft it.

Professional Dressmakers and Cutters

In the last quarter of the 19th century, drafting systems were used most frequently by professional dressmakers. In 1886 Mme. Mallison said that amateur dressmakers could use her system to cut dresses without "bought patterns." She made a stronger appeal to "young ladies" to whom the Mallison system would be "the royal road to excellence in dressmaking, without having to serve their time with a professional dressmaker to learn the trade." But she promised professional dressmakers that the system would be "what 'they long have sought, and mourned because they found it not,' a simple method of Dress-cutting that will not require re-fitting or alteration of any kind" (Mallison, 1886:6-7).

A woman could be employed as a dressmaker in several ways. She could work in her customer's home or in her own domicile. She could be the head of her own small business employing several other women or she could be a cutter in a major dressmaking establishment. Emma Eckhart and Marie E. Duval exemplified the work of many rural dressmakers.

Emma Eckhart bought a "McDowell Garment Drafting Machine" and a "McDowell Sleeve Ma-

chine," about 1890, when she was 19. She lived and worked in a rural area north of Allentown, Pennsylvania. The villages that are mentioned in her measure book and that can be located on a modern map—Carbon, Little Gap, Aquaschicola, Bowmanstown, and Leighton—are clustered in an area with a five mile radius. Occasionally she traveled about 15 miles to work for relatives in Allentown, the closest large town. Customers frequently picked her up, provided her with room and board while she worked and took her home again when she finished. Emma Eckhart did much less dressmaking after 1909 when her sister-in-law died. At that time she moved in with her brother to help raise his family.²² Miss Eckhart's measure book contains 213 undated entries (Figure 63).

Marie E. Duval bought a variety of Professor J. B. Plant's specialized systems (Figures 24-26) about 1902 when she was 26. She lived in Ludlow and later in Indian Orchard, Massachusetts. She worked in her home making clothes for herself, her five daughters, and for her customers. One daughter recalls her saying that a well dressed woman would have two ensembles made a year, one winter and one summer. Each costume consisted of a coat, hat, and dress.²³ Mrs. Duval could make the entire ensemble.

Many women in cities worked independently as dressmakers as did Miss Eckhart and Mrs. Duval. In densely populated areas, however, there was a greater chance of being successful enough to establish a business. In 1894 *The Women's Book* reported nearly four hundred dressmakers in New York City who worked in their own "flats" and employed from two to ten assistants. These women did not make fortunes, it was said, but "they appear to make a comfortable living" (Hubert, 1894:62).

The individual dressmaker working for herself performed all the manufacturing tasks. When a dressmaker could afford to hire assistants she continued to do the cutting and fitting while relegating the more routine tasks of basting, sewing, and trimming to her employees. The larger the establishment the greater the degree of specialization.

²²I am grateful to Mrs. Helen O. George for obtaining background information on Emma Eckhart.

²³I am grateful to Annette J. Gibbs for providing background information concerning her mother, Marie E. Duval.

In the largest custom shops there was no one called a "dressmaker." Instead the critical tasks of dealing with the customer and drafting the pattern were assigned to two different people. The saleswoman waited on the customer, helping her to select the style of garment, the fabric and trimming. This saleswoman also measured the customer and sometimes worked with her during the fittings.

Drafting the pattern from the measurements taken by the saleswoman was the work of a specialist, the cutter. Samuel T. Taylor wrote in 1867 that "the increasing demand for good cutters by the system are without parallel in the history of nations." The demand for them was so great that they were being paid from \$15 to \$20 per week (*Le Petit Messenger*, 1867:153). Twenty-nine years later, the instruction booklet for Taylor's dress cutting system included 67 testimonial letters from dressmakers, cutters, and employers of cutters. Annie C. Zaun, a cutter and fitter, thanked S. T. Taylor for recommending her to the Washington, D.C., department store Woodward and Lothrop: "Of all the several positions I have had, this is by far the most excellent. The pay be \$35.00 per week and the firm don't fail to make everything agreeable and pleasant for me" (1896:50). Mrs. H. L. Frazier of Montgomery, Alabama, expressed her appreciation to S. T. Taylor for sending her a good cutter: "Have tried her now for quite a few weeks and find she used the system perfectly. I must say there is no system gives such entire satisfaction as the S. T. Taylor. Having used it now for twelve years, would not exchange for any other, neither would I engage any in my workrooms but what use it" (1896:51). On 25 November 1891, Albert McDowell, president of the McDowell Garment Drafting Machine Company, certified that Miss Lillian Duncan had completed a course of instruction in cutting ladies' garments in New York City (Figure 43c). He wrote that, with practice, she "should be fully competent to do first class work as a dressmaker or to take a good position as a cutter." Employment as a cutter was available to women with training.

The cutter did not deal directly with the customer. She worked only with the customer's measurements. This is particularly apparent in mail-order custom work in which most of the department stores were engaged. The catalog frequently did not illustrate the style of the garment the store

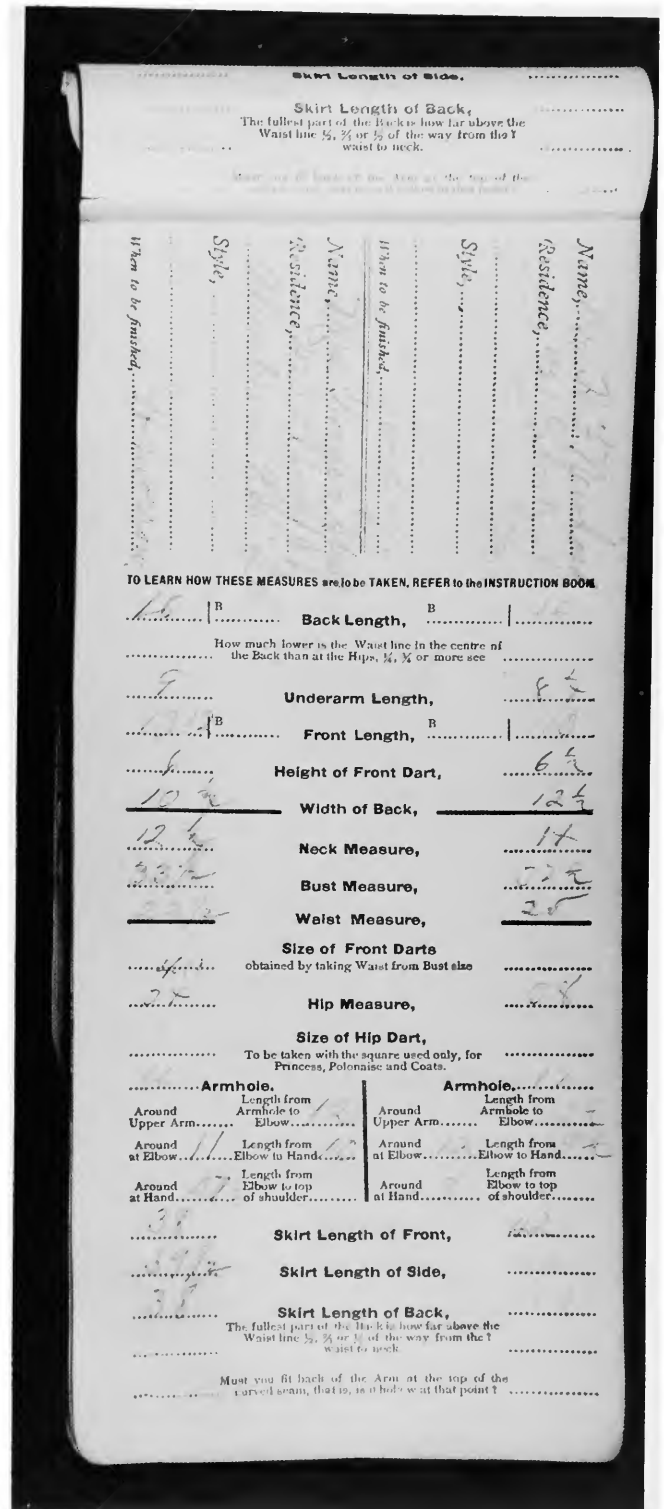
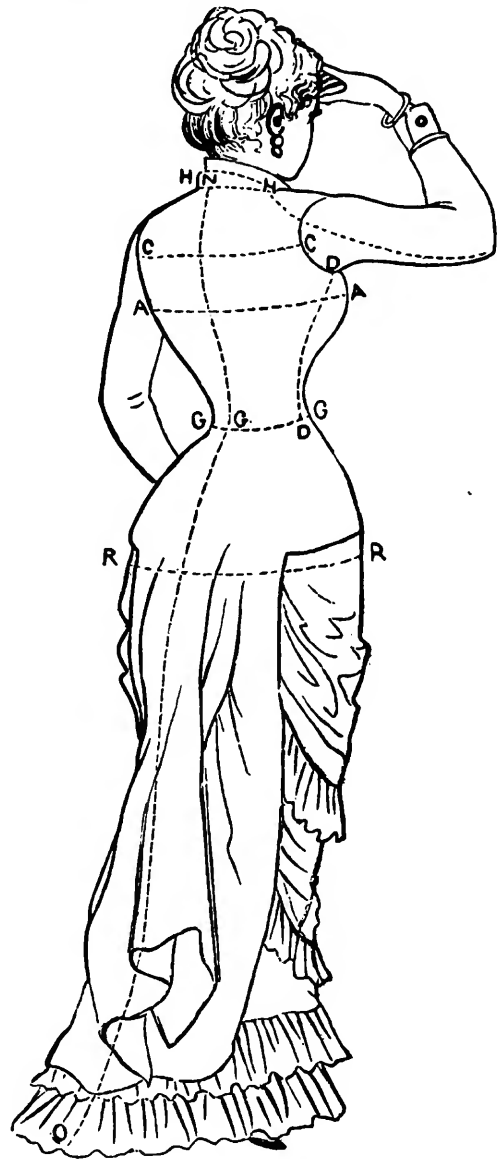

FIGURE 63. Two customers' measurements recorded in a McDowell measure book by Emma Eckhart. (Smithsonian Institution.)

INSTRUCTIONS FOR MEASURING.



Take the following measures over the dress, rather closely.

- 1 Around the bust, at the largest part, under the arms, A A A A.
- 2 From sleeve-seam to sleeve-seam across chest, being the width between shoulders across chest, B B.
- 3 From sleeve-seam to sleeve-seam across the back, being width between shoulders across back, C C.
- 4 From sleeve-seam under arm straight down to waist-seam, D D.
- 5 Length of sleeve on the inside seam, E E.
- 6 Length of sleeve outside, viz.: from junction of sleeve-seam with shoulder-seam, at back of shoulder, to point of elbow thence to wrist, K F F.
- 7 Around waist, G N G G G G.
- 8 Around neck at collar-seam, H N H H N.
- 9 Around hips at the largest part, R R R R.
- 10 Length of shoulder-seam from collar-seam to sleeve-seam, H K.
- 11 From neck to waist-seam in front, N N.
- 12 From neck to waist-seam at the back, N G.
- 13 Length of skirt in front, not including the band, N P.
- 14 Length of skirt at back, not including the band, G Q.
- 15 Size of arm where sleeve joins waist.
- 16 Size of arm just above elbow.

If the bust measure is taken too high in front and too low behind, or otherwise than as directed, an error of one or two inches will result.

If you stoop, when measured for length of skirt, the measure will be two inches short.

A waist-lining, made to fit as you would like it, would be preferred.

offered to make. Instead detailed descriptions were provided and swatches of the materials were sent on request, sometimes with illustrations of the style. The catalog, however, always gave the customer detailed, illustrated instructions as to how to take the measurements she was to send in (Figure 64). The cutter's draft was only as good as the measurements she was given. Since the customer provided the measurements in the mail-order business rather than a trained saleswoman, the client was also frequently asked to send in an old lining or "waist" that fit well.

During most of the last quarter of the 19th century, direct-measure systems were popularly used by dressmakers and cutters. The extraordinarily close fit of fashionable "waists," "basques," and polonaises demanded more precise and complex cutting than in any other period. American women would not tolerate either the cost or the time required to create a garment by the "pin-to-the-form" technique. And proportional and hybrid systems, which, in the form of sized paper patterns, met the needs and abilities of home sewers, did not work well enough to satisfy the requirements of either the dressmaker or her customer. Hybrids, however, did not disappear; they were disguised. McDowell's 1883 instruction booklet accurately reported that "while most of these systems and charts claimed to give actual measures, nine out of ten were merely proportional scales, some on pasteboard ... and others on tapes and squares ..." (1883:4).

By the early 1890s the elaborately draped skirts of previous decades had evolved into a gored skirt. This style was simpler in appearance but more difficult to cut. Skirt drafting systems were created to solve this cutting problem. Fashions of the early 20th century called for skirts that were even more precisely fitted over the hips to emphasize the roundness of the wearer's *derrière*. Numerous drafting systems for skirts were then created.

FIGURE 64. Detailed instructions to customers for taking the measurements they were to send in when they ordered custom-made costumes by mail from Lord and Taylor. Because of the uncertain accuracy of measurements taken by their customers, the store requested to be sent, "a waistlining, made to fit as you would like it." From *Lord and Taylor Catalog*, Spring and Summer 1883. (Warshaw Collection, Smithsonian Institution.)

Much has been written about shifting erogenous zones. The theory holds that women's clothing fashions focus sexual attention on a specific part of the body. When fashions change, this sexual attention shifts to another part of the body. The major changes in the late 1890s illustrate this phenomenon. As the hips were delineated by the cut of the skirt, the bust became obscured, although still prominent, beneath gathered and loosely draped light weight materials (Figure 60).

Appearances are sometimes deceiving. The outer fabric of this dress bodice was actually draped over a closely fitted lining. Drafting systems were needed to cut the lining and they were used for cutting the outer fabric. The tight fitting lining, however, did not have to be cut as precisely as was required by earlier styles because it was covered by the loosely arranged outer fabric. Hybrid drafting systems emerged again. Because of the new fashions, hybrid methods as well as direct-measure techniques were used by dressmakers and cutters in the early 20th century.

Ladies' Tailors

Drafting systems for women's garments were also used by a comparatively new professional, the ladies' tailor. Charles J. Stone wrote in his instruction booklet of 1901, "This century is opening with the outlook for business brighter than ever before, and especially is this true in regard to Ladies' Tailoring. In these days of progress this department of the trade is making an earnest bid for its share of recognition in the sartorial art" (1901:vii).

Women's tailored suits appeared in the well dressed woman's wardrobe in the 1880s. The early history of their use is obscured by the widespread application of the term "suit" to refer to other types of apparel. The department store catalogues showed two-piece garments that were made by dressmakers. These garments might be called costumes, ensembles, or dresses, but frequently they were referred to as suits. The term was used to mean an outfit consisting of more than one piece but with all parts made of the same material. By the 1890s tailored suits were distinctly different from dresses. Like the riding habit, they exhibited some design elements derived from men's wear and they were made using materials and techniques that were better known to the tailoring trade than to the dressmaking business. Ladies' tailors were usually

LADIES' DRESSES (READY-MADE).

The dresses illustrated on this page are made in proportionate sizes, and can only accept the following measurements: bust, waist and skirt length in front. No samples accepted or sent. Four to six days' time will be required to fill orders.



Fig. 93. Plain and striped suiting in combination, gobelin blue, navy blue or green.....\$19.50

Fig. 94. Cashmere, in all colors and black.....\$20.00

Fig. 95. Gray, brown or blue suiting, plain and stripe.....\$21.00

Fig. 96. Black, brown, blue, green or gray serge, trimmed with gilt or black gimp.....\$22.50

FIGURE 65. A selection of women's ready-made dresses offered in B. Altman & Co.'s fall and winter 1888-1889 mail-order catalog. The "basques" of these costumes were cut with a simple hybrid system using the bust and waist measurements. A lady had to be properly proportioned in order to have one of these ready-made dresses fit. (Warsaw Collection, Smithsonian Institution.)

men who were trained in the art of tailoring and who chose to specialize in this branch of the trade. The tailored suit became so popular as street or business attire in the early 20th century that it diminished the importance of daytime dresses in a woman's wardrobe.

By the 20th century a number of systems created for drafting women's garments were devised as much for ladies' tailors as they were intended for dressmakers.

Ready-made Clothing Industry

Fashions changed, hybrid systems were again openly proselytized, and there were shifts in the importance of one kind of custom work relative to

another. These were minor changes in comparison to the effect which the "ready-made" industry was having on the custom trade.

By the 1850s a wide choice of ready-made clothing was available to men but not to women (Kidwell

FIGURE 66a,b. Excerpts from *Stern Brother's Catalogue*, Spring and Summer 1898. (Warsaw Collection, Smithsonian Institution.)

FIGURE 66a. Four ready-made costumes (Nos. 33, 35, 37, 39) were offered in five bust sizes from 34 to 42 inches with skirts varying in front length from 38 to 43 inches. These ready-made outfits ranged in price from \$19.75 to \$38.50, while two made-to-order costumes (styles L, M) cost from \$65.00 to \$90.00.

2 Ladies' Costumes, Ready Made and Made to Order.

Measurements for Costumes to Order, See Page 1.

Sizes in Ready-made Costumes, 34, 36, 38, 40 and 42 Inches, Bust Measure.

Skirt, Front Length, 38 to 43 inches.



No. 33.

No. 35.

No. 37.

No. 39.

Style L.

Style M.

- Style L. Made to order.** Ladies' Walking Costume, new blue, tan, navy, brown, gray or black; nun's veiling or canvas cloth, lined throughout with taffeta silk, collar, yoke and belt of silk in contrasting color, finished with passementerie ornaments..... \$72.00
 Same, of etamine, in tan, new blue, navy or gray, lined throughout with silk 65.00
- No. 33.** Ready-Made Walking Costume, waist and sleeves tucked, silk collar and belt, soft front of tucked white mousseline de soie and lace; colors, navy blue, brown, royal blue or black serge..... 29.75
- No. 35.** Ready-Made Costume of Navy or Black Chevot Serge, vest of changeable taffeta silk, blouse lined with fancy silk..... 19.75
- No. 37.** Ready-Made Foulard Silk Costume, bands of lace over plain silk in contrasting color, front of accordion plaited black chiffon over colored silk; colorings, navy blue, green, brown, heliotrope or black and white 34.50
- No. 39.** Stylish Ready-Made Changeable Taffeta Silk Costume, skirt and sleeves trimmed with narrow black lace, velvet yoke and belt, finished at neck with Crepe de chine bow, all the newest colorings..... 38.50
- Style M. Made to order.** Black Fish Net Costume, made over black or colored taffeta silk, trimmed with rows of black satin ribbon, yoke of spangled net, neck and sleeves finished with ruche..... 90.00
 Same, of blue, green, navy, tan, heliotrope or black and white figured foulard silk, yoke of heavy cream lace..... 75.50
- For Costumes Made to Order, we will send samples of materials and trimmings upon application.

STERN BROTHERS'

SPRING AND SUMMER CATALOGUE, 1898.

NO.

92

When Ordering,
Mention Number
of this
Catalogue.

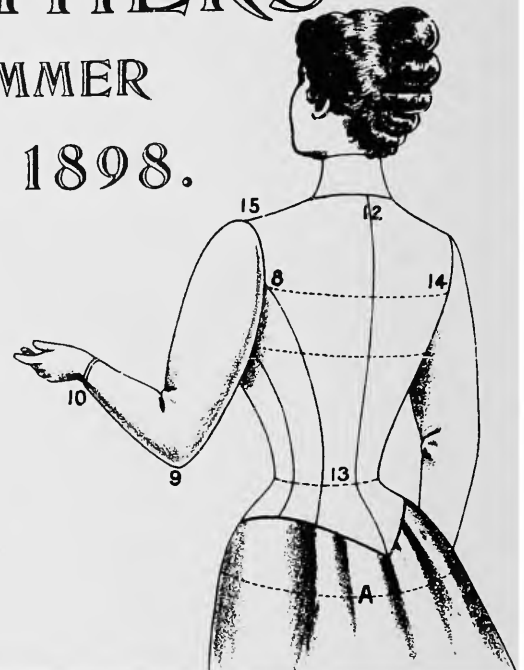
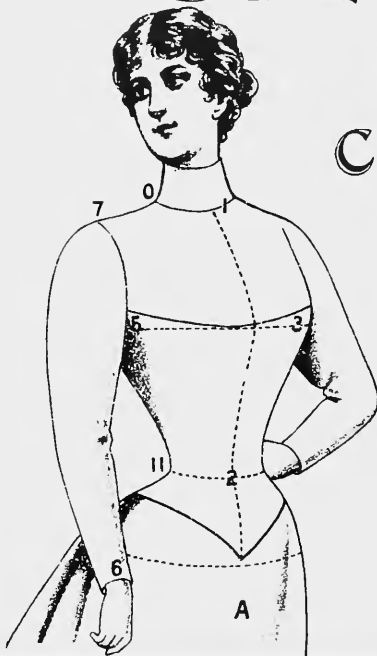

MEASUREMENTS AND DIRECTIONS FOR COSTUMES MADE TO ORDER ONLY.

FRONT.—1. Around the neck.
1 to 2, neck and waist.
3 to 5, bust, to be taken all around under arms.
5 to 6, length of sleeve inside.
Side of neck, 0 to 7, length of shoulder.
3 to 11, from under arm to waist.
11, size of waist all around.
A.—Around hips.

BACK.—12 to 13, length of back to waist.
8 to 14, across back.
15 to 9, shoulder to elbow.
9 to 10, elbow to wrist.

SKIRT.—Length in front from waist.
Length in back from waist.
Length at side from waist.

By following above measurements, we will insure a perfect fit. We would prefer, however, that our patrons will send a well-fitting waist as guide (thus doing away with any possibility of a misfit), which can be sent by mail at a trifling expense, *writing your name and address only on outside of package, to avoid letter postage, giving measures and all other explanations by letter (separate)*. See directions, page 109.

A DEPOSIT REQUIRED ON ALL GARMENTS MADE TO ORDER.

We will send, upon application, samples and estimates for Ladies' Costumes to order.

FIGURE 66b. Directions for taking measurements for made-to-order costumes such as styles L and M in Figure 66a.

and Christman, 1974:53). It was largely a matter of demand and priorities. Available almost everywhere were dressmakers proficient in dressing women in individual creations at very little cost. Women with even less money made their own dresses and saved their clothing dollars for the purchase of ready-made garments for the older males in their families. They spent their limited resources for the clothing that was the most difficult to make. Some tentative beginnings of ready-made for women came in the area of women's wraps as early as the 1830s (Kidwell and Christman, 1974:63). There was an existing need

for these articles. Sometimes they were made of heavy, hard-to-sew material and many did not require a close fit. By the last quarter of the 19th century ready-made wraps were a major industry.

FIGURE 67. Simple and looser fitting one-piece fashions, popular by the second decade of the 20th century, that made it possible for more women to buy clothes that fit "off the rack." Mass production achieved dramatically low prices: from left to right, these three frocks cost \$14.98, \$16.98, and \$7.98. From *Bellas Hess & Co. Catalogue*, Fall and Winter 1912-1913. (Warshaw Collection, Smithsonian Institution.)

DRESSES OF NEW AND CHARMING STYLE

SIZES.—Dresses can be furnished in two proportions, regular sizes 32 to 44 bust and skirt length 37 to 43 inches, also proportioned to fit misses or small women, sizes 32 to 38 bust and skirt length 37 to 40 inches. The skirts are finished with deep basted hem and can be easily altered by customer if necessary.

Samples of Velvet and Cloth dresses furnished on request. We do not send samples of chiffon dress 35K610.

35K610. A handsome gown of finest imported Chiffon, made over a foundation of lustrous Satin Messaline. This superb creation is beautifully embroidered as illustrated with fancy silk cord, combined with embroidery in contrasting color worked in silk and gold thread. The embroidered design also trims the back. Yoke and collar are of shadow lace, the yoke being outlined by satin piping and silk cord. The short sleeves are of chiffon prettily draped over messaline and trimmed with a strap of satin messaline ending in a chic little bow. Sleeves are edged with ruffle of Chantilly lace. The messaline underskirt is plain and the chiffon overskirt is gathered full at the waist line, especially so in the back, falling over the underskirt in pretty, graceful rippling folds. In the front the chiffon laps over as pictured and is caught at the hem with a large buckle effect of chiffon. Waist and skirt are joined by a crushed chiffon girdle, trimmed at right side with large buckle. There is also a buckle in the center of the back. Dress fastens invisibly in back. Comes in black, navy blue or gray chiffon over white messaline with contrasting color embroidery; also in black over black messaline with black embroidery.....\$14.98

35K611. A Charming Dressy Frock, made of fine quality Velvet. The material used in this dress is very attractive and the style is both new and becoming. Dress is designed on Directoire lines with a becoming Robespierre collar of satin messaline which may be worn in standing effect as pictured or may be turned down flat as shown in the small illustration. The becoming jabot in front is of Oriental lace trimmed with handsome pearl buttons and the Directoire revers and pointed cuffs are of fancy basketweave silk in contrasting color. Sleeves are piped at armholes with satin and the cuffs are finished with dainty Louis XVI frills of lace. The set-in vest in the front is of satin messaline trimmed with velvet buttons. Vest is continued down front of skirt as pictured. Waist and skirt are joined by a crushed girdle of satin messaline. Skirt in the back has two stitched plaits down entire length forming an inverted panel effect, while in front the stitched plaits admit a V-shaped insert of satin messaline at the bottom which is trimmed with velvet buttons. Dress fastens invisibly in the front. Body of waist is lined. Colors: black, navy blue or brown with revers, vest and cuffs of contrasting color.....\$16.98

35K612. A Neat and Stylish Dress, made of extra good quality ill-worsted Serge. Dress is designed in Russian Coat effect and has large Directoire revers and lovely pointed cuffs made of fancy striped velvet. Yoke and collar are of Oriental lace, collar being finished with satin piping. The panel effect in front is trimmed with buttons having velvet rims. Back of waist is plain. Skirt is made with a deep peplum effect giving the appearance of a coat, and the joining of waist and skirt is hidden beneath a patent leather set, which fastens with a handsome buckle. Below the coat effect, the skirt is plain, both back and front. Dress fastens invisibly in the front. Comes in black or navy blue with attractive harmonizing striped velvet trimming....\$7.98



35K610

Velvet
35K611

35K612
Serge

All types of underwear as well as nightclothes, wrappers, and sports clothes were also available and popular.

In the 1880s ready-made dresses were produced and offered to a wide ranging population through mail-order catalogs. But the manufacture of such dresses did not reach any level comparable to the production of other kinds of ready-made garments. Historians have advanced a number of theories (none of them adequate in my judgment) to account for this lag. My explanation for this slow development of the dress industry is the close fitting, intricate styles that were fashionable.

Upper body garments including wraps and underwear such as chemises and corset covers were sold satisfactorily simply by bust measurements. The patterns used to cut these garments were drafted with proportional systems. The extraordinarily close cut of women's dress bodices, however, could not be proportionally sized to fit many women. Lord & Taylor tried in 1881. Their catalog advised, however, "The bust measure and skirt length only are guaranteed, the other measures are in proportion; if other measures are necessary to insure a fit, the garment will need to be made to order" (1881:30). Apparently, Lord & Taylor and many other department stores found that with the fashions of the 1880s, only a limited percentage of women could wear dresses cut by proportionally sized patterns. It was not profitable to mass produce dresses sized this way.

Most ready-made dresses in the 1880s were cut from patterns drafted with a simple hybrid system which incorporated the waist measurement (Figure 65). In the fall and winter catalog of 1888-1889, B. Altman & Co. announced, "The dresses illustrated on this page are made in proportionate sizes and can only accept the following measurements: bust, waist and skirt length in front" (1888-1889:4). If

Altman's produced one style of dress in the five usual bust sizes (34 to 42) they would have had to make garments in a variety of waist dimensions for each bust size. If only a range of three waist measurements were cut there would have been 15 different sizes for one style of dress. On the other hand, the less fitted kinds of garments could be offered successfully in only five sizes. Ready-made dresses required a huge inventory and a major risk.

Even providing this extraordinary range of sizes cut by a hybrid system did not insure a good fit for many women. Professional dressmakers in the 1880s had already abandoned such simple hybrid systems. Advertisements for ready-made dresses reflected these difficulties. Special reminders were included pointing out that these garments were not made to order, but were manufactured in large quantities in order to offer them at attractive prices. The store could only "vouch for" the bust, waist, and front skirt length measurements. Given the fashion dictates of the day, a large proportion of the female population still needed custom cutting.

With the more draped waist styles of the late 1890s, ready-made dresses were successfully sold by the bust measurement and skirt length only. Proportional systems were used to cut the master patterns. Stern Brothers in 1898 could offer just five sizes for each style (Figure 66a). This was a manageable inventory that a number of women could wear because of the looser styles. The risk of producing these garments was reduced to an acceptable level and the mass production of ready-made dresses expanded. The manufacture of women's dresses finally achieved a major position in the clothing industry in the second decade of the 20th century when fashions called for one-piece loosely fitted dresses (Figure 67).

Conclusions

The creation of the first tailors' drafting systems in Europe was a technological revolution against the individualistic, secretive practices of the past. By systematizing the drafting process into specific, clearly defined steps, cutting was transformed from an intuitive art into a more easily learned craft. With the publication of drafting systems the

traditional code of secrecy was broken and the trade was opened to aspiring tailors. Drafting systems democratized this trade.

Dressmakers' drafting systems, however, were to have an even broader democratizing effect. The earliest I found was created in the United States before 1838 (Figure 16a). Significantly, this was an

American invention and not an imported European innovation. When the pre-Tentler system was being devised, an egalitarian spirit was building momentum in the United States. It challenged the aristocratic domination of American politics with the election of Andrew Jackson as president in 1828. This spirit created pressure for equality in all phases of life. The individual demanding political and economic rights equal to his "betters" also wanted to look equal. In my opinion this American, egalitarian movement encouraged the creation of the pre-Tentler system—an attempt to offer the woman, forced to make her own clothes, the technique for cutting a better fitting garment.

The sized paper pattern industry was also established first in the United States rather than in Europe. Unsized paper patterns were sold to professional dressmakers in England as early as the mid-1820s (Arnold, 1973:121). Thirty years later unsized paper patterns were sold in the United States (*Godey's*, Feb 1854:467). In the States, however, proportional systems with perforated tools were also available. By the 1860s these proportional systems were used to grade mass-produced, sized patterns. E. Butterick & Co. and Mme. Demorest's were prospering international businesses by 1876, supplying women in the United States and Europe with the patterns for their home-made fashions. In 1919, fifteen companies in New York City produced patterns worth almost a million and a half dollars (U.S. Census, 1923, 9:1065).

Dressmakers' proportional drafting systems with the resulting sized pattern industry helped to place better fitting, more fashionable attire within reach of amateur dressmakers who had to make their own clothes.

The old saying "Necessity is the mother of invention" is well illustrated by drafting systems created for professional dressmakers. In the mid-1870s fashion dictated that the upper part of a woman's body be encased by a closely fitting basque. Although fashion exhibited some change in the 1880s, the basque continued to be a complexly cut challenge to the most experienced dressmaker's skill. Inventors responded to their need by creating more drafting systems.

In the Library of Congress collection of dressmakers' instruction books there are three from the 1860s, 22 from the 1870s, and 106 from the 1880s (Figure 68). The numbers of patents

granted for drafting systems also reflect the inventive responses to the crisis caused by fashion. From the 1820s through the 1870s more patents were issued for techniques related to cutting men's garments than for women's apparel. But the number of patents granted for cutting women's attire jumped from 20 in the 70s to 59 in the 1880s—almost twice as many as were granted for men's garments (Figure 69).

The relationship between need and creative activity is not as clearly documented for the 1890s and 1900s. The Library of Congress holdings decrease from 106 for the 1880s to 57 for the 1890s, to 22 for the first decade of the 1900s (Figure 68). On the other hand, the number of patents granted for women's garments increased from 59 in the 1880s to 70 in the 1890s and only decreased by four in the early 1900s (Figure 69).

Since the Library of Congress collection is but a sampling of all the instruction booklets that were printed, there is the possibility that this collection is not totally representative of the systems that were produced. On the other hand, the data from the U.S. Patent Office are a complete record of the state of the art represented by patents. Thus it could be argued that the number of patents issued in each decade is a truer reflection of the use of dressmakers' drafting systems than the Library of Congress collection. I do not agree. The patent data are a complete record, but of what? They represent the creative activity of individuals who chose to obtain a patent. This activity, spread across the country (Appendix IV), reveals that the need for drafting systems was a general concern and not just limited to the four major cities—Boston, Chicago, New York, and Philadelphia.

The patents are not, however, a true representation of the systems which were produced and used. Anyone could obtain a patent if he could prove his claims were unique. He did not need to prove that his invention was useful or commercially practical. Many patented innovations were never produced or, if they were manufactured, they were not financially successful (Figures 45 and 46). It is not possible to determine how many of the patented claims were actually used in the dressmaking trade.

The number of patents granted in the 1890s and 1900s may be inflated in part by the length of time required to obtain a patent. After developing what he thought was a new invention, an individual

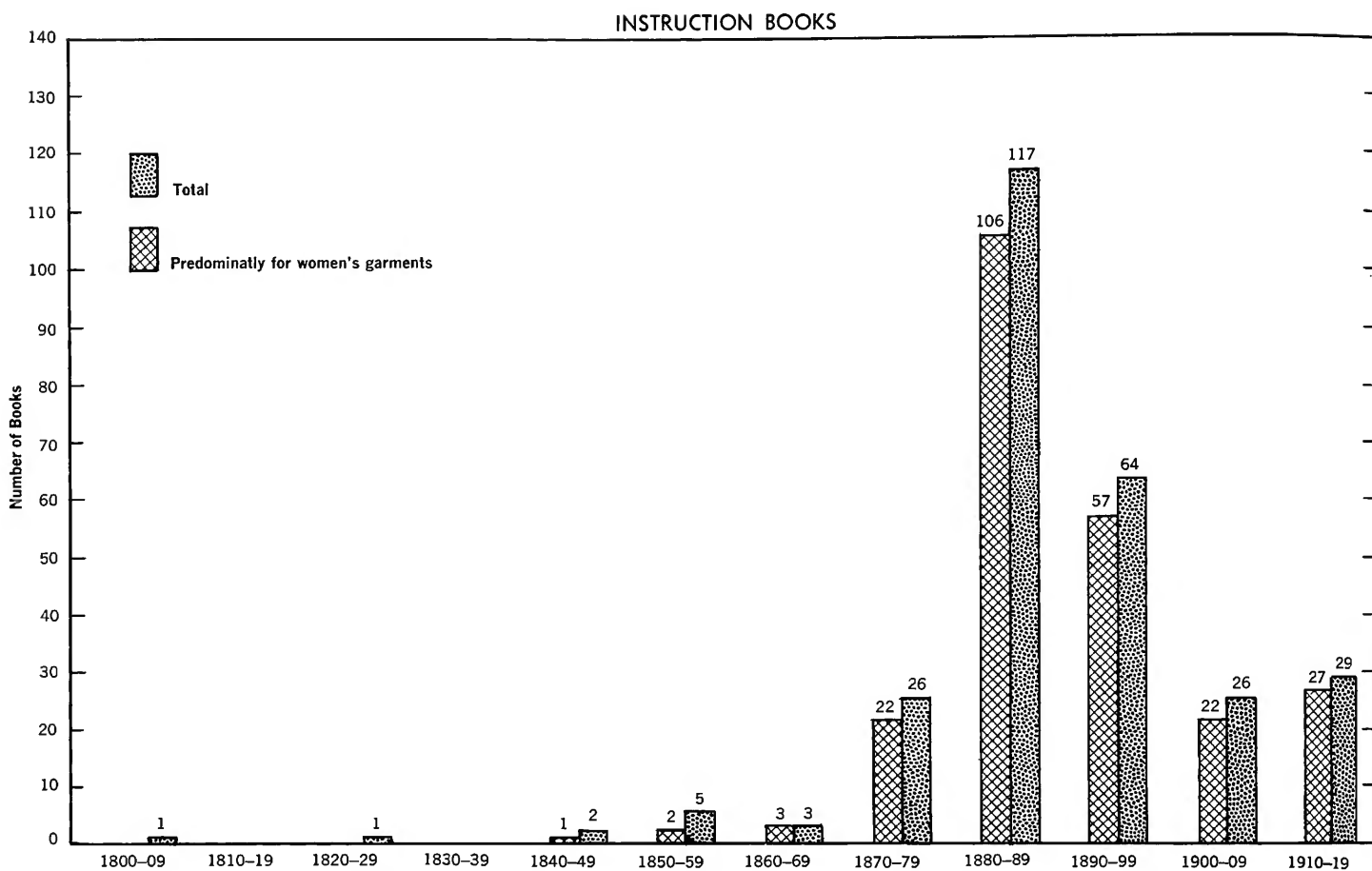

FIGURE 68. Number of Library of Congress instruction books (excluding periodicals) published each decade, from Appendix I.

consulted a patent attorney. The application and drawings had to be drawn up to conform with the requirements of the U.S. Patent Office. If they were not, his application would be sent back. If the form of the inventor's application was in order it was exposed to the scrutiny of a patent examiner. This specialist was charged with the responsibility of determining that the claims were truly unique. The Patent Office correspondence files reveal frequent lengthy correspondence between examiners and the inventors' attorneys as claims were denied, modified, resubmitted, and denied again. This process took time. Albert McDowell filed an application on 11 December 1883 but he was not given his Letters Patent until 6 January 1885 (U.S. Patent 310,297). The style of garment cut by the tool

illustrated in the patent drawing (Figure 41) was no longer fashionable. Many otherwise practical inventions may have also been made obsolete by changing fashions by the time the patent was granted.

A number of patents granted for drafting systems in the 1890s, 1900s, and 1910s were intended to be used for drafting and grading patterns for ready-made clothing. Unfortunately, the inventions intended for this growing industry cannot be separated with any certainty from those designed for the custom trade. The patent data include many inventions that were not produced or that were created specifically for cutters of ready-made clothing. Since it is not possible to separate these patents from those useful to cutters of custom-made garments the pat-

PATENTS

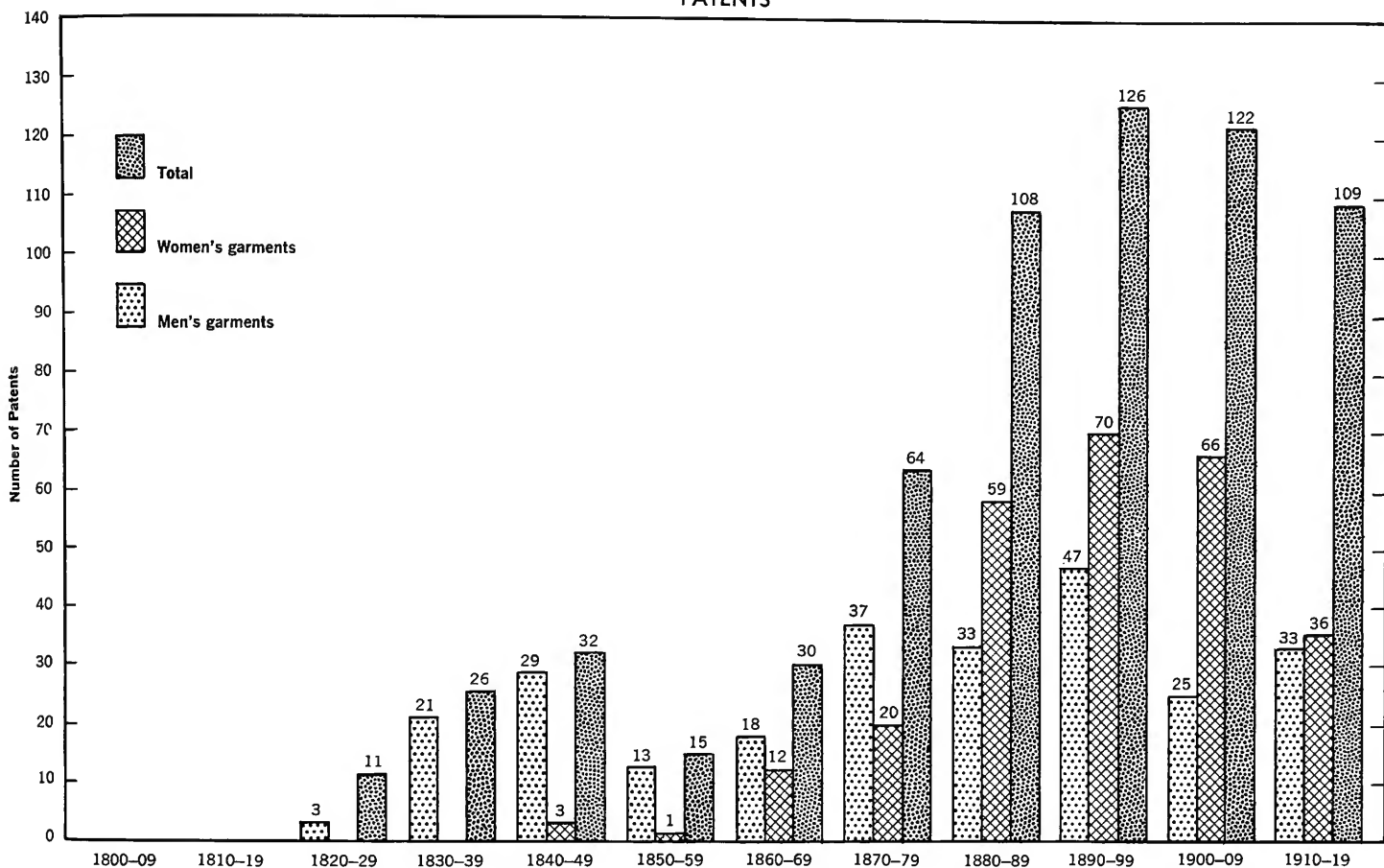

FIGURE 69. Number of U.S. Patents related to drafting systems granted each decade, from Appendix III.

ent data are not a reliable indication of the use of dressmakers' drafting systems.

The instruction books in the Library of Congress, however, were all printed for systems that were offered for sale. Some were not commercially successful, others, like the McDowell machine, were used widely. The number of books accessioned by the Library does not, however, reflect the relative popularity of these systems. There are also some obvious gaps in this collection. For example, there are four McDowell instruction books in the Library dating from the 1880s, but none from the 1890s. Nevertheless, of the eight extant McDowell systems brought to my attention, all have instruction books copyrighted in the early 1890s.

Thus with only the heterogeneous patent data and the incomplete Library of Congress holdings to work from, many of my conclusions are speculations. Certainly the complexly cut fashions, coupled with the growing middle class demand for fashionable clothing, created a necessity for accurate drafting systems in the last half of the 1870s. To meet this continuing need many more systems were offered for sale in the 1880s than were produced ten years earlier. I speculate that the number of dressmakers using drafting systems in the 1890s remained almost as high as in the 1880s. The number of different systems that were used, however, declined. I suspect that after ten years of trying a wide variety of hybrid and direct-measure systems, dressmakers settled on those few that

TABLE 1.—Numbers of women's clothing factory establishments and the value of their products in four cities, arranged by decade (developed from U.S. Bureau of Census reports: 1883; 1895; 1902, volume 8; 1913, volume 10; 1923, volume 8)

Year of census	Boston		Chicago		New York		Philadelphia	
	Number of establishments	Value of products (\$)	Number of establishments	Value of products (\$)	Number of establishments	Value of products (\$)	Number of establishments	Value of products (\$)
1879	24	1,808,520	19	1,585,990	255	19,641,802	49	2,466,410
1889	35	1,506,212	71	6,422,431	777	43,815,553	74	3,335,746
1899	88	3,258,483	151	9,208,454	1,604	102,697,854	191	9,452,259
1909	139	8,748,500	204	15,676,925	3,058	270,646,086	355	30,193,475
1919	173	20,655,935	374	64,203,000	5,089	866,243,561	537	69,183,831

were most effective.

I believe that by 1900 dressmakers' drafting systems had begun a rapid decline in importance. The changing fashions, the growing ready-made clothing industry, and the increasingly cheaper and more widely available paper patterns contributed to the conversion of the dressmakers' drafting tool from a vital piece of equipment to an obsolete artifact of the past.

In the late 1890s fashionable dress became a more loosely fitted garment. This trend continued with the widespread use of the one-piece dress by 1910. With easier fitting fashions the ready-made clothing industry could successfully sell dresses and suits and shirtwaists to more women. This success encouraged the rapid increase in the number of manufacturing establishments. This re-

markable growth is verified by census statistics gathered in four major cities—Boston, Chicago, New York, and Philadelphia (Table 1). The development of the women's clothing industry becomes even more dramatic when viewed in relation to the men's wear industry (Table 2). In 1879 almost 11 times the number of establishments were producing men's apparel as were manufacturing women's garb. In each succeeding decade, however, the relative size of these two industries changed. By 1919 the women's clothing industry exceeded the men's industry both as to the number of establishments and the value of products.

Unfortunately no comparable census statistics exist to document continuously the decline of the custom trade in relation to the growth of the ready-made industry from 1879 to 1919. Some

TABLE 2.—Comparative growth rate of the industries for men's and women's factory-made clothing, measured by number of establishments and value of products, arranged by decade (developed from U.S. Bureau of Census reports: 1883; 1895; 1902, volume 8; 1913, volume 8; 1923, volume 8)

Year of census	Men's clothing		Women's clothing	
	Number of establishments	Value of products (\$)	Number of establishments	Value of products (\$)
1879 (based on 100 cities)	6,166	209,548,460	562	32,004,794
1889 (based on 165 cities)	4,867	251,019,609	1,224	68,164,019
1899 (based on 209 cities)	5,729	276,717,357	2,701	159,339,539
1909	5,584	485,677,493	4,558	384,751,649
1919	5,258	1,162,985,633	7,711	1,208,543,128

scattered evidence does exist, however, to suggest the trend of events. The 10th Census, conducted in 1879, excluded the gathering of data concerning all custom work. Nevertheless, the disparity between the well established ready-made men's wear industry and the small women's industry provoked the following observation in the final census report: "It is significant of the habits of people that while the production of men's clothing in distinct establishments is reported in 43 states and territories, that of women's clothing is reported for only 25, domestic manufacture or custom dressmaking taking the place of the shop or factory in supplying the demand in 22 states or territories" (U.S. Census, 1883:xviii).

The 11th and 12th Censuses (conducted in 1889 and 1899) did consider custom work as well as factory production. In 1889 there were 16 times as many dressmaking establishments as there were manufacturers of ready-made clothing. The value of the custom-made products, however, was 84% of the value of ready-made garb (U.S. Census, 1902, 9:302). Apparently even the hard to fit ready-made dresses of 1889 were being bought by women who could not afford custom-made dresses but who, for a variety of reasons, chose not to make their own clothes. One of the reasons for this change may have been the growing number of employed women who had need for attractive, durable clothing but who had little time to make it themselves.

By 1899, the number of dressmaking establishments had dropped while the number of factories had increased. There were only five times as many dressmaking establishments as manufacturers of ready-made garb. And the value of custom-made costume had dropped to only 30% of the value of ready-made clothing (U.S. Census, 1902, 9:302). In 1899, the looser, fashionable styles increased the probability of finding a ready-made garment that fit. Thus even women who could occasionally afford dressmaker-made costumes were more often choosing to buy less expensive ready-mades (Figure 66 *a*). Census statistics show that in the last year of the 19th century the margin by which women's ready-made clothing exceeded custom-made was greater than at any previous time. The importance of the professional dressmaker was most certainly declining.

Before going further with this line of reasoning it is necessary to take a second look at the census

statistics. No data were gathered in 1889 or 1899 on dressmakers earning less than \$500.00 a year. This excluded group would include a majority of the small town dressmakers, particularly those who received bed and board as part of their payment. Thus I must modify my previous statements. The dressmaker rapidly declined in importance in urban centers where rack after rack of ready-made clothing appeared in specialty and department stores. In small towns and villages, however, the significance of the local dressmaker probably decreased each year but at a slower rate than among her urban sisters. The net result was the same. Dressmakers became less important.

The significance of the dressmaker's role declined even faster in the 20th century. The fashions of the first two decades of the 1900s, even less fitted than those near the end of the previous century, made it possible for "respectable" middle class women to buy the cheaper ready-made garments for every-day use.

Dressmakers' drafting systems, however, diminished in importance at an even faster rate than did the custom trade itself. The simpler fashions of the 20th century required fewer and less complicated pattern pieces. Sized paper patterns could be mass produced at a lower cost with the savings passed on to the client. Fewer alterations were required to make the commercial pattern fit a particular woman.

A pattern for the radically new, one-piece dress fashions of the 1910s (Figure 67) could not be drafted, in one step, with a specialized tool for a system produced only ten years earlier. A fashionable pattern could be developed from the draft made with an obsolete tool, but the dressmaker had to know how to proceed with this extra step. Since the purpose for using a drafting system with a specialized tool was to be able to cut a pattern in the most direct way with a minimum of "figuring," it seems likely that the majority of dressmakers dependent on these tools discarded them in favor of paper patterns. Dressmakers who used systems requiring only a tape measure and a square could have continued their trade without resorting to paper patterns.

The first generation of drafting systems was created, in the first half of the 19th century, to appeal to the market composed of women on the lower rungs of the socio-economic ladder who sought a chance to uplift their appearance. The

inventors of these systems succeeded beyond their wildest expectations. The first fruit that their efforts bore was the uniquely American version of the craft of dressmaking. In addition, their ideas were used as the basis of the sizing systems in the paper pattern industry and the women's ready-made clothing industry. Ironically, these industries grew, until, in the 20th century, their employees were the only individuals drafting women's garments with specialized tools.

The creation of 19th century dressmakers' drafting systems was part of a sociological and technological revolution against the exclusive, individualistic practices of the past, in this case, in the area of fashion. Although the American dressmaker's craft, which flourished in the 19th century largely because of such technological developments, has long since waned, the other two fruits of that revolution have persisted with contemporary economic and social significance.

Appendix I

Pre-1920 Publications at Library of Congress Containing Drafting Systems for Women's Garments

Pre-1920 publications containing any directions for drafting women's garments are included in this listing. Texts written for tailors have been added if they contained instructions for cutting women's garments, such as riding habits. Periodicals that regularly described drafting systems are incorporated as well as instruction books for specific systems. The dates given for periodicals designate the issues, published before 1920, which are in the possession of the Library of Congress. The dates do not necessarily indicate the complete run of a magazine. Titles that are repeated (in the same or different years) represent publications that are significantly different.

Asterisks designate the few publications that have not been examined. Bibliographic information for these unlocated volumes has been taken from the Library of Congress shelf list.

The "state of origin" reflects the author's residence if it is known to differ from the place of printing (publishing). (Most were privately printed in the author's home town.) Where the printing press was located is of less importance to this study than where the system was developed and used.

A drafting system that required a specialized tool is more easily understood if the device is at hand. If it is not available, an illustration of the tool is helpful. The fact that the drafting tool was "included" in the publication or that it was "illustrated" is indicated in the column under the heading "Drafting tool." The absence of any remark in

this column, however, does not necessarily mean that the systems described required no specialized device.

Each citation is annotated with abbreviations for men's, women's, or children's garments (M, W, C) to indicate the relative coverage of these kinds of apparel in each publication. Lowercase letters indicate that the discussion of the specified kind of apparel was of minor importance.

The number of any U.S. Patent granted to an individual associated with a publication is also listed. The patentee was the author unless an annotation specifies otherwise. No attempt has been made to verify that the patented claim was incorporated into the system described in the publication. The only assured connection between a publication and a patent is the name of the individual associated with both.

This listing of Library of Congress acquisitions should be used with discretion. Since the Library's holdings on the subject are the largest in the country, the techniques discovered from this source should give a good survey of the dressmaking practices in the United States before 1920. There are, however, copyrighted publications that have not been catalogued by this library. And there are undoubtedly many which have neither been copyrighted nor acquired by this institution. A nation-wide search is needed to assemble a truly comprehensive listing of extant materials.

<i>Publication</i>	<i>State of origin</i>	<i>Drafting tool</i>	<i>Clothing type</i>	<i>U.S. Patent</i>
Abercrombie, Emma 1889. <i>Garment Cutting Self-Taught, A Book Containing Instructions and Diagrams, Showing How to Use the Abercrombie Scale</i> Coal Centre, Washington Co.: Privately printed.	Pennsylvania		m W C	
<i>The American Fashion Review</i> . See <i>The Sartorial Art Journal</i> .				

<i>Publication</i>	<i>State of origin</i>	<i>Drafting tool</i>	<i>Clothing type</i>	<i>U.S. Patent</i>
<i>The American Ladies' Tailor</i> (1903–1919). New York: The Jno. J. Mitchell Co. [Published monthly except May and November. The tool was included in the issues for January and February, 1903.]	New York	included	W	
<i>The American Modiste: Published in Connection with the American Garment Cutter</i> (Jan 1903, 1904–1913). Chicago: Jonathan Nelson & Co. [Published quarterly. Patent issued to Jonathan Nelson.]	Illinois		W	717,253
Barnes, A. L. 1892. <i>Dress Fitting Made Easy</i> . Philadelphia: Privately printed.	Pennsylvania		W	
Baughman, Mr. and Mrs. J. S. 1892. <i>Baughman's Advanced Hints on Dress Cutting</i> Burlington: Privately printed.	Iowa		W	422,282 430,059 675,537
Bayne, J. Reid 1883. <i>Bayne's Self-Instruction Book for Dress Cutting by the French Glove-Fitting Tailor System, by Exact Measure: A Manual for the Use of Bayne's Paris Scale</i> . New York: Privately printed.	New York	illustrated	W	
Bearrie, A. E., & Co. 1890. <i>... The Perfect Dress Fitter ... Complete Instructions in the Art of Cutting All Kinds of Garments</i> . St. Louis: A. E. Bearrie & Co.	Missouri		m W C	
Bell, Mattie M. 1893. <i>... Cutting and Fitting Made Simple and Easy</i> . Troy: Privately printed.	Alabama		W	
Bennett, Ella Alvira 1914. <i>The Perfect Dressmaking System</i> . Des Moines: Privately printed.	Iowa		W C	1,183,845
Berkowich, Louis I., editor 1904? <i>A Complete Grading Manual of All Kinds of Garments Worn by Ladies' [sic], Misses' [sic] and Children</i> . New York: Berkowich Designing Academy.	New York		W C	
Bisbee, F. S. 1895. <i>Instruction Book of Bisbee's American Tailor System of Dress Cutting</i> . Boston: American System Co.	Massachusetts	illustrated	W	
Blackburn, Juditha 1917. <i>The Textbook for the Use and Application of the Blackburn Adjustable Drafting Device</i> . Los Angeles: The Blackburn Company.	California	illustrated	W	985,971 1,276,316
Blair, Margaret J. 1897. <i>Margaret Blair System of Garment Drafting, Used in School for Girls, Agriculture Department of State University of Minnesota, and James Industrial Training Institute, Minneapolis, Minn. ...</i> Minneapolis: H. L. Collins Co. 1904. <i>Margaret J. Blair's System of Sewing and Garment Drafting</i> . 3rd edition revised. St. Paul: Webb Publishing Co.	Minnesota		W C	
Blakely, Elizabeth, and Frances Patton 1907. <i>The Practical System for Drafting Ladies' and Children's Clothing, Designed for Use in the Public Schools</i> . 2 volumes. New York: Hinds, Noble & Eldredge.	New York		W C	
Blaney. See Carman & Blaney.				
Briggs, D. B. 1889. <i>Directions for Using the New York Self-Instructing System and Chart for Cutting Ladies' and Misses' Dresses, Basques, and Other Garments</i> . Albany: The Briggs Chart Company.	New York	illustrated	W	

	Publication	State of origin	Drafting tool	Clothing type	U.S. Patent
Brown, Harriet A[delaid]					
1902.	<i>Scientific Dress Cutting and Making: "The Harriet A. Brown System" Simplified and Improved.</i> Boston: Privately printed.	Massachusetts		W C	
Buddington, Mr. and Mrs. F. E.					
1887.	<i>Supplement Studies for Those Using the Buddington Dress Cutting Machine.</i> Chicago: Privately printed.	Illinois		W C	272,204 440,692 541,311 618,392
1896.	<i>Instruction Book for Using the Buddington Improved Dress Cutting Machine with Dart Attachment for Cutting French Bias Basque, Enlarging Darts, etc.</i> 1st edition. Chicago: Privately printed.	Illinois	illustrated	W	272,204 440,692 541,311 618,392
Byrnes, T[homas] W.					
1882.	<i>T. W. Byrnes' New and Improved System, with the Dress-Maker's Model Measure Sheet.</i> Manitowoc: Privately printed.	Wisconsin		W	282,842
Carlstrom, Jno. A.					
1905.	<i>Carlstrom's Proportions of the Human Form: A Scientific Treatise on Proportions as They Apply to Garment Construction.</i> New York: The Jno. J. Mitchell Co.	New York		M w c	918,279
Carman & Blaney					
1884.	<i>The American Metrical System for Cutting Ladies' and Children's Dresses and All Close Fitting Garments with a Table of Calculations for All Sizes</i> Steubenville: Privately printed.	Ohio	illustrated	W	
Clavé, Justin					
1859.	<i>To the Ladies: New Geometrical Method; or, Easy and Infallible Manner of Taking the Measure, Drafting and Cutting Dresses of Ladies . . . According to a System of Proportions Adapted to the Human Body.</i> Philadelphia: Privately printed. [This single sheet of paper is a perforated tool for a proportional system.]	Pennsylvania	included	W	
Clute, J. Redfield					
1891.	<i>Clute's Actual Measurement System and Key to Scientific Dress Making.</i> Minneapolis: Privately printed.	Minnesota		W	
Coleman, M[ary] V[irginia]					
1887.	<i>The Science of Gynametry.</i> Atlanta: Byrd & Pattillo.	Georgia	illustrated	m W C	357,762
Cornwell, Willett					
1883.	<i>Cornwell's Improved Self-Fitting System for Dress Cutting: Instruction Sheet.</i> Chicago: Privately printed.	Illinois	partially illustrated	W C	209,111
1885.	<i>Cornwell's New Improved Self-Fitting Chart and Sleeve System for Cutting Ladies', Misses', and Children's Dresses, Cloaks, Basques, and Postillions.</i> Chicago: Privately printed.	Illinois	illustrated	W C	209,111
1888.	<i>Cornwell's New Instruction Book, for Learning Their New Improved Self-Fitting Chart and Sleeve System for Cutting Ladies', Misses', and Children's Dresses, Cloaks, Basques, Dolmans, Postillions, and Many Other Useful Garments.</i> Chicago: Privately printed.	Illinois		W C	209,111
Custom Cutter (1890–1897). Chicago: The Robert Phillips Co. [A monthly publication which occasionally showed drafting systems for women's garments.]		Illinois		M w	
Davis, Myra A.					
1888.	<i>Directions for Cutting Garments with the Davis Improved Square.</i> Portland: Privately printed.	Maine	illustrated	W	365,800
Davis, Mrs. M. E.					
1882.	<i>Mrs. M. E. Davis' Dress Chart and Self-Instructor.</i> St. Joseph: Privately printed.	Missouri		W C	

	<i>Publication</i>	<i>State of origin</i>	<i>Drafting tool</i>	<i>Clothing type</i>	<i>U.S. Patent</i>
deLamorton, O. H.					
1892.	<i>Prof. O. H. deLamorton's Self-Teaching Instruction Book for the Parisian Champion Scientific Tailor System.</i> New York: Privately printed. [Published bi-monthly.]	New York		W C	
Denieffe, Joseph					
1900.	<i>The Geometric: A System of Cutting Garments for Ladies and Gentlemen on Geometrical Lines and Principles.</i> Chicago: Privately printed.	Illinois		M w	
Denny, Mrs. L.					
1891.	<i>The Perfection Taylor System by Actual Measurement for Ladies' and Children's Garments.</i> David City: Privately printed.	Nebraska		W	
Devereaux, C. A.					
1883.	<i>Devereaux's Actual Measure System, The Science and Geometry of Dress.</i> St. Paul: Privately printed.	Minnesota	illustrated	W	
Diamond Garment Cutter Correspondence School					
1903.	<i>Instruction Book.</i> Volume 1. Chicago: Diamond Garment Cutter Co.	Illinois		W C	
1905.	<i>Supplement to the Diamond Garment Cutter Instruction Book.</i> Volume 2. Chicago: Diamond Garment Cutter Co.	Illinois		W C	
Dilday, E.					
1856.	<i>E. Dilday's Plain and Concise Method of Garment Cutting so as to Fit All Possible Forms of Persons, with Directions for Putting the Work Together, Ready for Sewing.</i> St. Louis: Privately printed.	Missouri		M w	
Dittmar & Sheifer					
1888.	<i>The Self-Balancing System, or The Cutters' Guide.</i> New York: Dittmar & Sheifer.	New York		M w c	
1891.	<i>The Self-Balancing System of Cutting Ladies' Garments', by Dittmar & Sheifer, Including Scales of the Self-Balancing System for Cutting.</i> New York: Dittmar & Sheifer.	New York	included	W	
Doolittle, Oliver Taylor					
1901.	<i>Straight Shoulder Rules, Systems and Methods of the Present Day: Women's Garment Cutting.</i> Philadelphia: Oliver T. Doolittle.	Pennsylvania	illustrated	W	
Doran. See Goldsberry & Doran.					
Doughty & Co.					
1887.	<i>Doughty's New Work on Dressmaking, by the New Improved and Perfect Tailor System, of Square Measurement.</i> Cincinnati: Doughty & Co.	Ohio		M W C	
Ēggleston, Lillian A. See Frank O. Tappan.					
Elliss, Amelia B.					
1883.	<i>The "London Tailor" System of French Cutting, for Cutting Ladies' and Children's Garments, Dresses, Cloaks, Coats, Wraps, Mantles, and Riding Habits, Part First: Dresscutting and Dressmaking.</i> Philadelphia: Privately printed.	Pennsylvania		W C	
Elmes, B. S.					
1888.	<i>Instructions and Diagrams for Using the New Complete Tailor System of Dress Cutting.</i> New Edition. Springfield: Privately printed.	Massachusetts		W	
Engelmann, Gustav					
1904.	<i>The American Garment Cutter for Women.</i> New York: American Fashion Company.	New York		W C	
1913.	<i>The American Garment Cutter for Women's Garments.</i> 2nd edition. New York: American Fashion Company.	New York		W C	

	<i>Publication</i>	<i>State of origin</i>	<i>Drafting tool</i>	<i>Clothing type</i>	<i>U.S. Patent</i>
Evan, H. P., Co.					
1896.	<i>Instruction Book for the Standard Tailor System: A Self-Instructor with Object Lessons in the Art of Cutting all Styles of Garments, for Ladies, Gentlemen, Children, and Infants.</i> Chicago: H. P. Evan Co.	Illinois		m W C	628,083
Ewing, Sarah C.					
1869.	<i>The Tailor System: Dress Cutting Made Perfect by Mrs. Ewing's Delineation of Scales, the Tailor System Simplified, the Knowledge of Which Was Gained by Mrs. S. C. Ewing, after Fifteen Years' Practical Cutting from the Same</i> Indianapolis: Privately printed.	Indiana		W C	112,024
1871.	<i>The Tailor System: Dress-Cutting Made Perfect by Mrs. Ewing's Delineation of Scales, the Tailor System Simplified, the Knowledge of Which Was Gained by Mrs. S. C. Ewing, after Fifteen Years' Practical Cutting from the Same</i> Indianapolis: Privately printed.	Indiana		W C	112,024
1888.	<i>The Tailor System: Dress-Cutting Made Perfect by Mrs. Ewing's Delineation of Scales, the Tailor System Simplified, the Knowledge of Which Was Gained by Mrs. S. C. Ewing, after Twenty Years' Practical Cutting from the Same</i> Indianapolis: Privately printed.	Indiana		W C	112,024
	<i>The Fashionable Woman's Tailor</i> (1912–1918). New York: Newman Fashion Company. [Published monthly.]	New York		W	
Ferguson, Albert Edwin					
1915.	<i>The New Era Pattern Cutting System: Ten Complete Lessons for Cut-To-Measure Foundation Patterns, Embracing a Thoro [sic] and Accurate System of Measuring.</i> Atlanta: The Blosser Company.	Georgia		W	
Flenner, Lewis. See Kromer & Flenner.					
Fitch, Morris					
1883.	<i>M. Fitch's Square, True, Tailor System, for Cutting Ladies' and Children's Garments</i> Chicago: Privately printed.	Illinois		W C	
Fountain, J. H.					
1883.	<i>Instructions for Using Fountain's Tailor System of Dress Cutting, Which Makes a Perfect Fit for Ladies and Children without Alteration.</i> St. Louis: J. H. Fountain & Co.	Missouri		W C	
1883.	<i>Instructions for Using Fountain's Tailor System of Dress Cutting, Which Makes a Perfect Fit for Ladies and Children without Alteration.</i> 2nd edition. St. Louis: J. H. Fountain & Co..	Missouri		W C	
1883.	<i>Instructions for Using Fountain's Tailor System of Dress Cutting, Which Makes a Perfect Fit for Ladies and Children without Alteration.</i> 3rd edition. St. Louis: J. H. Fountain & Co.	Missouri		W C	
1890.	<i>Instructions for Using Fountain's Tailor System of Dress Cutting, Which Makes a Perfect Fit for Ladies and Children without Alteration.</i> 5th edition. St. Louis: J. H. Fountain & Co.	Missouri		W C	
Fourier, P. A.					
1895.	<i>The Parisian Tailor Complete Instructor and Practical Guide to Ladies' Tailoring.</i> Philadelphia: Privately printed.	Pennsylvania		W	
	<i>The French Dressmaker, Formerly La Couturière</i> (1894–1895). New York: A. McDowell & Co. [Published monthly. Patents issued to Albert McDowell.]	New York	illustrated	W	213,436 310,297 342,216
Ganzhorn, William					
1885.	<i>A Geometrical System Revised and Enlarged, for Measuring, Draughting, and Cutting Dresses, Cloaks, Perelines,</i>	Massachusetts		W	263,779

	<i>Publication</i>	<i>State of origin</i>	<i>Drafting tool</i>	<i>Clothing type</i>	<i>U.S. Patent</i>
	<i>Wraps, Dolmans, Pelisses, Shoulder Capes, and Riding Habits, &c.</i> Boston: Privately printed.				
Gartland, Elizabeth					
1884.	<i>The American Lady-Tailor Glove-Fitting System of Dress-Making, from Experience and Practice.</i> Philadelphia: Privately printed.	Pennsylvania		W C	355,160
1884.	<i>The Original American Lady Tailor System.</i> Philadelphia: Privately printed.	Pennsylvania	illustrated	W	355,160
Gingles, Mae Milbourne					
1907.	<i>Garment Drafting by Simple Rule Method: A Student's Manual for Home and School Garment Cutting.</i> Saginaw: Seemann & Peters.	Michigan		W	
Glickstein, Philip					
1909.	<i>Glickstein's System: Ladies', Misses', and Children's Garments, Practical Methods of Designing According to Proportions.</i> New York: Privately printed.	New York		W C	
*1909.	<i>Glickstein's System of Designing and Cutting for Men's, Boys', and Children's Garments and Novelties.</i> New York: Privately printed.	New York		M C	
Goldsberry & Doran.	<i>See</i> W. H. Goldsberry.				
Goldsberry, Doran & Nelson.	<i>See</i> W. H. Goldsberry				
Goldsberry, W. H.					
1884.	<i>The National Garment Cutter.</i> Chicago: Goldsberry, Doran & Nelson.	Illinois	illustrated	m W C	247,339
1885.	<i>The National Garment Cutter.</i> Chicago: Goldsberry, Doran & Nelson.	Illinois	illustrated	m W C	247,339
1886.	<i>The National Garment Cutter.</i> Chicago: Goldsberry, Doran & Nelson.	Illinois	illustrated	m W C	247,339
1887.	<i>The National Garment Cutter Instruction Book.</i> Chicago: Goldsberry, Doran & Nelson.	Illinois	illustrated	m W C	247,339
1887.	<i>The National Garment Cutter Instruction Book.</i> Chicago: Goldsberry, Doran & Nelson.	Illinois	illustrated	m W C	247,339
1888.	<i>The National Garment Cutter Book of Diagrams.</i> Chicago: Goldsberry, Doran & Nelson.	Illinois		m W C	247,339
1888.	<i>The National Garment Cutter Instruction Book.</i> Chicago: Goldsberry, Doran & Nelson.	Illinois		m W C	247,399
1889.	<i>The National Garment Cutter Book of Diagrams.</i> Chicago: Goldsberry, Doran & Nelson.	Illinois		m W C	247,399
1889.	<i>The National Garment Cutter Book of Diagrams.</i> Chicago: Goldsberry, Doran & Nelson.	Illinois		m W C	247,399
1890.	<i>The National Garment Cutter Book of Diagrams.</i> Chicago: Goldsberry, Doran & Nelson.	Illinois		m W C	247,399
1890.	<i>The National Garment Cutter Instruction Book.</i> Chicago: Goldsberry, Doran & Nelson.	Illinois		m W C	247,399
1891.	<i>The National Garment Cutter Book of Diagrams.</i> Chicago: Goldsberry, Doran & Nelson.	Illinois		m W C	247,399
1891.	<i>The National Garment Cutter Instruction Book.</i> Chicago: Goldsberry, Doran & Nelson.	Illinois		m W C	247,399
1892.	<i>The National Garment Cutter Book of Diagrams.</i> Chicago: Goldsberry & Doran.	Illinois		m W C	247,399
1893.	<i>The National Garment Cutter Book of Diagrams.</i> Chicago: Goldsberry & Doran.	Illinois		m W C	247,399
1895.	<i>The Diamond Garment Cutter Book of Diagrams.</i> Chicago: Goldsberry & Doran.	Illinois		m W C	247,399
1895.	<i>The Diamond Garment Cutter Instruction Book.</i> Chicago: Goldsberry & Doran.	Illinois		m W C	247,399
1895.	<i>The National Garment Cutter Book of Diagrams.</i> Chicago: Goldsberry & Doran.	Illinois		m W C	247,399

	<i>Publication</i>	<i>State of origin</i>	<i>Drafting tool</i>	<i>Clothing type</i>	<i>U.S. Patent</i>
1895.	<i>The National Garment Cutter Instruction Book.</i> Chicago: Goldsberry & Doran.	Illinois		m W c	247,399
1896.	<i>The Diamond Garment Cutter Book of Diagrams.</i> Chicago: W. H. Goldsberry.	Illinois		m W c	247,399
1896.	<i>The Diamond Garment Cutter Instruction Book.</i> Chicago: W. H. Goldsberry.	Illinois		m W C	247,399
1897.	<i>The Diamond Garment Cutter Instruction Book.</i> Chicago: W. H. Goldsberry. [For clarity, the series of books above has been credited to W. H. Goldsberry. The actual "author" was the firm, shown here as the publisher. The patent was issued to W. H. Goldsberry.]	Illinois		m W C	247,399
Goldsberry, W. H. <i>See also</i> Thompson & Goldsberry, and <i>The Voice of Fashion.</i>					
Gordon, Seldon Smith					
*1901.	<i>The "Standard" Work on Cutting Ladies' Tailor-Made Garments: A Complete Treatise on the Art and Science of Delineating All Garments for Women Made by Tailors.</i> New York: The Jno. J. Mitchell Co.	New York		W	
1908.	<i>The "Standard" Work on Cutting Ladies' Tailor-Made Garments: A Complete Treatise on the Art and Science of Delineating All Garments for Women Made by Tailors.</i> Revised edition. New York: The Jno. J. Mitchell Co.	New York	illustrated	W	
Gottschalg, William					
1876.	<i>The Art of Measuring, Drawing, and Cutting of Patterns for Ladies' and Children's Dresses</i> Brooklyn: Privately printed.	New York		W	
Le Grand Chic Parisien Fashion Company					
1919.	<i>Instruction Book with Diagrams to the Le Grand Chic Parisien System of Cutting Ladies [sic] and Misses [sic] Tailleurs.</i> Custom edition. New York: Le Grand Chic Parisien Fashion Company.	New York		W	
Greenwood, G. M., & Co.					
1884.	<i>The Improved Franco-American Form . . . an Adjustable Instrument and Perfected Method for Draughting, Cutting, and Fitting Dresses and All Inside and Outside Garments: Instruction in Its Use.</i> Boston: G. M. Greenwood & Co.	Massachusetts	illustrated	W	
Greenwood, George M.					
1890.	<i>Points on Dress Cutting and Fitting, Embracing the Latest Ideas Carried Out in the Leading Emporiums of Fashion of Paris, London, and New York</i> Boston: G. M. Greenwood & Co.	Massachusetts	included	W	
Griffin, Caleb H.					
1879.	<i>"The Challenge" Dress Cutting System.</i> Boston: C. H. Griffin & L. F. Wise.	Massachusetts		W	194,086 195,925 195,926 206,315 228,527 234,273
1879.	<i>The King of Squares: Caleb H. Griffin's Last and Great Improvement in Cutting Ladies' & Children's Garments.</i> Boston: Privately printed.	Massachusetts		W C	194,086 195,925 195,926 206,315 228,527 234,273
1879.	<i>Self-Teaching, Perfect Fitting French System for Cutting Ladies' and Children's Garments.</i> Boston: Privately printed.	Massachusetts		W C	194,086 195,925 195,926

	Publication	State of origin	Drafting tool	Clothing type	U.S. Patent
					206,315
					228,527
					234,273
1883.	<i>Measure and Instruction Book for the United States Standard Dress-Cutting System.</i> Boston: Privately printed.	Massachusetts		W C	194,086
					195,925
					195,926
					206,315
					228,527
					234,273
Griffin, Caleb H., and David Knox					
1873.	<i>The Science and Art of Cutting and Making Ladies' Garments, as Demonstrated by Griffin & Knox's Great American Draughting Machine.</i> Lynn: Privately printed. [Patents issued to Caleb H. Griffin.]	Massachusetts		W	194,086
					195,925
					195,926
					206,315
					228,527
					234,273
Gurney, Edmund					
1917.	<i>Efficiency, Simplicity, Economy In Cutting and Making Ladies' Garments.</i> Portland: Privately printed.	Oregon		W	
Hale, L. B.					
1885.	<i>Simplified Directions for Using L. B. Hale's New Tailor System of French Dress Cutting.</i> Buffalo: Baker, Jones & Co.	New York		W	
Hamilton, Nellie					
1894.	<i>The Scientific System of Dress Cutting Invented by Nellie Hamilton</i> Algona: Privately printed.	Iowa		W	
Hanover, John C., & Co.					
1885.	<i>The Hanover Dressmaker: A New Work on Drafting, Tracing, Cutting, Basting, Stitching, Draping, and Finishing Ladies', Misses', Children's, Boys', and Men's Garments.</i> 1st edition. Cincinnati: John C. Hanover & Co.	Ohio		m W C	
1886.	<i>Hanover's Dressmaker: A New Work on Drafting, Tracing, Cutting, Basting, Stitching, Draping, and Finishing Ladies', Misses', Children's, Boys', and Men's Garments.</i> 2nd edition. Cincinnati: John C. Hanover & Co.	Ohio		m W C	
1886.	<i>Hanover's New and Improved Work on Dressmaking, by the Merchant Tailor System.</i> Cincinnati: John C. Hanover & Co.	Ohio		m W C	
1888.	<i>Hanover's Self-Teaching Garment Cutter, by Merchant Tailor System</i> Cincinnati: John C. Hanover.	Ohio		m W C	
Harvey, S. B.					
1885.	<i>Measure and Instruction Book for the Ladies' Delight Dress-Cutting System.</i> Boston: Privately printed.	Massachusetts		W	
Head, Leola M.					
1888.	<i>Instruction on Leola M. Head's Self Teaching System of Cutting.</i> Haw Ridge: Privately printed.	Alabama		M W C	
Hecklinger, Charles					
1881.	<i>The Dress and Cloak Cutter: A Treatise on the Theory and Practice of Cutting Dresses and Overgarments for Ladies, Especially Designed and Adapted for Tailors' Use.</i> Burlington: Privately printed.	Vermont		W	
1884.	<i>Handbook on Dress and Cloak Cutting.</i> New York: Privately printed.	New York		W	
1886.	<i>Hecklinger's Ladies' Garments, a Text Book: How to Cut and Make Ladies' Garments</i> New York: Privately printed.	New York		W	
1891.	<i>The "Keystone" System: A Text-Book on Cutting and Designing Ladies' Garments.</i> New York: The West Publishing Co.	New York		W	

	<i>Publication</i>	<i>State of origin</i>	<i>Drafting tool</i>	<i>Clothing type</i>	<i>U.S. Patent</i>
1895.	<i>The "Keystone" Jacket and Dress Cutter: A Treatise on Jackets, Dresses, and Other Garments for Women, Specially Designed for Self-Instruction.</i> New York: The Herald of Fashion Co.	New York		W	
	<i>The Herald of Fashion and Journal of Tailoring . . .</i> (1896). New York: The Herald of Fashion Co. [Published monthly, women's wear included in the semiannual supplement.]	New York		m W	
	Herbert, Mrs. Charles				
1897.	<i>Mrs. Herbert's Scientific System of Dress Cutting for Self-Instruction.</i> New York: The Dressmakers' Trade School.	New York		W	
	Holmes, Nelson				
1894.	<i>The Holmes Cutter: A Practical System for Garment Cutting That Is Based on Selfvarying Principles for Block Patterns and the Most Complete for Measurement.</i> Chicago: Privately printed.	Illinois		M w c	
	Hughes & Storey				
1892.	<i>The Ladies' Tailor Complete Instructor.</i> St. Louis: Privately printed. [Patents issued to James R. Storey.]	Missouri	illustrated	m W c	537,132 552,976
	Hunter, A. J.				
1853.	<i>The Garment Cutter and Ladies [sic] Guide: Being a Complete System for Cutting Gentlemen's Wear, Coats of All Fashions, Vests and Pantaloons, Also a Complete Guide for Cutting Ladies [sic] Dressing [sic], with Plain and Practical Rules for Varying and Changing the Same, According to the Change in Fashion, with Plain, Easy, and Practical Method for Teaching the Same by Familiar Questions and Answers, with Explanation on Measure, Pressing, and Finishing Off Clothing.</i> Glasgow: Privately printed.	Kentucky		M W	
	Hurwitz, George				
1910.	<i>New Teacher of Ladies' Home Tailoring.</i> Mason City: Privately printed.	Illinois		W	
	Inwood, Mrs. D. A.				
1863.	<i>Mrs. D. A. Inwood's Book of Instructions for Her Five Measure System of Dress Cutting, for Cutting Ladies' and Children's Dresses, Basques, Boy's Clothing, and Gentlemen's Shirts.</i> Boston: Privately printed.	Massachusetts		m W C	
1871.	<i>Mrs. D. A. Inwood's Book of Instructions for Her Celebrated Diagram of Dress Cutting, for Cutting Ladies' and Children's Dresses, Basques, Boys' Clothing, & c., & c.</i> Boston: Privately printed.	Massachusetts		W C	
1875.	<i>Livre instructeur de Madame D. A. Inwood, pour expliquer la manière de tailleur les robes à l'aide de son célèbre diagramme pour tailler robes de dames et d'enfants basques, vêtements de garçons, etc.</i> Boston: Privately printed.	Massachusetts		W C	
	Jackson, H. Ayers				
1879.	<i>Franco-Prussian Mode.</i> Des Moines: Privately printed.	Iowa		W	259,162 327,172 361,292
1882.	<i>Franco-Prussian Mode.</i> Chicago: Privately printed.	Illinois		W	259,162 327,172 361,292
1884.	<i>H. Ayers Jackson's Scientifically Graduated Waist, Hip Rule, and Sleeve Methods for Ladies', Gentlemen's, and Children's Tailoring, Mathematically Demonstrated and Practically Illustrated.</i> Chicago: Privately printed.	Illinois	included	M W C	259,162 327,172 361,292

	<i>Publication</i>	<i>State of origin</i>	<i>Drafting tool</i>	<i>Clothing type</i>	<i>U.S. Patent</i>
1884.	<i>Scientific Dress Cutting, Practically Illustrated, and Mathematically Demonstrated. The Franco-Prussian Mode "Method" . . .</i> 4th edition. Chicago: Privately printed.	Illinois		W	259,162 327,172 361,292
1888.	<i>Scientific Dress-Cutting Practically Illustrated, and Mathematically Demonstrated. The Franco-Prussian Mode "Method" . . .</i> 6th edition. Chicago: Privately printed.	Illinois		m W C	259,162 327,172 361,292
Jackson, Louisa L.					
*1871.	<i>Self-Teaching System of Garment Cutting: The Family Dress Guide, or, the Art of Drafting and Measuring Simplified and Perfected . . .</i> 8th edition, revised and enlarged. Indianapolis: Privately printed.	Indiana			90,363
1876.	<i>The Science and Geometry of Dress: Being a Complete Manual of Instruction in the Art of Designing, Drafting, and Cutting Ladies' and Children's Wearing Apparel . . .</i> Indianapolis: Privately printed.	Indiana	included	W C	90,363
1876.	<i>The Science and Geometry of Dress: Being a Complete Manual of Instruction in the Art of Designing, Drafting, and Cutting Ladies' and Children's Wearing Apparel . . .</i> Indianapolis: Privately printed.	Indiana	included	W C	90,363
1889.	<i>The Science and Geometry of Dress: Being a Complete Manual of Instruction in the Art of Designing, Drafting, and Cutting Ladies' and Children's Wearing Apparel . . .</i> Indianapolis: Privately printed.	Indiana		W C	90,363
Jester, R. E., & Co.					
1893.	<i>The Merchant Tailor Unabridged Instructor in the Science of Dress Cutting and the Art of Dress Making.</i> Chicago: R. E. Jester & Co.	Illinois	illustrated	W C	
Jones, M. O.					
1891.	<i>Instruction Book, Giving Full Information for Using the Self-Adjusting Tailor System, of Garment Cutting.</i> 4th issue. Rochester: Privately printed.	New York		W C	
	<i>The Journal of Fashion and Tailoring . . .</i> (1893–1894). New York: The West Publishing Co. [Published monthly; included approximately one draft for a woman's garment per issue.]	New York		M w	
Kaphan, M.					
1890.	<i>Prof. M. Kaphan's Kid Glove-Fitting System for Ladies', Misses', Children's, and Gents' Garments . . .</i> Washington, D. C.: Privately printed.	Washington, D.C.		m W C	
Kellogg, Mrs. F. J.					
1880.	<i>Mrs. F. J. Kellogg's Tailor System for Cutting Ladies' Garments of Every Description.</i> Flint: Privately printed.	Michigan		W C	235,776
1888.	<i>Instruction Book for the Kellogg French Tailor System for Cutting Every Description of Ladies' Garments.</i> Battle Creek: Privately printed.	Michigan	included	W	235,776
1889.	<i>Instruction Book for the Kellogg French Tailor System for Cutting Every Description of Ladies' Garments.</i> Battle Creek: Review & Herald Pub. Co.	Michigan	illustrated	W	235,776
1892.	<i>Instruction Book for the Kellogg French Tailor System for Cutting Every Description of Ladies' Garments.</i> Battle Creek: Privately printed.	Michigan	illustrated	W	235,776
King, E.					
1884.	<i>E. King's Scientific Square System of Dress and Cloak Cutting.</i> New York: Privately printed.	New York		W	
Kinslow, Mrs. J. G.					
1888.	<i>The Improved Diagram System of Ladies' and Children's</i>	Massachusetts		W C	

	<i>Publication</i>	<i>State of origin</i>	<i>Drafting tool</i>	<i>Clothing type</i>	<i>U.S. Patent</i>
	<i>Dress and Garment Cutting</i> . Lynn: Privately printed.				
Kintzel, A. G.					
1896.	<i>The Kintzel Dress Cutting System</i> . Philadelphia: Privately printed.	Pennsylvania		W	
Knox, David.	See Caleb H. Griffin.				
Kohler.	See Powell & Kohler.				
Kromer & Flenner					
*1845.	<i>Graduating System, for Drafting Coats, Vests, Pantaloons, Cloaks, & Ladies' Habits</i> . 2nd edition. Philadelphia. [Patent issued to Lewis Flenner.]	Pennsylvania		M w	2,341
Lapsley, William.	See James Queen.				
Leake, Mrs. H. A.					
1883.	<i>A System for Cutting Ladies' Garments (Invented by Mrs. H. A. Leake), a Complete and Reliable Guide for Dress Makers: Instructions for Its Use</i> . Oakland: Privately printed.	California		W	
Legendrè [sic], Madame M. A.					
1889.	<i>Madame Legendrè's [sic] Perfect Fitting System for Cutting Ladies' Garments</i> . Louisville: Privately printed.	Kentucky	illustrated	W	
Levis, D. I.					
1890.	<i>The Parisian Tailor System of Dress Cutting . . .</i> Chicago: Privately printed.	Illinois		W C	
Lewis, S. T.					
1885.	<i>Instructions for Drafting by the Combination Tailor System</i> . Watertown: Privately printed.	New York		W C	321,986
Linthicum, W[illiam] O.					
1876.	<i>Divisional and Exact Measurement Systems for Garment Cutting . . .</i> New York: Privately printed.	New York		M w	
Livingston, J. W.					
1880.	<i>French Combination Instruction Book</i> . New York: Privately printed.	New York		W C	307,664
1884.	<i>French Combination of Squares: Instruction Book</i> . New York: Privately printed.	New York	illustrated	W C	307,664
McCall, James					
1881.	<i>Instruction Book for the French and English Systems of Cutting, Fitting, and Basting</i> . New York. [Final third of book devoted to an explanation of one system used by Moschcowitz Bros.' dressmaking firm.]	New York		W	
McClure, N. C.					
1880.	<i>Practical Dress Cutting with the Square, McClure's Method: Inch Measurement and Square Drafting by the Old Mechanical Rule</i> . Oakland: Pacific Press Publishing House.	California		m W C	
McDermott, L. M.					
1896.	<i>McDermott's New Tapeline Tailor System</i> . Pittsburg: Privately printed.	Pennsylvania	illustrated	W C	
McDowell, Albert.	See <i>The French Dressmaker</i> and <i>La Mode de Paris</i> .				
McDowell Garment Drafting Machine Co.					
1883.	<i>Instruction Book for Drafting and Cutting Dresses, Basques, Sacks, Coats, etc., by the Garment Drafting Machine, As Invented and Patented by A. McDowell</i> . New York: Privately printed. [Patents issued to Albert McDowell.]	New York	illustrated	W	213,436 310,297 342,216
1884.	<i>Instruction Book for Drafting and Cutting Dresses, Basques, Sacks, Coats, &c., by the Garment Drafting Machine, As Invented and Patented by A. McDowell</i> . New York: Privately printed.	New York	illustrated	W	213,436 310,297 342,216

	<i>Publication</i>	<i>State of origin</i>	<i>Drafting tool</i>	<i>Clothing type</i>	<i>U.S. Patent</i>
1885.	<i>Instruction Book for Drafting and Cutting Dresses, Basques, Sacks, Coats, &c., by the Garment Drafting Machine, As Invented and Patented by A. McDowell.</i> 7th edition. New York: Privately printed.	New York		W	213,436 310,297 342,216
1887.	<i>Instruction Book for Drafting and Cutting Dresses, Basques, Sacks, Coats, &c., by the Garment Drafting Machine, As Invented and Patented by A. McDowell.</i> 11th edition. New York: Privately printed.	New York		W	213,436 310,297 342,216
McDowell, William. See <i>Pictorial Review</i> .					
Madison, J. O.					
1878.	<i>Elements of Garment Cutting, Together with Practical Hints to Cutters.</i> Hartford: The Case, Lockwood & Brainard Company.	Connecticut		M w c	
Mahan, Francis					
	<i>Mahan's Protractor and Proof Systems of Garment Cutting, Published and Taught by Francis Mahan, Practical Tailor and Fashioner</i> (1839–1841, 1843–1844, 1854). Philadelphia: Privately printed. [All issues were semi-annual except for 1854, which was quarterly.]	Pennsylvania		M w c	
Mallison, Mme. E. W.					
1886.	<i>Dress Making Reduced to a Science; the Eclectic Lady-Tailor System of Dress Cutting.</i> Washington, D.C.: Privately printed.	Washington, D.C.	illustrated	W	
Martin, G. N.					
1887.	<i>Instructions for Using G. N. Martin's New System of French Dress Cutting.</i> Boston: Privately printed.	Massachusetts		W C	
Martin, James A.					
1888.	<i>Martin's Tailor System for Dress and Cloak or Cutting Dressmaking Self-Taught . . .</i> Peoria: Privately printed.	Illinois		W	
Mason, Ida V.					
1897.	<i>The Independent Cutter: A Scientific Work on Cutting Garments According to a Simple Method.</i> Privately printed.			W	
Miegel, Albert Henry					
1896.	<i>Miegel's Manual of Garment Cutting and Double Measure Systems.</i> Augusta: Privately printed.	Georgia		M w	
Mignogna, Antonio					
1896.	<i>The Tailor's Vade Mecum; or, The Treasure of Experience Converted into Theory on the Art of Cutting Gentlemen's and Ladies' Garments.</i> New York: Privately printed.	New York		M W	
Mirier, E. P.					
1857.	<i>A Self-Teaching Dress Making System: Science Applied to Dress Cutting, the Art Perfected, Simplified and Reduced, in the Process of Drafting, to Mathematical Precision, Accompanied with Copious Illustrations and Examples, with Full and Perfect Directions for Self-Instruction.</i> 2nd edition. Cincinnati: Privately printed.	Ohio		W C	
Mitchell, Jno. J., Co. See: <i>The American Ladies' Tailor</i> ; Jno. A. Carlstrom; S. S. Gordon; <i>The Sartorial Art Journal</i> ; and <i>The Sartorial Art Journal: Ladies' Tailor Edition</i> .					
<i>La Mode de Paris: A Journal of the Latest Fashions for Ladies and Dress-Makers</i> (1891–1895). American Edition. New York and Paris: A. McDowell & Co. [Published monthly. Patents were issued to Albert McDowell.]					
		New York		W	213,436 310,297 342,216
<i>La Mode Universelle: A Book of Pattern Designs with Thompson's Universal System of Garment Cutting</i> (1910). Hartford: Mme. H. J. Hall. [Published semi-annually.]					
		Connecticut		W	

	Publication	State of origin	Drafting tool	Clothing type	U.S. Patent
Molpoer, Louis					
1886.	<i>Every Lady Her Own Dressmaker: The Eureka Lady Tailor System, for Cutting Ladies' Dresses and Coats, No Fitting to Do, Improved and Simplified.</i> Baltimore: Privately printed.	Maryland		W	
1891.	<i>Every Lady Her Own Dressmaker: The Scientific Lady Tailor System for Cutting Ladies [sic] Dresses and Coats, No Fitting to Do, Improved and Simplified.</i> Washington, D.C.: Prof. Lewis [sic] Molpoer.	Washington, D.C.		W	
1895?	<i>Every Lady Her Own Dressmaker: The Scientific Lady Tailor System for Cutting Ladies' Dresses and Coats; No Fitting to Do; Improved and Simplified.</i> 2nd edition. Washington, D.C.: Privately printed.	Washington, D.C.		W	
1897.	<i>Every Lady Her Own Dressmaker: The Scientific Lady Tailor System for Cutting Ladies' Dresses and Coats, No Fitting to Do, Improved and Simplified.</i> 3rd edition. Washington, D.C.: Privately printed.	Washington, D.C.		W	
Montie, Mme.					
1883.	<i>Parisian Method of Cutting without Chart or Scale.</i> Paris: Privately printed.			W	
Moody, D. W.					
1879.	<i>New Instructions for Cutting Children's Clothing by D. W. Moody's Celebrated Star System of Square Measurement.</i> New York: Privately printed.	New York		W C	
1885.	<i>Prof. D. W. Moody's New Book, Giving Complete and Elaborate Instructions in All Branches of Dress Cutting, Dress Making, Sewing, and Basting.</i> 3rd edition. Cincinnati: Privately printed.	Ohio		W C	
1885.	<i>Prof. D. W. Moody's New Book, Giving Complete and Elaborate Instructions in All Branches of Dress Cutting, Dress Making, Sewing, and Basting.</i> 4th edition. Cincinnati: Privately printed.	Ohio		W C	
Moore, C. E.					
1892.	<i>The Self-Instructor.</i> Atlanta: The Atlanta Cutting School.	Georgia		M W	
Moschcowitz. See James McCall.					
Moschcowitz Bros.					
1884.	<i>Instructions in Dressmaking, Basting, and Fitting, as Set Forth by the Moschcowitz Model Waist Lining.</i> New York: Privately printed. [Patents were issued to Herman and Shamu Moschcowitz.]	New York	illustrated	W	246,536 350,073 111,236 327,961
Muller, Ed.					
1892?	<i>A Symposium on Cutting.</i> San Francisco: Privately printed.	California		M w	
Myer, Mary C.					
1884.	<i>Instruction Book for the Paragon Chart.</i>				
Nelson. See Goldsberry, Doran & Nelson.					
Nelson, Jonathan. See <i>The American Modiste.</i>					
<i>The New York Fashion Bazar</i> (1879–1889). New York: George Munro. [Published weekly, with serial article entitled "Cutting-Out and Dressmaking," which gave drafting instructions for one garment per issue.]					
New York					
W C					
Nickerson, S. A.					
1888.	<i>Instruction Book for the Correct Use of Miss S. A. Nickerson's New, Improved, and Scientific Tailor System of Square Measurement for Cutting Ladies' and Children's Garments.</i> Providence: Privately printed.	Rhode Island	illustrated	W C	

	<i>Publication</i>	<i>State of origin</i>	<i>Drafting tool</i>	<i>Clothing type</i>	<i>U.S. Patent</i>
Norman, Mrs. N. R.					
1878.	<i>Lessons on Centennial Patterns No. 2: Norman System Improved . . .</i> St. Louis: Privately printed.	Missouri		M W C	
1880.	<i>Lessons on Centennial Patterns No. 2: Norman System Improved . . .</i> St. Louis: Privately printed.	Missouri		M W C	
1881.	<i>Lessons on Centennial Patterns No. 4: Norman System Improved . . .</i> St. Louis: Privately printed.	Missouri		M W C	
1887.	<i>Lessons on Norman Tailor Square by Diagram with Explanation.</i> St. Louis: Privately printed.	Missouri		M W C	
1896.	<i>Lessons on Centennial Patterns: Norman Tailor System by Diagram with Explanation.</i> St. Louis: Privately printed.	Missouri		M W C	
Olson, Jennie S.					
1887.	<i>Self-Instructor in the Olson New Tailorist System for the Cutting and Making of Garments.</i> Houston: Mrs. Jennie S. Olson.	Minnesota	illustrated	m W C	325,358
Palmer, Mrs. E. E.					
1886.	<i>Instructions in Dress Cutting Complete, with Diagrams Explaining Every Pattern, to Be Used Expressly for the Gem Tailor System . . .</i> Baraboo: Privately printed. [Patent was issued to E. Ellsworth Palmer.]	Wisconsin		W c	252,507
1892.	<i>Instructions in Dress Cutting with Diagrams, etc., Complete, to Be Used Expressly for the Gem Tailor's System of Cutting.</i> Revised edition. Chicago: Privately printed.	Illinois	illustrated	W	252,507
<i>Les Parisiennes</i> (1906–1919). New York: American Fashion Company. [Published ten times per year (June and July omitted).]		New York		W	
Pecori, Eugene					
1912.	<i>Eugene Pecori's Perfect System of Cutting Ladies [sic] Garments.</i> Chicago: Eugene Pecori.	Illinois		W	
Penrose, O. E.					
1893.	<i>Directions for Using the World's Fair Pattern Chart.</i> Springfield: Privately printed.	Illinois		W	
Peyry, Jean B.					
*1896.	<i>Prof. Jean B. Peyry's Instruction Book with Diagram and Measure Book Giving Full and Complete Instructions for Using Prof. Jean B. Peyry's "Système Métrique" Invented for Cutting Ladies', Children's, & Gentlemen's Garments of Every Description—Seam and Seamless: Edition 1896 for Ladies' Garments.</i> New Orleans: Privately printed.	Louisiana		W	626,795
1896.	<i>Livre d'instructions avec diagramme et livre de mesure; traité complet de la coupe et la manière de se servir du "Système Métrique" du Prof. Jean B. Peyry . . . : Ed. 1896 pour habillements de dames et d'enfants.</i> Nouvelle-Orléans: Privately printed.	Louisiana			626,795
1904.	<i>Instructions [sic] Book with Diagrams and Designs for the Conformateur and Systeme Metrique for Cutting Ladies', Children's, and Gentlemen's Garments: New Edition for Ladies' and Children's Garments.</i> New Orleans: Privately printed.	Louisiana	illustrated	W C	626,795
Phelps, Mr. and Mrs. B. T.					
1883.	<i>Instructions for Using the Excelsior Square. A Glove-Fitting System for Ladies' and Children's Garments.</i> 2nd edition. Bellows Falls: Privately printed. [Patent was issued to Brigham T. Phelps.]	Vermont		W C	279,979
1890.	<i>Instructions for Using the Excelsior Square, A Glove-Fitting System for Cutting Ladies' and Children's Garments.</i> 5th edition. Bellows Falls: Privately printed.	Vermont		W C	279,979

	<i>Publication</i>	<i>State of origin</i>	<i>Drafting tool</i>	<i>Clothing type</i>	<i>U.S. Patent</i>
Phelps, E. L.					
1904.	<i>The Scientific Tailor Based on Geometry: A Method of Designing and Drafting Patterns for All Classes of Garments for Men, Women, and Children, to Actual and Composite Measures</i> Volume 1 (Women's Garments). New York?: Privately printed. [The author, who stated that he had taught his system in the United States and Canada, may have been Ernest Leslie Phelps of Toronto, Canada, holder of U.S. Patent 812,874.]	New York	illustrated	W	
	<i>Pictorial Review</i> (1899–1919). New York: American Fashion Company, Inc. [Published monthly; edited by William McDowell after Dec 1899; featured advertisements of A. McDowell & Co.'s drafting tool. Patents were issued to William McDowell.]	New York	illustrated	W C	689,685 787,533 803,778
Potter, H. M.					
1881.	<i>Directions for Measuring and Drafting by H. M. Potter's Practical and Positive Method of Cutting and Designing Ladies', Misses', and Children's Garments.</i> Providence: Privately printed.	Rhode Island		W C	
Powell & Kohler					
1868.	<i>Powell & Kohler's Practical System for Cutting All Kinds of Garments, Especially Designed for the Use of Dressmakers and Private Families.</i> Cincinnati: Powell & Kohler.	Ohio	included	M W	
	<i>The Practical Cutter and Tailor</i> (1893–1897). Chicago: The C. J. Stone Co. [Published monthly.]	Illinois		M W	
Queen, James, and William Lapsley					
1809.	<i>The Tailors' Instructor; or, A Comprehensive Analysis, of the Elements of Cutting Garments, of Every Kind</i> Philadelphia: Privately printed.	Pennsylvania		M w	
Ramsay, John					
1888.	<i>Ramsay's System of Drafting and Cutting Garments in Manual Training Schools.</i> New York: Privately printed.	New York		m W C	
Ratner, Henry Way					
1908.	<i>Ratner's Up-To-Date Method of Designing: School of Designing, Cutting, Grading, and Fitting for Ladies', Gentlemen's, and Children's Garments</i> Chicago: Privately printed.	Illinois		m W C	
Robbins, L. E.					
1875.	<i>The Measurement System of Cutting Dresses.</i> Boston: Privately printed.	Massachusetts		W	
Rontey, P.					
1877.	<i>The Shoulder and Breast Combination: A New System for Drafting Ladies' Waists, Basques, etc., etc.</i> New York: Privately printed.	New York	illustrated	W	
1879.	<i>The Shoulder and Breast Combination: French Graduated System for Drafting Ladies' Waists, Basques, etc., etc.</i> 2nd edition. New York: Privately printed.	New York	illustrated	W	
Rood, Will C.					
1878.	<i>Instructions for Using the Dressmaker's Magic Scale, for Cutting Patterns for Ladies' [sic] and Children's Wearing Apparel: A Perfect Fit Without Change of Seam.</i> San Francisco: Privately printed.	California		W C	
1879.	<i>Instructions for Using the Dressmakers' Magic Scale, Improved and Simplified, for Cutting Ladies' and Children's Wearing Apparel: A Perfect Fit Without Change of Seam.</i> St. Louis: Privately printed.	Missouri		W C	

	<i>Publication</i>	<i>State of origin</i>	<i>Drafting tool</i>	<i>Clothing type</i>	<i>U.S. Patent</i>
1881.	<i>Advanced Studies for Those Using the Dressmakers' Magic Scale . . . Designed for Those Who Have Already Learned to Use the Magic Scale, and Wish to Study Deeper in the Science of Garment Cutting.</i> Quincy: Privately printed.	Illinois		W C	
1882.	<i>Advanced Studies for Those Using the Dressmakers' Magic Scale . . . Designed for Those Who Have Already Learned to Use the Magic Scale and Wish to Study Deeper in the Science of Garment Cutting.</i> 2nd edition. Quincy: Rood & Hayden.	Illinois	illustrated, included	W C	
1889.	<i>Supplement No. 2 to Advanced Studies of Those Using the Dressmakers' Magic Scale, by Will C. Rood.</i> Quincy: The Rood Magic Scale Co.	Illinois		W C	
1892.	<i>Deutsche Anweisungen für den Gebrauch der Magic Scale für Kleidermacherinnen</i> Chicago: The Rood Magic Scale Co.	Illinois		W C	
Rosenbleet, Joel					
1911.	<i>Rosenbleet's Perfect System of Ladies' Garment Cutting Specially Designed for Self Instruction.</i> Los Angeles: Joel Rosenbleet.	California		W	
Rosenfeld, Isidor					
1911.	<i>The Practical Designer for Women's, Misses', Juniors', & Children's Cloaks & Suits, Shirt Waist Suits, and Dresses with Grading and Special Measurements According to the Most Approved & Up-To-Date Method</i> New York: Privately printed.	New York	illustrated	W C	
1918.	<i>The Practical Designer: An Encyclopedia to Designers and Cutters for Women's, Misses', Juniors', Children's, and Infants' Jackets, Coats, Capes, Waists, Skirts, Riding Habits, Dresses, and Underwear.</i> 11 volumes. Revised edition. New York: The Leading Pattern Co.	New York		W C	
Ross, Mrs. H. A.					
1882.	<i>Instructions for Using Mrs. Ross' Tailor System, for Cutting Ladies' and Children's Garments of All Kinds.</i> Battle Creek: Privately printed.	Michigan		W C	
1887.	<i>The Ross Tailor System of Garment Cutting by Actual Measurements.</i> 2nd edition. Battle Creek: Privately printed.	Michigan	illustrated,	W C	
Rouwel & Co.					
*1874.	<i>Rouwel & Co.'s Geometrical and Scientific Work on the Art of Cutting Gentlemen [sic] and Ladies' Garments.</i> New York: Rouwel & Co.	New York		M W	
Royal Pattern Co.					
1896.	<i>Instruction Book of the Royal System for Cutting Ladies' Garments.</i> New York: The Royal Pattern Co.	New York	illustrated	W	
Rude, A. D., & Son					
1900.	<i>Text Book of the Great Modern System for Designing and Cutting Ladies' Garments</i> New York: Privately printed.	New York		W	
Russell, Maude W[esterman]					
1917.	<i>The Maude Russell System of Garment Cutting: Text Book</i> Oklahoma City: Maude Russell Garment Cutting Co.	Oklahoma	illustrated	W	1,149,468
<i>The Sartorial Art Journal: The American Fashion Review</i> (Jul 1884–Mar 1885, 1889–1919). New York. [Issued monthly; 1889–1919 issues published by The Jno J. Mitchell Co., New York; originally published as <i>The American Fashion Review</i> .]		New York		M w	

	<i>Publication</i>	<i>State of origin</i>	<i>Drafting tool</i>	<i>Clothing type</i>	<i>U.S. Patent</i>
	<i>The Sartorial Art Journal: Ladies' Tailor Edition</i> (1900–1903). New York: The Jno. J. Mitchell Co. [Published quarterly. Tool included in some issues.]	New York	included	W	
Schoenfelder, H.	1879. <i>H. Schoenfelder's New and Improved Method of Cutting All Kinds of Ladies</i> [sic] <i>Garments</i> . New York: Privately printed.	New York	included	W	
Schorr, Saul	1915. <i>The American Designer and Cutter: A Complete, Practical and Up-To-Date Work on the Art of Designing, Cutting, Grading, Fitting, Sketching, and Practical Tailoring of All Kinds of Womens'</i> [sic], <i>Misses', Juniors', Childrens'</i> [sic], <i>and Infants' Garments</i> . New York: American Pattern Co.	New York		W C	
	*1917. <i>The Expert Designer: A Practical and Up-To-Date Work on the Art of Designing and Pattern-Making of Women's Cloaks, Suits, Waists, Dresses, and Skirts . . .</i> New York: American Pattern Co.	New York		W	
Sheifer, N. S.	1908. <i>N. S. Sheifer's System of Designing and Grading Ladies', Misses' & Children's Garments . . .</i> New York: Privately printed.	New York		W C	
Sheifer, N. S.	<i>See also</i> Louis Dittmar.				
Sipe, Mrs. T. E.	1887. <i>Self-Instructor to the Independent Tailor System</i> . Privately printed. [Patent granted to Thalia E. Sipe, New York, New York.]			W	497,503
Smith, A[lfred] E.	1885. <i>The Triangular Method for Cutting Ladies', Children's, and Men's Garments</i> . Detroit: L. A. Smith & Co.	Michigan		m W C	
Snow, Lester J.	1912. <i>Instruction Book: Snow's Success System of Garment Cutting, a Tailor System Based upon the Latest Accepted Theories of Dress Cutting</i> . 6th edition. Rockford: Privately printed.	Illinois	illustrated	W C	
	1917. <i>Instruction Book: Snow's Success System of Garment Cutting, a Tailor System Based upon the Latest Accepted Theories of Dress Cutting</i> . 8th edition. Rockford: Privately printed.	Illinois	illustrated	W C	
Spikman, Frins	1918. <i>The U.S.A. System of Ladies</i> [sic] <i>& Gentlemen's Garments</i> [sic] <i>Cutting</i> . Buffalo: Frins Spikman.	New York		M w	
Stearns, Mrs. B. A.	1892. <i>A System for Cutting Ladies' and Children's Garments by Tailor's Method with Stearns' Improved Diagram</i> . Boston: Privately printed.	Massachusetts	illustrated	W	
Steuernagel, C.	1885. <i>The New Practical Cutter: A Treatise on the Science and Practice of Cutting Ladies' Garments, Containing New, Systematic and Practical Instructions . . .</i> Cleveland: Lauer & Yost.	Ohio	illustrated	W	
Stinemets, William H.	*1844. <i>A Complete and Permanent System of Cutting All Kinds of Garments, to Fit the Human Form, on a New and Scientific Principle, with Copious Remarks on the Admeasurements . . .</i> New York: Privately printed.	New York			
Stone, Charles J[ohn]	1897. <i>Superlative System of Cutting Ladies' Garments Based</i>	Illinois		W	

	Publication	State of origin	Drafting tool	Clothing type	U.S. Patent
	<i>Upon a Scientific, Sure, and Simple Method Giving the Correct Proportions for Each Type of Form of Every Size</i> Chicago: Chas. J. Stone Co. Cutting School.				
1901.	<i>New Superlative System of Cutting Ladies' Garments Based upon a Scientific, Sure, and Simple Method Giving the Correct Proportions for Each Type of Form of Every Size, with Variations for All Kinds of Disproportionate Shapes and Forms.</i> Chicago: Chas. J. Stone Co. Cutting School.	Illinois	included	W	
	Storey [James R.]. See Hughes & Storey.				
	Studabecker, J. A.				
1881?	<i>Dress and Cloak Fitting Made Easy: Instructions for Drafting, by Studabecker's Tailors' Square for Cutting Ladies' and Childrens' [sic] Clothing.</i> San Francisco: Privately printed.	California	included	m W C	
	Swarz, Maurice				
1889.	<i>Maurice's System of Dress Cutting.</i> New York: Privately printed.	New York		W	
	<i>The Tailor's Review . . .</i> (1883–1903). London and New York: The Butterick Publishing Co. [Published monthly. Drafts for women's garments were included in the magazine after 1898.]	New York		M W	
	Tappan, Frank O., and Lillian A. Eggleston				
1896.	<i>Directions for Taking Measures.</i> Toledo: Privately printed.	Ohio		M W C	
	Taylor, Mary A.				
1893.	<i>The Bona Fide American Dress Cutting System, Consisting of 65 Illustrations.</i> Passaic: Privately printed.	New Jersey	illustrated	W	234,821
	Taylor, S. T.				
*1869.	<i>A System for Cutting Ladies' Garments.</i> New York: S. T. Taylor.	New York			
1871.	<i>A System for Cutting Ladies' Garments, Invented by S. T. Taylor</i> New York: S. T. Taylor.	New York	illustrated	W	
1873.	<i>A System for Cutting Ladies' Garments, Invented by S. T. Taylor</i> New York: S. T. Taylor.	New York	illustrated	W	
1875.	<i>A System for Cutting Ladies' Dresses, Invented by S. T. Taylor</i> New York: Sarah E. Taylor.	New York	partially illustrated	W	
1877.	<i>A System for Cutting Ladies' Garments, Invented by S. T. Taylor</i> New York: Sarah E. Taylor.	New York	partially illustrated	W	
1879.	<i>A System for Cutting Ladies' Garments Invented by S. T. Taylor</i> Revised edition. New York: Sarah E. Taylor.	New York	partially illustrated	W	
1879.	<i>A System for Cutting Ladies' Garments Invented by S. T. Taylor</i> New edition. New York: Sarah E. Taylor.	New York	illustrated	W	
1880.	<i>A System for Cutting Ladies' Garments, Invented by S. T. Taylor</i> New edition. New York: Sarah E. Taylor.	New York	partially illustrated	W	
1881.	<i>A System for Cutting Ladies' Garments Invented by S. T. Taylor</i> New edition. New York: Sarah E. Taylor.	New York	illustrated	W	
1881.	<i>A System for Cutting Ladies' Garments, Invented by S. T. Taylor</i> New edition. New York: S. T. Taylor.	New York	partially illustrated	W	
1883.	<i>A System for Cutting Ladies' Garments Invented by S. T. Taylor</i> Revised edition. New York: S. T. Taylor.	New York	illustrated	W	
1896.	<i>S. T. Taylor's System of Dress Cutting.</i> New York: S. T. Taylor Co.	New York		W	

	<i>Publication</i>	<i>State of origin</i>	<i>Drafting tool</i>	<i>Clothing type</i>	<i>U.S. Patent</i>
Taylor, S. T., Co.					
1911.	<i>Instruction Book with Diagrams for S. T. Taylor's System of Cutting Ladies' Garments.</i> New York: S. T. Taylor Co.	New York	illustrated	W	
1913.	<i>Instruction Book with Diagrams for S. T. Taylor's System of Cutting Ladies' Garments.</i> New York: S. T. Taylor Co.	New York	illustrated	W	
1915.	<i>Instruction Book with Diagrams for S. T. Taylor's System of Cutting Ladies' Garments.</i> New York: S. T. Taylor Co.	New York	illustrated	W	
1919.	<i>Instruction Book with Diagrams for S. T. Taylor's System of Cutting Ladies' Garments.</i> New York: S. T. Taylor Co.	New York	illustrated	W	
Teague, Louisa					
1895.	<i>Complete Instructions for Mrs. Louisa Teague's Self-Teaching Dress Chart.</i> Goldthwaite: Mrs. Louisa Teague.	Texas		W	
Tentler, Aaron A.					
1842.	<i>A New System for Measuring and Cutting Ladies' Dresses, Cloaks, Collars, Capes, Yokes, &c., with an Arithmetical Table, for Which the Author Received a Patent from the United States, January 23, 1841.</i> Philadelphia: Privately printed.	Pennsylvania		W	1,944
Tessmer, A.					
1889.	<i>Das Buch zum Gelbstunerrichten im Schnittmusterzeichnen und Zuschneiden</i> New York: Privately printed.	New York		W	
1890.	<i>Das Buch zum Gelbstunerrichten im Schnittmusterzeichnen und Zuschneiden.</i> New York: Privately printed.	New York	illustrated	W	
Thompson, F. E.					
1881.	<i>Thompson's Universal Garment Cutter.</i> Webster City: Privately printed.	Iowa		M W C	
1884.	<i>Thompson's Universal Garment Cutter.</i> Kansas City: Privately printed.	Missouri		m W c	
1884.	<i>Thompson's Universal Garment Cutter.</i> Kansas City: Privately printed.	Missouri		m W c	
1884.	<i>Thompson's Universal Garment Cutter.</i> Kansas City: Privately printed.	Missouri		m W c	
1888.	<i>Thompson's Universal Garment Cutter.</i> Kansas City: Privately printed.	Missouri		m W c	
1891.	<i>Thompson's Universal Garment Cutter.</i> Kansas City: Hudson-Kimberly Pub. Co.	Missouri		m W c	
Thompson, Mrs. F. E. [Bertha]					
1887.	<i>Thompson's New Improved Garment Cutter.</i> Kansas City: Mr. and Mrs. F. E. Thompson.	Missouri		m W c	
1892.	<i>Thompson's Universal Garment Cutter.</i> Kansas City: Hudson-Kimberly Pub. Co.	Missouri		m W c	
1895.	<i>Thompson's Universal Garment Cutter.</i> Kansas City: Hudson-Kimberly Publishing Co.	Missouri		m W c	
1895.	<i>Thompson's Universal Garment Cutter Fashion Magazine.</i> Kansas City: Privately printed.	Missouri		m W c	
Thompson & Goldsberry					
1880.	<i>Thompson & Goldsberry's Self-Fitting Garment Cutters.</i> Webster City: Privately printed. [Patent was issued to W. H. Goldsberry.]	Iowa	included	M W	247,339
Thorp, Theodore					
1882.	<i>Thorp's New York System of Dress Cutting: A System for Cutting Basques, Ulsters, Jackets, Circular Cloaks, and Dolmans</i> Rochester: Privately printed.	New York		W	
1884.	<i>Thorp's New York System of Dress Cutting.</i> New York: Privately printed.	New York		W	

	Publication	State of origin	Drafting tool	Clothing type	U.S. Patent
1886.	<i>Thorp's New York System of Dress Cutting</i> . New York: Privately printed.	New York		W	
Tobey, Madame					
1889?	<i>Directions for Drafting by Madame Tobey's Improved Glove-Fitting System for Dress Cutting</i> . Augusta: Privately printed. [Filed at the Library of Congress in 1889.]	Maine		W C	
Treadway, E. P.					
1882.	<i>The Franco-American Form: A Variable Diagram for Fitting Dresses and Other Garments . . .</i> . Philadelphia: Privately printed.	Pennsylvania	illustrated	W	
Turner, Milo M.					
1882.	<i>Turner's Improved Self-Instructing System for Drafting Ladies', Misses', and Children's Clothing</i> . Book I. Cincinnati: Privately printed.	Ohio		W C	46,409
1883.	<i>Turner's Improved Tailor System for Drafting Ladies [sic], Misses [sic] and Children's Clothing</i> . Book II. Cincinnati: Privately printed.	Ohio		W C	46,409
1883.	<i>Turner's Improved Sleeve System for Drafting Ladies [sic], Misses [sic], and Children's Coat, Plain, Gathered, and Puffed Sleeves</i> . Book III. Cincinnati: Privately printed.	Ohio		W C	46,409
1884.	<i>Milo M. Turner's Improved Tailor System, by Mrs. N. J. Turner's Form: Wrought Patterns, for Drafting Ladies [sic], Misses [sic], and Children's Clothing</i> . Cincinnati: Privately printed.	Ohio		W C	46,409
1885.	<i>Milo M. Turner's Improved System of Drafting, by Inch Rule and Tape Measure</i> . Cincinnati: Privately printed.	Ohio		W	46,409
1889.	<i>Milo M. Turner's Improved Tailor System, by Mrs. N. J. Turner's Form: Wrought Patterns, for Drafting Ladies [sic], Misses [sic], and Children's Clothing</i> . Books I and II in one volume. Cincinnati: Privately printed.	Ohio		W C	46,409
Vienna Ladies' Tailoring Institute					
1896?	<i>Artistic Ladies' Tailor System</i> . New York: Vienna Ladies' Tailoring Institute.	New York	illustrated	W C	
1898.	<i>Artistic Ladies' Tailor System</i> . New York: Vienna Ladies' Tailoring Institute.	New York	illustrated	W C	
1902.	<i>Twentieth Century Instruction Book: Artistic Ladies' Tailor System</i> . New York: Vienna Ladies' Tailoring Institute.	New York		M W C	
Vogel, Franz Otto					
1883.	<i>Practical Hand-Book for Tailors & Seamstresses for Self-Instruction . . .</i> . St. Louis: Privately printed.	Missouri		M w c	
<i>The Voice of Fashion</i> (1890–1896, 1901–1905). Chicago. [Published quarterly by Goldsberry, Doran & Nelson (1890–1892) and by Goldsberry & Doran (1892–1896); semi-annually by C. A. DeGryse (1901–1904) and by Voice of Fashion Pub. Co. (1904–1905). Tool illustrated 1901–1905. Patent issued to W. H. Goldsberry.]					
Walker, Mrs. H. M., and W. A. Work					
1885.	<i>Madam Walker's Champion Fitter, a Self-Instructor in the Science of Cutting and Fitting All the Garments Worn by Ladies, Gentlemen, and Children</i> . Chicago: Privately printed.	Illinois		M W C	
Walkie, Madame [Jennie]					
1888.	<i>Instruction Book for the Celebrated Worth Tailor System</i> . Chicago: Privately printed.	Illinois		W C	452,090

	<i>Publication</i>	<i>State of origin</i>	<i>Drafting tool</i>	<i>Clothing type</i>	<i>U.S. Patent</i>
Wallace, William					
1881.	<i>Dress-Fitting without a Teacher.</i> Oakland: Pacific Press Publishing House.	California	illustrated	W	284,783
Walsh, James J.					
1915.	<i>Fit-U-First Dress-Making & Tailoring Schools, Kansas City, Mo.</i> Kansas City: Privately printed.	Missouri	illustrated	W	
Weidel, J[oseph] A[nton]					
1910.	<i>Weidel's Instruction Book for Those Using Weidel's Combined Tailor Square and Curves: A Complete Treatise on Drafting Ladies' and Children's Garments by the Square and Curves Combined.</i> St. Louis: Weidel & Webster.	Missouri	illustrated	W C	981,043
1914	<i>Weidel's Instruction Book for Those Using Weidel's Combined Tailor Square and Curves: A Complete Treatise on Drafting Ladies' and Children's Garments by the Square and Curves Combined.</i> St. Louis: Weidel Ladies' Tailoring College Co.	Missouri	illustrated	W C	981,043
Weiler, S. G.					
1915.	<i>The Weiler Ladies [sic] Tailor-Dressmaker Designer, Cutter, and Fitter Book.</i> Milwaukee: S. G. Weiler Designer.	Wisconsin	illustrated	W	1,163,874
Weinberg, Benjamin					
1900.	<i>Weinberg's Cloak, Skirt, and Cape Cutter: A Simple and Perfect Method for Self Instruction on the Art of Cutting Ladies' Cloaks, Skirts, and Capes.</i> New York: Privately printed.	New York	illustrated, included	W	
Welander, A. W.					
1896.	<i>Welander's Perfected Combination System Based upon Practical, Sure, and Simple Methods, Giving the Exact Balance and Proportions for Each and Every Type and Form.</i> Chicago: A. W. Welander.	Illinois		M w	
1898.	<i>Welander's Perfected Tailor System for Dress Cutting: For Use of Dressmakers, Ladies [sic] Tailors, and Furriers.</i> Chicago: A. W. Welander.	Illinois		W	
Wendorf, William					
1913.	<i>Wendorf's Practical Cutting Method: A New System Which Enables One to Take Correct Measurements and Draft Patterns for Ladies' and Men's Garments.</i> Chicago: Privately printed.	Illinois	illustrated	M W	1,042,063
Wetterhall, O. L.					
1890.	<i>Devereaux's French System of Actual Measure for Scientific Dress and Sleeve Cutting.</i> Oconomowoc: Privately printed.	Wisconsin		W C	
Wheeler, E[lla] C.					
1885.	<i>Instructions for Draughting Garments by the Improved Scientific Method.</i> Boston: Privately printed.	Massachusetts		W	
Wheeler & Wilson					
1881.	<i>The New Science of Dress Cutting by the Wilson Method of Inch Measurement.</i> San Jose: [E. W.] Wheeler & [J. A.] Wilson. [Although the authors, E. W. Wheeler and James A. Wilson, possibly hoped to be confused with the east-coast sewing machine firm headed by A. B. Wilson and Nathaniel Wheeler, there was no apparent connection between the two companies.]	California	included	W C	
Whitmore, Thomas H.					
1852.	<i>T. H. Whitmore's Systems for Cutting Garments, Containing Directions and Illustrations for Measuring and Draughting, to Cut All Kinds of Gentlemen's Garments, Including Dress, Frock, Sack, and Over Coats, Pantaloons,</i>	Ohio		M W	

	Publication	State of origin	Drafting tool	Clothing type	U.S. Patent
	<i>Vests, Cloaks, and Ladies' Dresses.</i> Deerfield: Privately printed.				
Williams, W. R.					
1889.	<i>W. R. Williams' New Instruction Book, Giving Full and Complete Instructions for Using the Perfection Tailor System of Dress Cutting.</i> Lawrence: Privately printed.	Kansas	illustrated	W C	660,175
1893.	<i>W. R. Williams' New Instruction Book Giving Full and Complete Instructions for Using the New Perfection System of Dress Cutting.</i> Lawrence: Privately printed.	Kansas	illustrated	W C	660,175
Wilson, J. A. See E. W. Wheeler.					
Wilson, J. A., & Co.					
1883.	<i>Instructions for Drafting by Wilson's New Tailor-System of Dress Cutting.</i> Chicago: J. A. Wilson & Co.	Illinois		W	
Wilson, Mrs. J. A., & Co.					
1885.	<i>Wilson's New Tailor-System of Dress Cutting.</i> San Jose: J.A. Wilson & Co.	California		W	
Wilson, James A.					
1880.	<i>The Science of Dress Cutting by the Wilson Method of Inch Measurement.</i> San Jose: Privately printed.	California	included	W	
Wilson, James G.					
1827.	<i>Report of the Present Fashions, with the Square Rules and Variations to Fit the Human Shape.</i> New York: Privately printed.	New York		M w c	4,687X 7,566X
Wing, Mona H.					
1895.	<i>The Nineteenth Century Cutting System.</i> Chicago: Privately printed.	Illinois		W C	
Woolman, H[ester] A[nn] S[harp]					
1913.	<i>Métoda "Acme" (moda científica) para el arte de cortar y confeccionar toda clase de ropa sin necesidad de maestro contiene dibujos de prendas de vestir para señoras, caballeros, y niños.</i> Volume 2. New York: The Clover Press. [Patent was issued to Edwin Z. Lesh and Hester A. Woolman, who were United States citizens residing in Guadalajara, Mexico.]	New York	illustrated	m W c	825,915
Work, W. A. See Mrs. H. M. Walker..					
Work, W[illiam] A[lbert]					
1914.	<i>Work's Ladies' Tailor System: A Self Instructor in the Art of Cutting and Fitting Ladies' Garments.</i> Harrisburg: Privately printed. [Published quarterly.]	Pennsylvania		W	
Wuerfel, Augusta J.					
1889.	<i>Mrs. A. J. Wuerfel's Tailor's Rules and Diagrams, Instruments Patented, June 7th, 1887</i> Milwaukee: Privately printed.	Wisconsin		W C	364,620
1900.	<i>Mrs. A. J. Wuerfel's Tailor's Rules and Diagrams, Instruments Patented June 7th, 1887</i> Milwaukee: Privately printed.	Wisconsin		W C	364,620
Zeisler, Alexander Z.					
1917.	<i>Parisian Ladies' Tailoring System for Designing, Pattern Cutting, Fitting, and Making Waists, Skirts, Dresses, Suits, and All Outer Garments.</i> Chicago?: The Excelsior Dry Goods Co.?	Illinois		W	
Zenith Manufacturing Co.					
1904.	<i>Instructions for Using Zenith Impression System of Garment Drafting.</i> Rochester: Zenith Manufacturing Co. [Patents issued to Edward P. Follett, the last one assigned by him to the Zenith Manufacturing Co.]	New York	illustrated	W	389,376 389,377 566,158 583,858 611,995 692,510 735,738

Chronological Index to Authors

1809. Queen, James, and William Lapsley
1827. Wilson, James G.
- 1839–1841. Mahan, Francis
1842. Tentler, Aaron A.
- 1843–1844. Mahan, Francis
1844. Stinements, William H.
1845. Kromer & Flenner
1852. Whitmore, Thomas H.
1853. Hunter, A. J.
1854. Mahan, Francis
1856. Dilday, E.
1857. Minier, E. P.
1859. Clavé, Justin
1863. Inwood, Mrs. D. A.
1868. Powell & Kohler
1869. Ewing, Sarah C.
Taylor, S. T.
1871. Ewing, Sarah C.
Inwood, Mrs. D. A.
Jackson, Louisa L.
Taylor, S. T.
1873. Griffin, Caleb H., and David Knox
Taylor, S. T.
1874. Rouwel & Co.
1875. Inwood, Mrs. D. A.
Robbins, L. E.
Taylor, S. T.
1876. Gottschalg, William
Jackson, Louisa L.
Linthicum, W[illiam] O.
1877. Rontey, P.
Taylor, S. T.
1878. Madison, J. O.
Norman, Mrs. N. R.
Rood, Will C.
1879. Griffin, Caleb H.
Jackson, H. Ayers
Moody, D. W.
Rontey, P.
Rood, Will C.
Schoenfelder, H.
Taylor, S. T.
- 1879–1889. *The New York Fashion Bazar*
1880. Kellogg, Mrs. F. J.
Livingston, J. W.
McClure, N. C.
Norman, Mrs. N. R.
Taylor, S. T.
Thompson, & Goldsberry
Wilson, James A.
1881. Hecklinger, Charles
McCall, James
Norman, Mrs. N. R.
Potter, H. M.
Rood, Will C.
- Taylor, S. T.
Thompson, F. E.
Wallace, William
Wheeler & Wilson
- 1881? Studabecker, J. A.
1882. Byrnes, T[homas] W.
Davis, Mrs. M. E.
Jackson, H. Ayers
Rood, Will C.
Ross, Mrs. H. A.
Thorp, Theodore
Treadway, E. P.
Turner, Milo M.
1883. Bayne, J. Reid
Cornwell, Willett
Devereaux, C. A.
Elliss, Amelia B.
Fitch, Morris
Fountain, J. H.
Griffin, Caleb H.
Leake, Mrs. H. A.
McDowell Garment Drafting
Machine Co.
Montie, Mme.
Phelps, Mr. and Mrs. B. T.
Taylor, S. T.
Turner, Milo M.
Vogel, Franz Otto
Wilson, J. A., & Co.
- 1883–1903. *The Tailor's Review*
1884. Carman & Blaney
Gartland, Elizabeth
Goldsberry, W. H.
Greenwood, G. M., & Co.
Hecklinger, Charles
Jackson, H. Ayers
King, E.
Livingston, J. W.
McDowell Garment Drafting
Machine Co.
Moschcowitz Bros.
Myer, Mary C.
Thompson, F. E.
Thorp, Theodore
Turner, Milo M.
- 1884–1885. *The Sartorial Art Journal: The American Fashion Review*
1885. Cornwell, Willett
Ganzhorn, William
Goldsberry, W. H.
Hale, L. B.
Hanover, John C., & Co.
Harvey, S. B.
Lewis, S. T.
McDowell Garment Drafting
Machine Co.
Moody, D. W.
- Smith, A[lfred] E.
Steuernagel, C.
Turner, Milo M.
Walker, Mrs. H. M., and W. A. Work
Wheeler, E[lla] C.
Wilson, Mrs. J. A., & Co.
1886. Goldsberry, W. H.
Hanover, John C., & Co.
Hecklinger, Charles
Mallison, Mme. E. W.
Molpoer, Louis
Palmer, Mrs. E. E.
Thorp, Theodore
1887. Buddington, Mr. and Mrs. F. E.
Coleman, Mrs. M[ary] V[irginia]
Doughty & Co.
Goldsberry, W. H.
McDowell Garment Drafting
Machine Co.
Martin, C. N.
Norman, Mrs. N. R.
Olson, Jennie S.
Ross, Mrs. H. A.
Sipe, Mrs. T. E.
Thompson, Mrs. F. E. [Bertha]
1888. Cornwell, Willett
Davis, Myra A.
Dittmar & Sheifer
Elmes, B. S.
Ewing, Sarah C.
Goldsberry, W. H.
Hanover, John C., & Co.
Head, Leola M.
Jackson, H. Ayers
Kellogg, Mrs. F. J.
Kinslow, Mrs. J. G.
Martin, James A.
Nickerson, S. A.
Ramsay, John
Thompson, F. E.
Walkie, Madame [Jennie]
1889. Abercrombie, Emma
Briggs, D. B.
Goldsberry, W. H.
Jackson, Mrs. Louisa L.
Kellogg, Mrs. F. J.
Legendrè [sic], Madame M. A.
Rood, Will C.
Swarz, Maurice
Tessmer, A.
Turner, Milo M.
Williams, W. R.
Wuerfel, Mrs. Augusta J.
- 1889–1919. *The Sartorial Art Journal: The American Fashion Review*
- n.d. (c. 1889). Tobey, Madame

1890. Bearrie, A. E., & Co.
Fountain, J. H.
Levis, D. I.
Goldsberry, W. H.
Greenwood, George M.
Kaphan, M.
Phelps, Mr. and Mrs. B. T.
Tessmer, A.
Wetterhall, O. L.
- 1890–1892. *The Voice of Fashion*
- 1890–1897. *Custom Cutter*
1891. Clute, J. Redfield
Denny, Mrs. L.
Dittmar & Sheifer
Goldsberry, W. H.
Hecklinger, Charles
Jones, M. O.
Molpoer, Louis
Thompson, F. E.
- 1891–1895. *La Mode de Paris*
1892. Barnes, A. L.
Baughman, Mr. and Mrs. J. S.
deLamorton, O. H.
Goldsberry, W. H.
Hughes & Storey
Kellogg, Mrs. F. J.
Moore, C. E.
Palmer, Mrs. E. E.
Rood, Will C.
Stearns, Mrs. B. A.
Thompson, Mrs. F. E. [Bertha]
- 1892? Muller, Ed.
- 1892–1896. *The Voice of Fashion*
1893. Bell, Mattie M.
Goldsberry, W. H.
Jester, R. E., & Co.
Penrose, O. E.
Taylor, Mary A.
Williams, W. R.
- 1893–1894. *The Journal of Fashion and Tailoring*
- 1893–1897. *The Practical Cutter and Tailor*
1894. Hamilton, Nellie
Holmes, Nelson
- 1894–1895. *The French Dressmaker*
1895. Bisbee, F. S.
Fourier, P.A.
Goldsberry, W. H.
Hecklinger, Charles
Teague, Louisa
- Thompson, Mrs. F. E. [Bertha]
Wing, Mona H.
- 1895? Molpoer, Louis
1896. Buddington, Mr. and Mrs. F. E.
Evan, H. P., Co.
Goldsberry, W. H.
The Herald of Fashion and Journal of Tailoring
Kintzel, A. G.
McDermott, L. M.
Miegel, Albert Henry
Mignogna, Antonio
Norman, Mrs. N. R.
Peyry, Jean B.
Royal Pattern Co.
Tappan, Frank O., and Lillian A. Eggleston
Taylor, S. T.
Welander, A. W.
- 1896? Vienna Ladies' Tailoring Institute
1897. Blair, Margaret J.
Goldsberry, W. H.
Herbert, Mrs. Charles
Mason, Ida V.
Molpoer, Louis
Stone, Charles J[ohn]
1898. Vienna Ladies' Tailoring Institute
Welander, A. W.
- 1899–1919. *Pictorial Review*
1900. Denieffe, Joseph
Rude, A. D., & Son
Weinberg, Benjamin
Wuerfel, Augusta J.
- 1900–1903. *The Sartorial Art Journal: Ladies' Tailor Edition*
1901. Doolittle, Oliver Taylor
Gordon, Seldon Smith
Stone, Charles J[ohn]
- 1901–1904. *The Voice of Fashion*
1902. Brown, Harriet A[delaid]
Vienna Ladies' Tailoring Institute
1903. *The American Modiste*
Diamond Garment Cutter
Correspondence School
- 1903–1919. *The American Ladies' Tailor*
1904. Blair, Margaret J.
Engelmann, Gustav
Peyry, Jean B.
- Phelps, E. L.
Zenith Manufacturing Co.
- 1904? Berkowich, Louis I., editor
- 1904–1905. *The Voice of Fashion*
- 1904–1913. *The American Modiste*
1905. Carlstrom, Jno. A.
Diamond Garment Cutter
Correspondence School
- 1906–1919. *Les Parisiennes*
1907. Blakely, Elizabeth, and Frances Patton
Gingles, Mae Milbourne
Gordon, Seldon Smith
Ratner, Henry Way
Sheifer, N. S.
1909. Glickstein, Philip
1910. Hurwitz, George
La Mode Universelle
Weidel, J[oseph] A[nton]
1911. Rosenbleet, Joel
Rosenfeld, Isidor
Taylor, S. T., Co.
1912. Pecori, Eugene
Snow, Lester J.
- 1912–1918. *The Fashionable Woman's Tailor*
1913. Engelmann, Gustav
Taylor, S. T., Co.
Wendorf, William
Woolman, H[ester] A[nn] S[harp]
1914. Bennett, Ella Alvira
Weidel, J[oseph] A[nton]
Work, W[illiam] A[lbert]
1915. Ferguson, Albert Edwin
Schorr, Saul
Taylor, S. T., Co.
Walsh, James J.
Weiler, S. G.
1917. Blackburn, Juditha
Gurney, Edmund
Russell, Maude W[esterman]
Schorr, Saul
Snow, Lester J.
Zeisler, Alexander Z.
1918. Rosenfeld, Isidor
Spikman, Frins
1919. Le Grand Chic Parisien Fashion Company
Taylor, S. T., Co.

Appendix II

Dressmakers' Drafting Tools at Library of Congress (Uncatalogued, in the collection of the Prints and Photographs Division)

<i>Copyright holder</i>	<i>Residence</i>	<i>Year of copyright</i>	<i>Size</i>
Chappell, James H.	Pennsylvania	1853	57.2 × 57.2 cm
Cox & Minton	Danville, Indiana	1868	66.2 × 57.0 cm
Holbrook & Co.	Massachusetts	1870	78.1 × 63.2 cm
McCall, James	New York	1867	62.2 × 46.0 cm
McKim & Noel	St. Louis, Missouri	1867	71.8 × 52.7 cm

Appendix III

Patents for Drafting Systems for Assorted Clothing

Patents related to drafting patterns for women's garments are included in this listing. Most of these were for drafting garments for the upper torso. Sometimes methods for cutting sleeves were included; there were a few patents which were specifically for this purpose. Before the 1890s, skirts were not drafted. In the first half of the century skirts were simply gathered or pleated at the waist; in the 1860s they were cut with side gores but were still gathered or pleated in back to fit the waist; during the last quarter of the century they were draped on the customer, on an assistant, or on a dress form. In the last decade of the 19th century, however, skirts were sometimes included in dress cutting systems. Patents were also granted for separate skirt cutting systems. These patents are designated by the word "skirts" in brackets when the titles do not clearly identify them.

Many patents for tailors' systems are also included in this list. As reflected by the patents, tailors were responsible for the original development of, and the earliest improvements to, drafting

systems. Sometimes these systems included techniques for cutting women's apparel such as ladies' riding habits. Occasionally it is not obvious whether a technique was intended to be used for drafting specifically men's or women's garments. This appendix lists, however, only those patented tailors' techniques that could be related to the technology of drafting women's garments. Therefore, techniques for drafting closely fitting men's upper torso garments such as suit coats and vests are considered as well as sleeve cutting methods. Drafting systems for shirts (loosely fitting garments requiring no special cutting or fitting skill) and for trousers are excluded.

Several categories of patents related to drafting men's and women's garments are also excluded. Not considered are methods limited to the cutting or applying of trim, collars, cuffs, or lapels. There is no inclusion of methods for marking fabric from a pattern prior to cutting, if the patentee did not claim a technique for making the pattern as well. Also outside the scope of this study are methods

limited to perforating, notching, printing, or marking seam allowances or instructions on paper patterns.

The patents are listed in chronological order. This arrangement also places the patents issued after 1836 in numerical order by patent number. There are two kinds of exceptions to this post-1836 chronological-numerical order. A separate numbering system preceded by "AI" was established by the Patent Office for "Additional Improvements" granted on earlier patents. Another system preceded by "RE" designated "Reissued" patents. These two kinds of patent actions are listed within the chronological order. The original patent number is shown in brackets below the AI or RE series number.

In December 1836 a fire destroyed most of the patent records. Patents "restored" by the patentees were numbered on an independent system identified by the suffix "X". No numbers were assigned to the unrestored patents. The data for the lost patents have been obtained from Edmund Burke's 1847 index, *List of Patents, Inventions and Designs Issued by the United States from 1790 to 1847*.

A patentee could assign all or part of his patent rights to an individual or firm. Assignees of particular interest are listed beneath the patentees' names. These assignees include authors of drafting system instruction booklets, patentees or copatentees for other patents, and individuals assigned a patent by other patentees. Firms assigned patents are also indicated when the company could have had a role in applying or marketing the invention.

The asterisks preceding certain patentees, copatentees, or assignees designate individuals who are also listed in Appendix I as the author, coauthor, editor, or publisher of an instruction book or trade periodical.

Each patent for which there are extant specifications is annotated with an abbreviation (M, W, C) indicating the kinds of apparel the patented invention could draft (men's, women's, or children's). A question mark is used with an abbreviation when the apparel cannot be positively identified. "U" indicates patents that neither specify nor contain internal evidence suggesting the kinds of garments to be cut.

<i>U.S. Patent</i>	<i>Patentee</i>	<i>Residence</i>	<i>Title</i>	<i>Clothing type</i>
(16 Jun 1821)	Ward, Allen	Alabama (Huntsville)	Cutting Garments	
(8 Feb 1822)	Kenrick, Charles	New York	Art of Tailoring	
(18 Aug 1823)	Madison, Otis	New York (Troy)	Ruler for Cutting Out Garments	
(6 Nov 1823)	Campbell, Ethan	Pennsylvania (Philadelphia)	Cutting Garments	
(15 Mar 1826)	Severson, Stephen	Maryland (Baltimore)	Marking Out and Cutting Garments	
(5 Apr 1826)	Ross, Greenberry	Kentucky (Carlisle)	Art of Tailoring	
(10 Jul 1826)	Starr, N. B.	Pennsylvania (Philadelphia)	Scale for Draughting Garments	
4,687X (28 Feb 1827)	*Wilson, James G.	New York (New York)	Square for Cutting Garments	M
(23 Oct 1827)	Allen, William W.	Pennsylvania (Philadelphia)	Draughting and Cutting Garments	
5,234X (11 Oct 1828)	Ward, Allen	Pennsylvania (Philadelphia)	Tailoring	M
5,327X (9 Jan 1829)	Lemont, Levi Peterson	Maine (Bath)	Tailor's Measure	M
(3 Sep 1831)	Pudney, John	New York (Waterford)	Measuring and Cutting Garments	
6,807X (22 Oct 1831)	Henderson, James, and Cooper K. Watson	Ohio (Zanesville)	Tailors' Measure	M
7,112X (7 Jun 1832)	Wiswell, Andrew	New Hampshire (Exeter)	Square	M
(16 Apr 1833)	Mendenhall, James	Pennsylvania (Westchester)	Measuring for Garments	
(20 Apr 1833)	Bacon, G. W. M.	New York (New York)	Measuring for Garments	
7,566X (3 May 1833)	*Wilson, James G.	New York (New York)	Tailors' Measure	M

<i>U.S. Patent</i>	<i>Patentee</i>	<i>Residence</i>	<i>Title</i>	<i>Clothing type</i>
7,591X (22 May 1833)	Williams, Daniel	New York (New York)	Improvement in the Art of Tailoring	M
(5 Aug 1833)	Beard, George, Jr.	Pennsylvania (W. Whiteland)	Marking Out and Cutting Garments	
7,817X (19 Nov 1833)	Lewis, Benjamin J.	Ohio (Mount Vernon)	Tailoring	M
7,962X (18 Jan 1834)	Chappell, James H.	Ohio (Chillicothe)	Tailoring	M
(7 Jan 1835)	Ward, Allen	Pennsylvania (Philadelphia)	Measuring and Marking Out Coats	
9,110X (18 Sep 1835)	Rockafellow, John S.	New Jersey (Flemington)	Tailor's Measure	M
9,219X (31 Oct 1835)	Fairchild, Frederick A.	Georgia (Columbus)	Tailor's Measure	M
9,860X (1 Jul 1836)	Zwisler, James, Jr.	Maryland (Hagerstown)	Tailoring	M
179 (26 Apr 1837)	Bishop, William C.	New York (Ovid)	Geometrical Transfer Measurer for Measuring and Drafting Preparatory to Cutting Coats, Vests, & c.	M
256 (11 Jul 1837)	Wiswell, Andrew	New Hampshire (Exeter)	Tailoring	M
283 (17 Jul 1837)	Sherman, Amos	New Jersey (Newark)	System of Tailoring	M
415 (28 Sep 1837)	Ward, Allen	Pennsylvania (Moyamensing)	Draughting Forepart of Coats	M
435 (23 Oct 1837)	Allen, William W.	Pennsylvania (Philadelphia)	Mode of Measuring, Drafting and Cutting Out Garments	M
539 (26 Dec 1837)	Barber, Erastus	Massachusetts (Boston)	Standard Measurer for Taking Measure for Coats	M
574 (20 Jan 1838)	Kahler, William, and Charles	Pennsylvania (Bloomsburg)	Art of Measuring and Cutting Garments	M
1,113 (30 Mar 1839)	Axford, Edward I.	Pennsylvania (Philadelphia)	Tailor's Drafting Instrument for Drafting Garments	M
1,119 (10 Apr 1839)	Wiswell, William M.	Maine (Portland)	Tailoring	M
1,136 (26 Apr 1839)	Williams, Daniel	New York (New York)	Instrument for Measuring the Human Body Preparatory to Cutting Garments	M
RE11 (31 Aug 1839)	Williams, Daniel	New York (New York)	Tailors' Measure	M
[7,591X] 1,406 (12 Nov 1839)	Barnett, John P., and Francis Story	New York (Catskill)	Tailor's Measuring Instrument	M
AI31 (18 Feb 1840)	Williams, Daniel	New York (New York)	Tailor's Measure	M
[1,136] 1,556 (18 Apr 1840)	Lemmond, William J.	South Carolina (Lancasterville)	Tailor's Measuring Instrument	M
1,557 (18 Apr 1840)	Hendryx, Isaiah J.	New York (Troy)	Mode of Measuring and Drafting Garments	M
1,584 (8 May 1840)	Dame, Richard	New Hampshire (Hanover)	Construction of Tailors' Measures	M
1,880 (5 Dec 1840)	Tilden, Thomas E.	Maryland (Baltimore)	Mode of Measuring the Human Body for the Drafting and Cutting of Coats	M
1,944 (23 Jan 1841)	*Tentler, Aaron A.	Pennsylvania (Philadelphia)	Manner of Taking Measures and Drafting for the Cutting Out of Ladies' Dresses Including Habits,	W

<i>U.S. Patent</i>	<i>Patentee</i>	<i>Residence</i>	<i>Title</i>	<i>Clothing type</i>
			Cloaks, and Other Similar Articles	
2,106 (29 May 1841)	Miller, Lyman B., and Ellery	New York (Middletown)	Tailor's Measure	M
2,341 (10 Nov 1841)	*Flenner, Lewis	Pennsylvania (Philadelphia Co.)	Tailor's Instrument and the Mode of Measuring Garments	M
2,450 (7 Feb 1842)	Brundage, Henry C.	New York (Middletown)	Construction of Instruments for Measuring Garments	M
2,590 (29 Apr 1842)	Seger, Hiram	Georgia (Macon)	Tailoring	M
2,640 (26 May 1842)	Veret, Peter F. L.	Georgia (Warrentown)	Instrument for Measuring Garments	M
2,730 (20 Jul 1842)	Knowland, Joseph, and Jacob F.	Kentucky (Brownsboro)	Instrument for Measuring Garments	M
3,024 (30 Mar 1843)	Oliver, Thomas	New York (New York)	Tailor's Measure	M
3,130 (14 Jun 1843)	Pendell, David L.	New York (Gilboa)	Measuring and Cutting Garments	M
3,160 (8 Jul 1843)	Sipperly, David N.	New York (Troy)	Cutting Garments	M
3,161 (8 Jul 1843)	Morey, Cyrus, and David Hummer	Ohio (McArthurstown)	Tailor's Measure	M
3,286 (28 Sep 1843)	Eckler, George, and S. X. Ball	New York (Flint Creek)	Tailor's Measure	M
3,522 (4 Apr 1844)	Richardson, Samuel S.	Maine (Baldwin)	Fitting Ladies' Dresses	W
3,603 (30 May 1844)	Isham, Henry	Vermont (Montpelier)	Tailor's Measure	M
3,820 (9 Nov 1844)	Combs, John P.	New Jersey (Trenton)	Tailor's Measure	M
4,083 (20 Jun 1845)	Stillwell, S. B.	New York (Brooklyn)	Tailoring	M
4,294 (29 Nov 1845)	Bogardus, Abraham A.	New York (Newburg)	Tailor's Measure	M
4,327 (26 Dec 1845)	Ward, Allen	Maryland (Baltimore)	Tailor's Measure	M
4,367 (28 Jan 1846)	Seger, Hiram	Georgia (Macon)	Cutting Ladies' Dresses	W
4,477 (25 Apr 1846)	Donges, Henry	Pennsylvania (Newport)	Improvement in Tailors' Measures	M
4,596 (27 Jun 1846)	Kile, Conrad	Ohio (Nashville)	Tailor's Measure	M
4,742 (5 Sep 1846)	Acton, William R.	Virginia (Richmond)	Tailor's Measure	M
4,831 (29 Oct 1846)	Martin, Benjamin G.	Virginia (Richmond)	Tailor's Measure	M
4,923 (7 Jan 1847)	Simril, Miles G.	South Carolina (Chesterville)	Tailor's Measure	M
4,975 (20 Feb 1847)	Watt, Thomas	Ohio (Hubbard Township)	Tailor's Measure	M
5,635 (13 Jun 1848)	Lucas, Charles	Virginia (Charlottesville)	Drafting and Measuring Garments	M
6,286 (10 Apr 1849)	Carpenter, John	Pennsylvania (Uniontown)	Tailor's Measure	M
7,402 (8 May 1850)	Stoker, Amos	New York (Ogdensburg)	Tailor's Measure	M
A195 (3 Sep 1850)	Stoker, Amos	New York (Ogdensburg)	Tailors' Measure	M
[7,402]				
7,641 (10 Sep 1850)	Allen, William W.	New Jersey (Bordentown)	Tailor's Measure	M
8,566 (2 Dec 1851)	Maginnis, James	New York (Lockport)	Tailor's Measure	M
8,600 (16 Dec 1851)	Virtue, Edward	Pennsylvania (Philadelphia)	Tailor's Measure	M
8,895 (20 Apr 1852)	Wells, William T.	Tennessee (Shelbyville)	Tailoring	M
10,779 (18 Apr 1854)	Rowlands, Mosses [sic] T.	Pennsylvania (Pittstown Ferry)	Tailor's Measure	M
11,339 (18 Jul 1854)	Spilman, Peter	Virginia (Richmond)	Apparatus for Laying Off the Scye in Cutting Garments	M

<i>U.S. Patent</i>	<i>Patentee</i>	<i>Residence</i>	<i>Title</i>	<i>Clothing type</i>
11,866 (31 Oct 1854)	Krider, John M.	Virginia (Newtown Stephensburg)	Tailor's Measuring Instrument	M
11,868 (31 Oct 1854)	Lillibridge, Warren, and Charles F.	Ohio (Zanesville)	Tailor's Measure	
15,824 (30 Sep 1856)	Stocker, Amos	New York (Rome)	Tailor's Measure	M
16,472 (27 Jan 1857)	Derby, Lyman	New York (New York)	Tailor's Measure	M
18,958 (29 Dec 1857)	Corley, Simeon	South Carolina (Lexington)	Instrument for Drafting Coats	M
19,271 (2 Feb 1858)	Weston, James M.	New York (Chesterfield)	Improvement in Machines for Draughting Garments	W
20,826 (6 Jul 1858)	Stace, W. R.	New York (Rochester)	Tailor's Measure	M
35,226 (13 May 1862)	Fowler, Henry A.	New York (Afton)	Instrument for Drafting Ladies' Dresses	W
38,757 (2 Jun 1863)	Osler, H.	Pennsylvania (Philadelphia)	Tailoring	M
45,780 (3 Jan 1865)	West, J. B.	New York (New York)	Tailoring	M
46,409 (14 Feb 1865)	*Turner, M. M.	Ohio (North Fairfield)	Chart for Cutting Dresses	W
48,644 (11 Jul 1865)	Beard, G.	Ohio (Salineville)	Tailor's Measure	M
52,566 (13 Feb 1866)	Harley, G.W.T.	Maryland (Frederick)	Tailor's Measure	M
52,950 (6 Mar 1866)	Beard, George	Ohio (Salineville)	Tailor's Measure	M
56,383 (17 Jul 1866)	Dittenhafer, Catherine	Ohio (Canton)	System of Cutting Dresses	W
56,892 (7 Aug 1866)	Brigham, S. O.	California (San Francisco)	Improvement in Body- Conformators	W
57,254 (14 Aug 1866)	La Ment, P. A.	New York (New York)	Dress Fitting Apparatus	W
57,837 (4 Sep 1866)	Carpenter, H. M.	Michigan (Grand Rapids)	Chart for Cutting Dresses	W
60,028 (27 Nov 1866)	McDonald, Curran E.	Indiana (Indianapolis)	Tailoring—Improvement in Apparatus for Obtaining the Measures for Ladies' Dresses	W
61,349 (22 Jan 1867)	Mengel, Herrmann	Pennsylvania (Philadelphia)	Improvement in Instruments for Guiding Tailors in Cutting Out Coats and Vests	M
67,774 (13 Aug 1867)	Krider, J. M.	Virginia (Madison Court-House)	Improvement in Tailors' Measuring Instruments	M
70,621 (5 Nov 1867)	Rosen, E.	New York (New York)	Improvement in Conformators	M
71,192 (19 Nov 1867)	Malnight, John	Michigan (Grass Lake)	Measuring and Cutting Out Dresses	W
71,520 (26 Nov 1867)	Lemley, Jacob, Jr.	Virginia (Newtown)	Improvement in Means for Measuring and Laying Out Garments	M
72,432 (17 Dec 1867)	Vandoren, Theodore, Sr.	Washington, D. C.	Improvement in Taking the Form and Measure of Gentlemen to Cut Coats and Vests	M
76,128 (31 Mar 1868)	Windle, Susan R.	Ohio (Chillicothe)	Improvement of Measures for Cutting Dresses	W
77,704 (5 May 1868)	Mengel, Herman [sic]	Pennsylvania (Philadelphia)	Measuring and Laying Out Garments	M
78,338 (26 May 1868)	Tierney, D.	New York (New York)	Tailor's Square	M
78,726 (9 Jun 1868)	Dolan, Patrick W.	New Jersey (Jersey City)	Improvement in Tailors' Rules	M
79,083 (23 Jun 1868)	Sinnott, W., and J. McNaughton	New York (Brooklyn)	Improvements in Tailor's Measure	M
86,829 (9 Feb 1869)	Flores, Alonzo Hernandez	New York (New York)	Improvement in the Compound Scale for Tailors' Use	M

<i>U.S. Patent</i>	<i>Patentee</i>	<i>Residence</i>	<i>Title</i>	<i>Clothing type</i>
89,091 (20 Apr 1869)	Sweezy, George P.	New York (Riverhead)	Improvement in Patterns for Measuring, Laying Out, and Cutting Garments	M
89,735 (4 May 1869)	Burrows, H. M.	New York (Norwich)	Cutting and Fitting Ladies' Dresses	W
90,363 (25 May 1869)	*Jackson, Louisa L.	Indiana (Richmond)	Ladies' Dress Guide	W
91,642 (22 Jun 1869)	Lent, J. M.	New York (Schuyler's Lake)	Improvements in Patterns for Measuring and Cutting-Out Dress-Waists	W
92,873 (20 Jul 1869)	Mueller, Fritz, and Hermann Koeller	New York (New York)	Tailors' Measuring Apparatus	M
97,672 (7 Dec 1869)	Michael, W. M.	Pennsylvania (Indiana)	Improvement in Patterns for Laying Out Garments	M
98,618 (4 Jan 1870)	Ordway, Ira J	New York (West Edmeston)	Improvement in Devices for Measuring and Laying Out Garments	M
101,052 (22 Mar 1870)	Shawcross, Samuel	Illinois (Freeport)	Improvement in Adjustable Garment-Patterns	M
101,390 (29 Mar 1870)	Smith, William E.	Illinois (Chicago)	Model for Cutting Dresses	W
102,505 (3 May 1870)	Cummins, W. G.	Tennessee (District No. 10)	Tailor's Measure	M
103,487 (24 May 1870)	Moses, Isaac	New York (New York)	Improvement in Tailors' Measures	M
105,355 (12 Jul 1870)	Miller, Jonathan J.	Pennsylvania (McAlvey's Fort)	Cutting Out Garments	M
105,486 (19 Jul 1870)	Palmer, Moses, and E. Willoughby Anderson	Massachusetts (Boston) Washington, D. C.	Improved Pattern for Measuring the Body for Garments	M
107,068 (6 Sep 1870)	Lette, Ursula L.	New York (Owego)	Instrument for Draughting Garments	W
109,076 (8 Nov 1870)	Sweezy, George P.	New York (Riverhead)	Improvement in Adjustable Coat-Patterns	M
110,097 (13 Dec 1870)	Wetmore, Fannie	Illinois (Chicago)	Pattern for Measuring and Laying Out Garments	W
111,236 (24 Jan 1871)	*Moschowitz, Schamu	New York (New York)	Improvement in Body-Lining for Ladies' Dresses	W
112,024 (21 Feb 1871)	*Ewing, Sarah C.	Indiana (Indianapolis)	Pattern for Cutting Garments	W C
115,180 (23 May 1871)	DuBois, Ithamar	New York (Brooklyn)	Improvement in Tailors' Measures	M
121,642 (5 Dec 1871)	Mayer, William H.	New Jersey (Newark)	Improvement in Apparatus for Fitting and Laying Out Garments	M
123,170 (30 Jan 1872)	Harley, George W. T.	Maryland (Frederick)	Improvement in Tailors' Measures	M
124,602 (12 Mar 1872)	Matheson, Hugh	Canada (Toronto)	Improvement in Tailors' Scales	M
126,825 (14 May 1872)	Millwee, Sarah A.	South Carolina (Greenwood)	Patterns for Cutting Garments	W
129,603 (16 Jul 1872)	Schreckengaust, Julia A.	Ohio (Chillicothe)	System of Laying Out Garments	W
130,161 (6 Aug 1872)	Smith, John	Ohio (Burton)	Device for Taking Tailors' Measurements	M
137,967 (15 Apr 1873)	Smith, Mrs. E. P.	Illinois (Chicago)	Dress Patterns	W
140,507 (1 Jul 1873)	Johnston, J. R.	Canada (Montreal)	Improvement in Tailor's Measures	M

<i>U.S. Patent</i>	<i>Patentee</i>	<i>Residence</i>	<i>Title</i>	<i>Clothing type</i>
143,556 (14 Oct 1873)	Beaudry, Joseph	Canada (Montreal)	Improvement in Tailors' Measures	M
150,853 (12 May 1874)	Falk, Adolph, and J. Finkenstein	New York (New York)	Tailor's Measure	M
155,073 (15 Sep 1874)	Eager, George R.	Massachusetts (Boston)	Improvement in Tables for Cloth-Cutting	M
155,287 (22 Sep 1874)	Carpenter, Mary F.	Minnesota (Northfield)	Improvement in Dress-Pattern Charts	W
155,322 (22 Sep 1874)	Lemley, Jacob	Virginia (Newtown)	Improvement in Guides for Cutting Patterns	M
156,086 (20 Oct 1874)	Henville, Amanda M.	Massachusetts (Chelsea)	Dress-Charts	W
158,194 (29 Dec 1874)	Bauer, Zachaeus	Missouri (St. Louis)	Devices of Laying Out Vests	M
163,911 (1 Jun 1875)	Bauer, Zachaeus	Missouri (St. Louis)	Apparatus for Laying Out Coat-Patterns	M
164,343 (8 Jun 1875)	Tiffany, G. E.	Indiana (Indianapolis)	Improvement in Tailors' Devices for Laying Out Garments	M
164,943 (29 Jun 1875)	Smith, F. B.	Washington, D. C.	Tailors' Measures	M
165,026 (29 Jun 1875)	Richey, Albert H.	Pennsylvania (Lebanon)	Tailors' Measuring Apparatus	M
165,383 (6 Jul 1875)	Tilney, William DeCaux	Indiana (Crawfordsville)	Tailors' Measures	M
166,257 (3 Aug 1875)	Charch, John S.	Ohio (Dayton)	Tailors' Measures	M
167,957 (21 Sep 1875)	Ullrich, Friedrich H.	New York (New York)	Tailors' Measures	M
168,936 (19 Oct 1875)	Ten Eyck, M. C.	Minnesota (St. Paul)	Tailor's Drafting Apparatus	M
169,402 (2 Nov 1875)	Bellamy, John	New York (New York)	Tailor's Apparatus for Drafting Patterns	M
169,468 (2 Nov 1875)	Nichols, James H.	Massachusetts (Boston)	Tailor's Patterns	M
169,564 (2 Nov 1875)	Melcher, Michael A., and Lewis A.	Michigan (Constantine)	Pattern-Charts for Drafting Patterns	M
169,744 (9 Nov 1875)	Ullrich, Friedrich H.	New York (New York)	Improvement in Apparatus Drafting Tailors' Patterns	M
170,157 (23 Nov 1875)	Charch, John S.	Ohio (Dayton)	Tailors' Coat-Measurers	M
174,443 (7 Mar 1876)	Rondel, Pierre	France (Paris)	Tailor's Drafting Apparatus	M
177,702 (23 May 1876)	Ender, Richard	Maryland (Baltimore)	Tailors' Measures	M
179,046 (20 Jun 1876)	Nichols, J. H.	Massachusetts (Boston)	Method and Apparatus for Laying Out Coat Patterns	M
179,808 (11 Jul 1876)	McLellan, Robert G.	Canada (Woodstock, Ontario)	Tailors' Measures	M
182,968 (3 Oct 1876)	Steiner, Carl A.	Missouri (St. Louis)	Apparatus for Drafting Patterns	M
185,352 (12 Dec 1876)	Rich, Ellen P.	Massachusetts (Boston)	Patterns for Garments	U
185,412 (19 Dec 1876)	Venner, William	New York (Hamburg)	Tailors' Measures	M
185,842 (2 Jan 1877)	Subera, Harry W.	Iowa (Lyons City)	Pattern Chart	W C
187,587 (20 Feb 1877)	Bixby, Lucy J.	New York (Binghamton)	Improvement in Pattern-Charts for Cutting Garments	W C
188,896 (27 Mar 1877)	Harrison, Margaret	Illinois (Rock Island)	Improvement in Dress Charts	W C
190,686 (15 May 1877)	Lasar, Godfrey H.	Missouri (St. Louis)	Improvement in Tailors' Measures	M
194,086 (14 Aug 1877)	*Griffin, Caleb Henry	Massachusetts (Lynn)	Instruments for Drafting Patterns	W
195,308 (18 Sep 1877)	Reeves, Edward H.	Maine (West Farmington)	Pattern Charts for Cutting Garments	U

<i>U.S. Patent</i>	<i>Patentee</i>	<i>Residence</i>	<i>Title</i>	<i>Clothing type</i>
195,332 (18 Sep 1877)	Bauer, Zachaeus	Missouri (St. Louis)	Apparatus for Drafting Patterns for Dresses and Coats	M W
195,925 (9 Oct 1877)	*Griffin, Caleb H.	Massachusetts (Malden)	Dress-Makers' Squares	W
195,926 (9 Oct 1877)	*Griffin, Caleb Henry	Massachusetts (Lynn)	Improvement of Drafting Apparatus for Ladies' Dresses	W
196,615 (30 Oct 1877)	Wuerfel, Mrs. Julia	Michigan (Sheboygan)	Dress-Pattern Chart	W
200,234 (12 Feb 1878)	Webster, Ursula L.	Connecticut (New Haven)	Adjustable Patterns for Garments	W
200,779 (26 Feb 1878)	Thompson, Ethan O.	Pennsylvania (Philadelphia)	Tailors' Measuring-Tools	M
204,120 (21 May 1878)	Wingate, Julia P.	Massachusetts (Boston)	Dress Makers' Square	W
206,315 (23 Jul 1878)	*Griffin, Caleb H.	Massachusetts (Malden)	Drafting Square for Garments	W
207,880 (10 Sep 1878)	Lingen, Hermann	West Virginia (Wheeling)	Improvement in Measuring-Jackets	M
209,111 (22 Oct 1878)	*Cornwell, Willett	Pennsylvania (Philadelphia)	Improvement in Dress-Charts	W
212,587 (25 Feb 1879)	Boone, Thomas R.	New York (Rochester)	Tailors' Measures	M
213,436 (18 Mar 1879)	*McDowell, Albert	Pennsylvania (Philadelphia)	Adjustable Pattern-Plates for Drafting Garments	W
215,310 (13 May 1879)	Adams, Margaret E.	Indiana (South Bend)	Dress-Maker's Chart	W
215,613 (20 May 1879)	Heaford, Edwin V.	Kentucky (Covington)	Adjustable Pattern-Plates for Drafting Garments	W
216,257 (10 Jun 1879)	Brooke, John A.	Ohio (Cincinnati)	Pattern for Garments	M
223,543 (13 Jan 1880)	Riley, Marsha E.	Oregon (Harrisburg)	Dress-Makers' Chart	W
224,832 (24 Feb 1880)	Linck, Emil J.	Maryland (Baltimore)	Pattern Chart for Drafting Garments	W
225,678 (16 Mar 1880)	Woolson, H. H.	Vermont (Montpelier)	Tailor's Measuring Device	M
226,605 (20 Apr 1880)	Emery, John A.	Massachusetts (Boston)	Dress-Maker's Squares	W
228,527 (8 Jun 1880)	*Griffin, Caleb H.	Massachusetts (Boston)	Dressmaker's Chart	W
229,088 (22 Jun 1880)	Bruce, Mary E.	New York (New York)	Pattern Charts for Use in Cutting Dresses	W
233,441 (19 Oct 1880)	Scanlan, John	Illinois (Chicago)	Tailor's Measuring Device	M
234,273 (9 Nov 1880)	*Griffin, Caleb H.	Massachusetts (Boston)	Dress-Maker's Square	W C
234,821 (23 Nov 1880)	*Taylor, Mary A.	New York (New York)	Sleeve Pattern	W
235,776 (21 Dec 1880)	*Kellogg, F. J.	Michigan (Flint)	Apparatus for Drafting Patterns	W
242,240 (31 May 1881)	Wickersham, Angeline P.	Pennsylvania (Philadelphia)	Pattern Marker	W
242,542 (7 Jun 1881)	Kinker, Ellen K.	Oregon (Corvallis)	Dress-Chart	W
242,696 (7 Jun 1881)	Robinson, Lucie	New York (Oswego)	Pattern Chart and Square for Measuring and Drafting Dresses	W
245,654 (16 Aug 1881)	Peyser, Abraham	Massachusetts (Gloucester)	Coat	M
245,717 (16 Aug 1881)	Hartung, C.	Pennsylvania (Enon Valley)	Tailor's Measure	M
246,536 (30 Aug 1881)	*Moschowitz, Herman	New York (New York)	Goods for Dress-Linings Having Pattern Printed Thereon	W
247,339 (20 Sep 1881)	*Goldsberry, William H.	Iowa (Nevada)	Tailor's Square	M
251,963 (3 Jan 1882)	Start, May A.	Iowa (Cherokee)	Chart for Drafting Ladies' and Children's Garments	W C
252,388 (17 Jan 1882)	Linck, E. J.	Maryland (Baltimore)	Chart for Drafting Garments	M

<i>U.S. Patent</i>	<i>Patentee</i>	<i>Residence</i>	<i>Title</i>	<i>Clothing type</i>
252,507 (17 Jan 1882)	*Palmer, E. Ellsworth	Wisconsin (Baraboo)	Dress-Chart	W
254,074 (21 Feb 1882)	Walker, Kate	Indiana (Indianapolis)	Dress Cutting and Fitting Mold	W
259,162 (6 Jun 1882)	*Jackson, H. Ayers	Iowa (Des Moines)	Method of and Means for Drafting and Cutting Clothing	W
263,779 (5 Sep 1882)	*Ganzhorn, William	Massachusetts (Boston)	Dress-Maker's Measure	W
265,628 (10 Oct 1882)	Parkhill, Joseph H.	Iowa (Mount Pleasant)	Tailor's Measure	M
266,137 (17 Oct 1882)	Groves, John Larue	New Jersey (Elizabeth)	Pattern-Draft	M
266,919 (31 Oct 1882)	Taylor, David Jackson	Iowa (Grinnell)	Dress Chart	W C
269,652 (26 Dec 1882)	Ferguson, Mary A.	Indiana (Indianapolis)	Dress Maker's Chart	W C
270,933 (23 Jan 1883)	Chandler, Mary B.	New Hampshire (Concord)	Instrument for Drafting Patterns	W
272,204 (13 Feb 1883)	*Buddington, Frank E.	Minnesota (Stillwater)	Dressmakers' Measure for Cutting Dresses and Other Articles of Clothing	W
272,611 (20 Feb 1883)	Abrahart, William	Ohio (Cincinnati)	Apparatus for Measuring and Cutting Out Garments	M
276,032 (17 Apr 1883)	Hamilton, Doria C.	New York (New York)	Dress Maker's Measure	W
277,453 (15 May 1883)	Brolly, Hugh	New York (Albany)	Tailor's Measure	M
278,180 (22 May 1883)	Propach, Henry	New York (New York)	Dress Chart	W
279,979 (26 Jun 1883)	*Phelps, Brigham T.	Vermont (Bellows Falls)	Dress Square	W
281,056 (10 Jul 1883)	Griswold, Alice L. B.	Pennsylvania (Philadelphia)	Adjustable Pattern for Garments	W
281,530 (17 Jul 1883)	Lennards, Nicholas	Illinois (Harvard)	Measuring Device for Tailors' & c.	M
281,666 (24 Jul 1883)	Call, Libbie A.	Wisconsin (Oshkosh)	Dress Chart	W
282,670 (7 Aug 1883)	Rugland, Samuel C.	California (San Francisco)	Tailor's Measure	M
282,842 (7 Aug 1883)	*Byrnes, T. W.	Wisconsin (Manitowoc)	Apparatus for Drafting Garments	M W
283,638 (21 Aug 1883)	Monjou, Jean	France (Paris)	Device for Measuring and Fitting Dresses	W
284,783 (11 Sep 1883)	*Wallace, William	California (Oakland)	Dress Maker's Rule	W
287,731 (30 Oct 1883)	Schafer, May S.	Illinois (Chicago)	Pattern for Cutting Dress Patterns	W
296,426 (8 Apr 1884)	McCartin, William J.	Missouri (St. Louis)	Coat-Pattern	M
297,570 (29 Apr 1884)	Chenivresse, Jean M. Claudius	France (Bourg St. Andeol)	Pattern for Undergarments	W
299,383 (27 May 1884)	Hand, John S.	California (San Francisco)	Tailor's Measuring Device	M
305,501 (23 Sep 1884)	Bechtel, John R.	Pennsylvania (Reading)	Tailor's Measure	M
305,849 (30 Sep 1884)	Rugland, Samuel C.	California (San Francisco)	Tailor's Square	M
307,664 (4 Nov 1884)	*Livingston, James W.	New York (New York)	Method and Apparatus for Cutting Patterns for Dresses	W
310,297 (6 Jan 1885)	*McDowell, Albert	New York (New York)	Adjustable Pattern for Drafting Dresses	W
310,666 (13 Jan 1885)	Gates, George Shattuck	Massachusetts (Athol)	Apparatus for Drafting the Arm-Size of Garments	M
312,211 (10 Feb 1885)	Lingen, Hermann	West Virginia (Wheeling)	Measuring-Jacket	M
314,526 (24 Mar 1885)	Frega, G.	Pennsylvania (Philadelphia)	Mode of Cutting and Fitting Garments	M

<i>U.S. Patent</i>	<i>Patentee</i>	<i>Residence</i>	<i>Title</i>	<i>Clothing type</i>
317,332 (5 May 1885)	Freeman, Ann M.	Missouri (Kansas City)	Dress Cutting Rule	W
320,496 (23 Jun 1885)	Pollock, William Bloomer	Pennsylvania (Philadelphia)	Garment Measuring and Fitting Device	W
321,986 (14 Jul 1885)	*Lewis, Sophronia T.	New York (Watertown)	Dress Chart	W
322,402 (14 Jul 1885)	Tierney, Catharine A.	Illinois (Chicago)	Guide for Use in Cutting Garments	W
324,022 (11 Aug 1885)	Hand, John S.	California (San Francisco)	Tailor's Measuring Device	M
324,472 (18 Aug 1885)	Jacobsen, Martha	Iowa (Lyons)	Adjustable Pattern for Drafting Garments	W
325,216 (25 Aug 1885)	Northen, Mary E.	Texas (Lanier)	Dress Chart	M W C
325,358 (1 Sep 1885)	*Olson, Jennie S.	Minnesota (Houston)	Tailor's Chart for Cutting Garments	W
325,409 (1 Sep 1885)	Hendrick, Susan M.	New York (New York)	System and Device for Measuring Garments	U
327,172 (29 Sep 1885)	*Jackson, H. Ayers	Illinois (Chicago)	System of Measuring for Garments	M W C
327,725 (6 Oct 1885)	Schmidt, John J. G. C.	New York (New York)	Chart for Laying Out Patterns	W C
327,961 (6 Oct 1885)	*Moschcowitz, Schamu M.	New York (New York)	Combined Pattern and Fabric	M W
332,783 (22 Dec 1885)	Chambers, G. J., & E.	Illinois (Springfield)	Tailor's Measure	M
334,457 (19 Jan 1886)	McCann, James D.	Nebraska (Falls City)	Measure for Drafting Garments	W
337,016 (2 Mar 1886)	Penley, Julia	Maine (Bangor)	Dress Chart	W
341,572 (11 May 1886)	Hand, J. S.	California (San Francisco)	Tailor's Outline Measuring Device	M
342,216 (18 May 1886)	*McDowell, Albert	New York (New York)	Adjustable Pattern for Drafting Garments	W
343,859 (15 Jun 1886)	Schad, Anton	Kentucky (Louisville)	Tailor's Measure	M
347,760 (17 Aug 1886)	Frega, Giuseppe	Pennsylvania (Philadelphia)	Curve-Scriber for Tailors' Use	M
347,888 (24 Aug 1886)	Pusey, Caroline S.	Pennsylvania (Philadelphia)	Pattern for Garment	W
349,198 (14 Sep 1886)	Baker, Elvira	Indiana (Mitchell)	Dress-Maker's Chart	W
350,073 (28 Sep 1886)	*Moschcowitz, Herman	New York (New York)	Pattern for Garments	W
353,508 (30 Nov 1886)	Schumacher, Jacob	New Jersey (Camden)	Pattern Sheet	M
355,160 (28 Dec 1886)	*Gartland, Elizabeth	Pennsylvania (Philadelphia)	Chart for Drafting Garments	W
355,583 (4 Jan 1887)	Brooke, Emily	New York (Brooklyn)	Method of Fitting Garments	W
357,762 (15 Feb 1887)	*Coleman, Mary V.	Georgia (Atlanta)	Method of Cutting and Fitting Garments	W
358,903 (8 Mar 1887)	Weir, John	Ohio (Dayton)	Measuring-Jacket	M
361,292 (19 Apr 1887)	*Jackson, H. Ayers	Illinois (Chicago)	Tailor's Measure	M
362,378 (3 May 1887)	Hawkins, Thomas	California (San Francisco)	Dress-Cutting Chart	W
362,579 (10 May 1887)	Frega, Guiseppe [sic]	Pennsylvania (Philadelphia)	Tailor's Measure	M
363,237 (17 May 1887)	Hood, Eunice	Pennsylvania (Bradford)	Apparatus for Cutting Garments	U
364,620 (7 Jun 1887)	*Wuerfel, Augusta J.	Wisconsin (Milwaukee)	Tailor's Rule	W C
365,385 (28 Jun 1887)	Johnson, Frank G.	New York (Brooklyn)	Conformator	W
365,800 (5 Jul 1887)	*Davis, Myra A.	Maine (Portland)	Dress Maker's Guide	W
367,455 (2 Aug 1887)	Smith, William	Canada (Ontario)	Tailor's and Dress Maker's Square	M W C
369,080 (30 Aug 1887)	See, James W.	Ohio (Hamilton)	Dress Fitting Model	W
375,972 (3 Jan 1888)	Wilson, Josephine Sarah	California (San Jose)	Dress Chart	W

<i>U.S. Patent</i>	<i>Patentee</i>	<i>Residence</i>	<i>Title</i>	<i>Clothing type</i>
376,558 (17 Jan 1888)	Stahl, E.	Arizona Territory	Method of and Device for Fitting Garments	W
379,384 (13 Mar 1888)	Fels, F. & Simon D.	Pennsylvania (Philadelphia)	Dress Chart	W
381,563 (24 Apr 1888)	Mandelbaum, Solomon	Illinois (Chicago)	Adjustable Pattern Chart	M
383,926 (5 Jun 1888)	Wachter, Anton	Germany (Berlin)	Adjustable Device for Outlining Patterns for Garments	W
385,637 (3 Jul 1888)	Ledoux, Francis	New York (New York)	Method of Making Patterns for Garments	W
385,944 (10 Jul 1888)	Noar, F. C.	England (Lancaster)	Apparatus for Marking Out Patterns for Garments	M
389,287 (11 Sep 1888)	Christner, David C.	Pennsylvania (Philadelphia)	Method of Obtaining the Measurement of the Human Form	W
389,327 (11 Sep 1888)	Sens, Herman A.	Ohio (Cincinnati)	Tailor's Square	M
389,376 (11 Sep 1888)	Follett, Edward P.	New York (Rochester)	Chart for Drafting Sleeves of Garments	M W
389,377 (11 Sep 1888)	Follett, E[dward] P.	New York (Rochester)	Chart for Drafting Garments	W
390,291 (2 Oct 1888)	Garnier, Martin J.	Pennsylvania (Sharpsburg)	Measure for Drafting Garments	M W C
392,263 (6 Nov 1888)	Frega, Giuseppe	Pennsylvania (Philadelphia)	Tailor's Square	M
393,552 (27 Nov 1888)	Goldsmith, Edwin M.	Pennsylvania (Philadelphia)	Garment-Chart	U
394,524 (11 Dec 1888)	Tripp, Frances A.	Massachusetts (Boston)	Dress Maker's Square	W
395,566 (1 Jan 1889)	Hurdle, Rebecca	Washington, D. C.	Dress Cutter's Scale	W
396,396 (22 Jan 1889)	Faut, P.	Illinois (Wilmington)	Tailor's and Dress Maker's Square	M W
400,504 (2 Apr 1889)	Stockman, Terissa I.	Iowa (Council Bluffs)	Dress Cutter's Rule	W
403,404 (14 May 1889)	Yates, S. W.	Illinois (Wilmington)	Tailor's Square	M
405,464 (18 Jun 1889)	Cook, W.	New York (New York)	Scale Measure	M
405,614 (18 Jun 1889)	Stearns, Elvira	Rhode Island (Providence)	Garment Measuring Device and Cutting Guide	W
406,197 (2 Jul 1889)	Couteau, Jules	France (Béziers, Hérault)	Adjustable Garment-Pattern	M
408,594 (6 Aug 1889)	de Caracena, Joseph O'N.	New York (New York)	Dress Waist	W
409,184 (20 Aug 1889)	Fike, Henry P.	Indiana (Chili)	Chart for Drafting Garments	W
410,383 (3 Sep 1889)	Stahl, Edward	Arizona (Prescott)	Method of Producing Garment Patterns and Models	W
410,695 (10 Sep 1889)	Penley, Julia	Maine (Portland)	Dress Chart	W
411,686 (24 Sep 1889)	Schubert, Carl	Germany (Dresden, Saxony)	System of Laying Out Patterns for Garments	M W
419,452 (14 Jan 1890)	Johum, Francis P.	New York (Brooklyn)	Tailor's Measure	M
420,448 (4 Feb 1890)	Gothard, James	Illinois (Chicago)	Tailor's Measure	M
422,067 (25 Feb 1890)	Bernheim, Matthew	New York (New York)	Tailor's Conforming Measure	M
422,282 (25 Feb 1890)	*Baughman, Jacob S., and Melvina E.	Iowa (Burlington)	Adjustable Pattern Plate for Garments	W
430,059 (10 Jun 1890)	*Baughman, J. S., and M. E.	Iowa (Burlington)	Chart for Drafting Garments	W
431,781 (8 Jul 1890)	O'Halloran, E. E.	New Zealand (Waipawa)	Apparatus for Drafting Patterns for Garments	M
432,322 (15 Jul 1890)	Moriarty, John H.	Washington, D. C.	Adjustable Garment Pattern	M
433,203 (29 Jul 1890)	Hout, Emma M.	Maine (Lewiston)	Dress Skirt Chart	W

<i>U.S. Patent</i>	<i>Patentee</i>	<i>Residence</i>	<i>Title</i>	<i>Clothing type</i>	
433,711 (5 Aug 1890)	Berry, Ellen A.	Massachusetts (Cambridge)	Apparatus for Marking Patterns for Dress Waists		W
435,182 (26 Aug 1890)	Kellogg, Martha E.	Michigan (Battle Creek)	Tailor's Measure	M	W
435,301 (26 Aug 1890)	Hall, Martha E.	Indiana (Crawfordsville)	Device for Fitting and Drafting Garments		W
435,714 (20 Sep 1890)	Scully, Harry Francis	Illinois (Chicago)	Tailor's Measure	M	
438,607 (21 Oct 1890)	Curry, Harriet A.	South Dakota (Dakota Territory)	Adjustable Pattern for Drafting Garments		W
439,500 (28 Oct 1890)	Garcelon, Jennie Lee	Illinois (Chicago)	Dress Maker's Fitting Apparatus		W
439,747 (4 Nov 1890)	Hawley, DeWitt	New York (Rochester)	Tailor's Measure	M	
440,692 (18 Nov 1890)	*Buddington, Frank E.	Illinois (Chicago)	Adjustable Sleeve Drafting Apparatus		W
441,369 (25 Nov 1890)	Lennart, M.	Wisconsin (Milwaukee)	Adjustable Pattern for Drafting Garments		W
441,675 (2 Dec 1890)	Lewis, Richard R.	Pennsylvania (Union City)	Tailor's Measure	M	
441,684 (2 Dec 1890)	Moriarty, John H.	Washington, D. C.	Adjustable Sleeve-Pattern	M	
447,554 (3 Mar 1891)	Berry, Ellen A.	Massachusetts (Boston)	Jacket for Making Garment Patterns		W
447,932 (10 Mar 1891)	Bishe, Salvatore, and S. Bisceglia	Illinois (Chicago)	Adjustable Pattern for Drafting Garments	M	
451,247 (28 Apr 1891)	Kennedy, H. G.	Canada (Berlin)	Chart for Drafting Garments	M	
451,553 (5 May 1891)	Drummond, George	Pennsylvania (Philadelphia)	Chart for Drafting Patterns for Garments		W
451,979 (12 May 1891)	Shane, Carrie	Iowa (Vinton)	Dress Fitting Apparatus		W
452,090 (12 May 1891)	*Walkie, Jennie	Illinois (Chicago)	Tailor's Measure	W	C
453,923 (9 Jun 1891)	Stevenson, J. W.	Ohio (Ravenna)	Dress Chart		W
455,159 (30 Jun 1891)	Broadnax, John T.	Louisiana (New Orleans)	Pattern for Vests and Shirts	M	
455,338 (7 Jul 1891)	Kelly, Mark L.	Massachusetts (Boston)	Pattern for Marking Cloth		U
455,749 (14 Jul 1891)	Hood, Eunice	Illinois (Chicago)	Dress Chart		W
455,811 (14 Jul 1891)	Bisceglia, Salvatore	Illinois (Chicago)	Sleeve-Pattern	M	
456,184 (21 Jul 1891)	Wolff, Rudolph G.	Illinois (Chicago)	Tailor's Measuring Apparatus	M	
457,124 (4 Aug 1891)	Liebl, Andrew	New York (Breslow)	Tailor's Measure	M	
457,591 (11 Aug 1891)	Schafer, May S.	Illinois (Chicago)	Multiflex Dress Chart		W
458,263 (25 Aug 1891)	Venner, William G.	New York (Buffalo)	Garment Measuring Jacket		W
460,132 (29 Sep 1891)	Havender, Joseph	Massachusetts (Springfield)	Pattern for Cutting Conical Skirt Bonds		W
460,282 (29 Sep 1891)	Smith, Prudence A.	New York (New York)	Tailor's Measure		W
465,252 (15 Dec 1891)	Ericson, Lars G.	New York (New York)	Tailor's Measuring Implement	M	
466,111 (29 Dec 1891)	Amelang, Charles A.	Maryland (Baltimore)	Method of Cutting Patterns for Garments	M	
467,045 (12 Jan 1892)	Musse, Bertha	New York (New York)	Adjustable Pattern for Drafting Garments		W
470,809 (15 Mar 1892)	Long, Flora	Indiana (Fort Wayne)	Dress Maker's Square and Rule		W
479,548 (26 Jul 1892)	Blizzard, Jennie	Ohio (Ft. Recovery)	Dress Chart		W
480,036 (2 Aug 1892)	Rensen, John Henry	Pennsylvania (Philadelphia)	Tailor's Measuring Apparatus	M	
480,453 (9 Aug 1892)	Crow, Samuel G.	Canada (Toronto)	Chart for Drafting Garments	W	C
480,579 (28 Apr 1892)	Geraci, Ignatius	Maryland (Baltimore)	Tailor's Measure	M	W
482,748 (20 Sep 1892)	Mannebach, Caspar	Michigan (Detroit)	Measuring and Drafting Device for Garments		W
483,271 (27 Sep 1892)	Trochu, Athanase	France (Redon)	Tailor's Measuring Apparatus	M	

<i>U.S. Patent</i>	<i>Patentee</i>	<i>Residence</i>	<i>Title</i>	<i>Clothing type</i>
483,521 (4 Oct 1892)	Arvidson, Pier N.	Michigan (Kalamazoo)	Tailor's Measuring-Square	M
484,138 (11 Oct 1892)	Choquette, Joseph H.	Massachusetts (Fall River)	Pattern for Drafting Garments	W
486,670 (22 Nov 1892)	Gunkel, Caspar	Iowa (Jefferson)	Tailor's Measure	M
487,237 (29 Nov 1892)	Cupler, Jacob C.	Illinois (Chicago)	Adjustable Pattern for Drafting Garments	W
487,760 (13 Dec 1892)	Musse, Bertha	New York (New York)	Adjustable Pattern	W
487,801 (13 Dec 1892)	Viau, Benjamin	New York (New York)	Dress Chart	W
489,793 (10 Jan 1893)	Christiansen, S.	New York (New York)	Garment-Fitting Pattern	W
490,022 (17 Jan 1893)	Horn, Henrietta	New York (Newark)	Adjustable Pattern for Drafting Garments	W
490,606 (24 Jan 1893)	Campbell, John R.	Massachusetts (Arlington)	Measuring-Jacket	M
492,670 (28 Feb 1893)	Frenot, Louis Désiré, and Jules François Eyboulet	New Jersey (Newark)	Adjustable Pattern for Drafting Garments	M
497,165 (9 May 1893)	Cone, Abraham M.	Massachusetts (Lee)	Tailor's Measure	M
497,503 (16 May 1893)	Sipe, Thalia E.	New York (New York)	Tailor's Measure	W C
501,337 (11 Jul 1893)	Goodwin, Terence J.	New York (Syracuse)	Pattern for Drafting Sleeves	M
503,741 (22 Aug 1893)	Faestel, A. L.	Wisconsin (Milwaukee)	Tailor's Drafting Device	M
507,054 (17 Oct 1893)	Wiggins, Thomas H.	Illinois (Pecatonica)	Tailor's Measure	M
509,080 (21 Nov 1893)	Gunkel, Caspar	Iowa (Jefferson)	Tailor's Measure	M
510,364 (5 Dec 1893)	Poulin, Hedwidge	Maine (Augusta)	Dress Chart	W
510,942 (19 Dec 1893)	Start, S. S., and Mary A. S. Johnson	Minnesota (Luverne)	Garment Pattern	M W C
510,994 (19 Dec 1893)	Schafer, Theodore	Illinois (Maroa)	Extensible Measuring-Stick	M
514,063 (6 Feb 1894)	Call, Libbie A.	Wisconsin (Oshkosh)	Measure for Laying Off Dress Charts	W
514,622 (13 Feb 1894)	Horn, Henrietta	New York (Newark)	Adjustable Pattern for Drafting Garments	W
515,511 (27 Feb 1894)	Alm, Janos A.	Illinois (Chicago)	Tailor's Measure	M
516,449 (13 Mar 1894)	Ryan, Della	Michigan (Owasso)	Pattern for Drafting Garments	W
516,828 (20 Mar 1894)	Lutz, Matthäus	Germany (Stuttgart)	Pattern for Drafting Garments	W
517,079 (27 Mar 1894)	Veitch, William	Missouri (Kansas City)	Tailor's Adjustable Measure	M
518,947 (1 May 1894)	Hawley, DeWitt	New York (Rochester)	Tailor's Measuring Implement	M
519,090 (1 May 1894)	Newcomb, Abner S.	Massachusetts (Worcester)	Device for Measuring Dress Skirts	W
522,800 (10 Jul 1894)	Osse, Charles	Maryland (Baltimore)	Adjustable Garment-Pattern	M
524,966 (21 Aug 1894)	Lambright, Hamilton	Ohio (Akron)	Adjustable Garment Pattern	W
525,019 (28 Aug 1894)	Horn, Marie	Germany (Berlin)	Garment Measuring and Drafting Apparatus	W
526,378 (25 Sep 1894)	Christiansen, Simon	New York (New York)	Garment Fitting Pattern	W
526,379 (25 Sep 1894)	Christiansen, Simon	New York (New York)	Sleeve-Pattern	W
526,380 (25 Sep 1894)	Christiansen, Simon	New York (New York)	Garment Fitting Pattern	W
532,613 (15 Jan 1895)	Tucek, Marie	New York (New York)	Method of Producing Garment Patterns	W
534,347 (19 Feb 1895)	Olsen, John R.	Illinois (Chicago)	Tailor's Square	M
534,387 (19 Feb 1895)	Brown, Daniel L.	New York (New York)	Measure for Drafting Dress Skirts	W
535,378 (12 Mar 1895)	Kelley, Mary C.	Delaware (Wilmington)	Dressmaker's Measure	W

<i>U.S. Patent</i>	<i>Patentee</i>	<i>Residence</i>	<i>Title</i>	<i>Clothing type</i>		
535,843 (19 Mar 1895)	Marshall, William J.	Minnesota (Minneapolis)	Dress Chart		W	
537,127 (9 Apr 1895)	Scott, Herman W.	Massachusetts (Lynn)	Tailor's Measure	M		
537,132 (9 Apr 1895)	*Storey, James R.	Missouri (St. Louis)	Tailor's Measure			W
537,285 (9 Apr 1895)	Griffen, Stephen M.	New Jersey (Paterson)	Tailor's Measure	M		
540,985 (11 Jun 1895)	Hodges, Estell J., and Carrie R. Mathews	Georgia (Winder)	Garment Drafting Pattern		W	
541,311 (18 Jun 1895)	*Buddington, Frank E.	Illinois (Chicago)	Apparatus for Drafting Garments		W	
543,253 (23 Jul 1895)	Kantorovitz, Harris	Washington (Walla Walla)	Device for Measuring Garments	M		
545,139 (27 Aug 1895)	Start, Sampson S., and Mary A. Start Johnson	Minnesota (Luverne)	Garment Measure		W	
546,199 (10 Sep 1895)	Snyder, Charles W.	Pennsylvania (Bloomsburg)	Adjustable Pattern		W	
552,976 (14 Jan 1896)	*Storey, James R.	Missouri (St. Louis)	Tailor's Drafting-Plate	M		
554,710 (18 Feb 1896)	Moon, Edwin L.	Ohio (Columbus)	Tailor's Measure	M		
556,856 (24 Mar 1896)	Livingston, Annie	New York (New York)	Adjustable Garment Pattern		W	
558,780 (21 Apr 1896)	Crakauer, Felix	Germany (Wiesbaden)	Apparatus for Producing Patterns	M	W	
559,045 (28 Apr 1896)	Schindler, Franz	Germany (Prussia)	Tailor's Measure	M		
560,593 (19 May 1896)	Mathews, W. A.	Ohio (Gratis)	Adjustable Pattern		W	
566,158 (18 Aug 1896)	Follett, Edward P.	Minnesota (Duluth)	Tailor's Measure	M		
568,263 (22 Sep 1896)	Moccia, Raffaele	New York (New York)	Tailor's Square	M		
570,834 (3 Nov 1896)	Baasel, William	Illinois (Chicago)	Tailor's Cutting Chart	M		
570,835 (3 Nov 1896)	Baasel, William	Illinois (Chicago)	Sleeve Chart	M		
573,408 (15 Dec 1896)	Hall, Martha E.	Indiana (New Market)	Pattern or Chart		W	
579,491 (23 Mar 1897)	Meas, Augustus	New York (Niagara Falls)	Adjustable Garment- Pattern	M		
582,101 (4 May 1897)	Schell, Natalie	California (San Francisco)	Bust Form		W	
583,858 (1 Jun 1897)	Follett, Edward P.	Minnesota (Duluth)	Instrument for Drafting Garment-Patterns	M		
584,413 (15 Jun 1897)	Scott, Charles H.	Illinois (Bloomington)	Tailor's Measure	M		
586,406 (13 Jul 1897)	Vaughn, Archer	Missouri (Carrollton)	Tailor's Measure	M		
590,495 (21 Sep 1897)	Hancock, Abram O.	Louisiana (New Orleans)	Adjustable Garment Pattern		W	
593,555 (9 Nov 1897)	Van Derworp, Anna M.	Michigan (Detroit)	Dressmaker's Measure		W	
594,443 (30 Nov 1897)	Taylor, Hiram H.	New Hampshire	Pattern Drafting Device		W	
595,239 (7 Dec 1897)	Leu, Mary D.	Ohio (Wauseon)	Dress Chart		W	
599,247 (15 Feb 1898)	Ormsby, Albertha A.	Michigan (Detroit)	Adjustable Dress Chart		W	
600,050 (1 Mar 1898)	Tucek, Marie	New York (New York)	Garment Drafting Pattern		W	
602,117 (12 Apr 1898)	William, I.	Kansas (Wichita)	Dress Chart		W	
602,471 (19 Apr 1898)	Pinkham, Almeda A.	Massachusetts (North Adams)	Adjustable Skirt Pattern		W	
606,706 (5 Jul 1898)	Collins, Mary C.	Minnesota (Minneapolis)	Skirt Cutting Rule		W	
611,995 (4 Oct 1898)	Follett, Edward P.	Illinois (Chicago)	Instrument for Laying Out Gores for Skirts		W	
613,095 (25 Oct 1898)	Van Dame, J. R.	Michigan (Grand Rapids)	Tailor's Square		W	
613,988 (8 Nov 1898)	Goodhue, Melissa	New Hampshire (Keene)	System for Drafting Dresses		W	
614,703 (22 Nov 1898)	Delory, Jean Louis	France (Blois, Loir et Cher)	Adjustable Garment Chart	M		
616,493 (27 Dec 1898)	Richardson, E. M., and J. L.	Indiana (Huntington)	Combined Square and Curve for Cutting Garments	M	W	C

<i>U.S. Patent</i>	<i>Patentee</i>	<i>Residence</i>	<i>Title</i>	<i>Clothing type</i>	
618,387 (24 Jan 1899)	Van Dame, John R.	Michigan (Grand Rapids)	Sleeve Pattern	M	W
618,392 (31 Jan 1899)	*Buddington, Frank E.	Illinois (Chicago)	Adjustable Pattern Drafting Apparatus		W
622,092 (28 Mar 1899)	Tucek, Marie	New York (New York)	Chart for Drafting Garment Patterns		W
622,419 (4 Apr 1899)	Cunningham, Emma E.	Massachusetts (West Newton)	Garment Drafting Apparatus		W
622,900 (11 Apr 1899)	Nicholas, Eliza	New Jersey (Plainfield)	Measure for Drafting Dress Skirts		W
626,258 (6 Jun 1899)	White, J. H.	New York (New York)	Tailor's Square		W
626,795 (13 Jun 1899)	*Peyry, J. B.	Louisiana (New Orleans)	Garment Fitter		W
628,083 (4 Jul 1899)	*Evan, H. P.	Wisconsin (Winneconne)	Garment Cutting Scale	W	C
628,296 (4 Jul 1899)	Atwell, Fred A.	Pennsylvania (Potter)	Adjustable Garment Drafting Chart		W
628,475 (11 Jul 1899)	Kirk, Benjamin H.	Illinois (Chicago)	Tape-Measure	M	
629,025 (18 Jul 1899)	Bluthenthal, Herbert Clay	Arkansas (Pine Bluff)	Tailor's Measure	M	
632,361 (5 Sep 1899)	O'Loughlin, Robert S.	New York (Glen Falls)	Pattern for Garments		W
633,654 (26 Sep 1899)	Melick, James T.	New Jersey (Rahway)	Garment-Fitter	M	
641,411 (16 Jan 1900)	Shelton, Zelta G.	Colorado (Rockyford)	Dress-Chart		W C
646,498 (3 Apr 1900)	Leciejewski, Johann	Germany (Posen)	Tailor's Measuring Device	M	
648,023 (24 Apr 1900)	Donaldson, George MacKay	Canada (Kentville, Nova Scotia)	Adjustable Dress-Chart		W
648,714 (1 May 1900)	Taylor, Anna Bell	Indiana (Goshen)	Skirt-Stick		W
649,988 (22 May 1900)	Kohn, Samuel	Illinois (Chicago)	Garment-Measuring Apparatus		W
651,208 (5 Jun 1900)	Sebastiano, Domenico	New York (New York)	Tailor's Square		W
655,960 (14 Aug 1900)	Cunningham, Emma E.	Massachusetts (Newton)	Skirt-Measuring Device		W
658,038 (18 Sep 1900)	Frega, Giuseppe	Pennsylvania (Philadelphia)	Tailor's Measure		U
660,175 (23 Oct 1900)	*Williams, William R.	Kansas (Lawrence)	Adjustable Chart [Skirts]		W
660,397 (23 Oct 1900)	Rosenbloom, Abe N.	Massachusetts (Boston)	Tailor's Drafting Implement	M	W C
661,537 (13 Nov 1900)	Kirk, Harry D., and Walter I.	Illinois (Chicago)	Tailor's Tape-Measure		U
662,620 (27 Nov 1900)	Goff, Vina Hildebrand	Missouri (El Dorado Springs)	Dress-Cutting Measure		W
662,817 (27 Nov 1900)	Plant, John B.	Rhode Island (Pawtucket) [Residence] Maine (Biddeford) [P. O. Address]	Dress-Chart		W
664,700 (25 Dec 1900)	Wilson, Harry C.	New York (Manhattan)	Adjustable Dress-Chart		W
667,739 (12 Feb 1901)	Schierbaum, Clara	Ohio (Cleveland)	Dressmaker's Rule		W
670,762 (26 Mar 1901)	Bowman, Viola	Pennsylvania (Dubois)	Chart		W
673,579 (7 May 1901)	Kleinberger, Markus	New York (New York)	Measuring Slide-Ruler		U
674,442 (21 May 1901)	Hockersmith, Alfred P.	Illinois (Chicago)	Tailor's Measurer	M?	W
675,537 (4 Jun 1901)	*Baughman, Jacob Schrock	Iowa (Burlington)	Adjustable Chart [Skirts]		W
678,515 (16 Jul 1901)	Rencher, Dora	Utah (Salt Lake City)	Garment-Fitter		W
688,300 (10 Dec 1901)	Goodwin, Terence J.	New York (Syracuse)	Adjustable Chart		W
688,303 (10 Dec 1901)	Griffen, Stephen M.	New Jersey (Summit)	Tailor's Measure	M	
689,361 (17 Dec 1901)	Moe, Gerhard	Wisconsin (Rhineland)	Method of Taking Photographic Measurements for Tailoring Purposes	M	W?
689,685 (24 Dec 1901)	*McDowell, William	New York (New York)	Adjustable Chart		W

<i>U.S. Patent</i>	<i>Patentee</i>	<i>Residence</i>	<i>Title</i>	<i>Clothing type</i>		
690,214 (31 Dec 1901)	Wilson, Harry C.	New York (New York)	Adjustable Sleeve-Chart	W		
692,510 (4 Feb 1902)	Follett, Edward P.	Illinois (Chicago)	Garment-Fitter	W		
700,739 (27 May 1902)	Choquette, Joseph H.	Massachusetts (Fall River)	Adjustable Dress-Chart	W		
705,194 (22 Jul 1902)	Avery, Mary Lucinda	California (Oakland)	Dress-Chart [Skirts]	W		
708,506 (2 Sep 1902)	Valentine, Gustaf V.	Illinois (Chicago)	Dress-Cutting Instrument for Drafting Garments	W		
708,754 (9 Sep 1902)	Chandler, Helen S.	New Hampshire (Dover)	Adjustable Chart	W		
709,776 (23 Sep 1902)	Kelley, Mary C.	Delaware (Wilmington)	Drafting-Rule			U
710,399 (7 Oct 1902)	Adamo, Giuseppe	Pennsylvania (Philadelphia)	Tailor's Square	W		
711,479 (21 Oct 1902)	Curran, Edward James	Australia (Sydney)	Method of Drafting Garment-Patterns	m	W	c
711,611 (21 Oct 1902)	Adelberg, Abraham	New York (Rochester)	Measuring and Drafting Device for Garments	W		
716,613 (23 Dec 1902)	Anderson, Charles	Illinois (Chicago)	Garment-Fitting Device	M		
717,253 (30 Dec 1902)	*Nelson, Jonathan	Indiana (Warsaw)	Garment-Scale	M	W	C
717,284 (30 Dec 1902)	Ryan, Catherine	Canada (Ottawa)	Garment Measuring and Drafting Device	W		
718,320 (13 Jan 1903)	Curran, Edward	Illinois (Chicago)	Device for Drafting Skirt-Patterns	W		
719,924 (3 Feb 1903)	Westcott, Benjamin F.	Maryland (Baltimore)	Measuring Instrument	W		
722,221 (10 Mar 1903)	Freeman, Sarah Sophia	Nebraska (Lincoln)	Dressmaker's Ruler	W		
731,115 (16 Jun 1903)	Morgan, Lucy W.	Maine (Auburn)	Dressmaker's Guide	W		
734,279 (21 Jul 1903)	O'Donnell, Mary F., and Emma V.	New York (Syracuse)	Skirt-Pattern	W		
735,738 (11 Aug 1903)	Follett, Edward P., * assigned to Zenith Manufacturing Company	New York (Rochester)	Device for Drafting Patterns for Garments	W		
736,052 (11 Aug 1903)	Adamson, James M.	Pennsylvania (Philadelphia)	Tailor's Tape Measure			U
739,178 (15 Sep 1903)	Hillman, Otto	Missouri (St. Louis)	Garment-Drafting Chart	W		
740,172 (29 Sep 1903)	Parker, George F., and Marie E. M. Whiting	Massachusetts (Boston)	Pattern-Chart	W		
743,436 (10 Nov 1903)	Boone, Thomas R.	New York (Rochester)	Tailor's Measuring- Square	M?		
744,475 (17 Nov 1903)	Buckley, John P.	Washington, D. C.	Garment-Drafting Rule	W		C
744,826 (24 Nov 1903)	Wakefield, Ernest	Pennsylvania (Mount Pleasant)	Tailor's Attitude- Measure	M		
745,841 (1 Dec 1903)	Hilder, Henry William	England (Brighton)	Appliances for Taking Measurements for Garments			U
748,792 (5 Jan 1904)	Robbert, Jane	California (San Francisco)	Appliance for Drafting Garments	W		C
750,975 (2 Feb 1904)	Horne, Rowlan G.	Illinois (Chicago)	Tailor's Measure	M		
753,680 (1 Mar 1904)	Davis, Loyola	Nebraska (Omaha)	Skirt-Chart	W		
754,765 (15 Mar 1904)	Griffen, Stephen M.	New Jersey (Summit)	Tailor's Measure	M	W?	
758,826 (3 May 1904)	Curran, Edward James	Australia (Bathurst)	Method of Drafting Garment-Patterns	M		
760,966 (24 May 1904)	D'Alessio, Agostino	New York (Manhattan)	Measuring Device for Garments	M	W	
761,901 (7 Jun 1904)	Northen, Mary Eva	Texas (Denton)	Pattern-Chart	M	W	C
765,407 (19 Jul 1904)	Wakefield, Ernest	Pennsylvania (Mount Pleasant)	Tailor's Measure	M?	W	
765,691 (26 Jul 1904)	Ulrich, Jean	New York (New York)	Dress-Chart	W		
765,837 (26 Jul 1904)	Hirsch, Phillip O.	Nebraska (Norfolk)	Tailor's Measure	M		
777,913 (20 Dec 1904)	Obermeier, Ludwig	Germany (Munich)	Tape-Measure	M		

<i>U.S. Patent</i>	<i>Patentee</i>	<i>Residence</i>	<i>Title</i>	<i>Clothing type</i>	
782,339 (14 Feb 1905)	Hosford, Frank	Texas (Paris)	Tailor's or Dressmaker's Measuring Device	M	W
782,415 (14 Feb 1905)	Plant, Harry N.	Maine (Biddeford)	Adjustable Dress-Chart		W
787,533 (18 Apr 1905)	*McDowell, William	New York (New York)	Chart		W
790,333 (23 May 1905)	Van Dame, John R.	Michigan (Grand Rapids)	Tailor's Chart		W
790,568 (23 May 1905)	Freeman, William	New York (New York)	Printed Dress-Pattern [Skirts]		W
794,506 (11 Jul 1905)	Kaiser, George B.	Ohio (Cincinnati)	Tailor's Measuring Device		U
797,176 (15 Aug 1905)	Colosimo, Giuseppe	Washington, D. C.	Tailor's Measure or Square	M	
798,223 (29 Aug 1905)	Sole, Frank D.	New Jersey (Newark)	Tape-Measure	M	W
803,778 (7 Nov 1905)	*McDowell, William	New York (New York)	Chart for Drafting Women's Skirts		W
809,836 (9 Jan 1906)	Nordstrom, Fred	New York (New York)	Tailor's Measure	M	
811,770 (6 Feb 1906)	Freeman, William	New York (New York)	Printed Dress-Pattern		W
812,874 (20 Feb 1906)	*Phelps, Ernest Leslie	Canada (Toronto)	Garment-Designing Curve-Rule	M	W C
813,415 (27 Feb 1906)	Geraci, Ignatius	Washington, D. C.	Tailor's Measure	M	
815,467 (20 Mar 1906)	Plant, Harry N.	Maine (Biddeford)	Dress-Chart		W
819,438 (1 May 1906)	Jones, Mrs. Minnie, now by remarriage Mrs. Minnie Franklin	Colorado (Denver)	Drafting Implement		W
822,874 (5 Jun 1906)	Tight, Jennie C.	Iowa (St. Anthony)	Skirt Measurer and Pattern		W
823,738 (19 Jun 1906)	Parker, George F., and Marie E. M. Whiting	Massachusetts (Boston)	Pattern-Chart		W
824,784 (3 Jul 1906)	Goff, Vina Hildebrand, assigned to Goff Designer Company	Kansas (Iola)	Adjustable Skirt-Pattern		W
825,915 (17 Jul 1906)	Lesh, Edwin Zachariah, * and Hester A. Woolman	Mexico (Guadalajara)	Tailor's Measure	M	W C
826,651 (24 Jul 1906)	D'Elia, Louis	Washington (Seattle)	Tailor's Measuring Apparatus	M	
830,850 (11 Sep 1906)	Roland, Arthur Malaska	Hawaii (Honolulu)	Tailor's Measuring Device	M	
831,826 (25 Sep 1906)	Buccola, Joseph	Illinois (Chicago)	Dress-Chart		W
834,762 (30 Oct 1906)	Schrader, August F., and Ophelia McCullough	Iowa (Rake)	Skirt-Drafting Chart		W
843,378 (5 Feb 1907)	Waterman, Albert	New York (New York)	Marker for Bust-Forms		W
843,862 (12 Feb 1907)	Blackburn, Richard H.	New York (New York)	Chart for Drafting Garments [Skirts]		W
845,319 (26 Feb 1907)	Ricciardi, Bartolomeo	New York (New York)	Tailor's Square	M	C
847,844 (19 Mar 1907)	Stillman, Millicent M.	New York (New York)	Garment-Pattern		W
850,340 (16 Apr 1907)	Brosnahan, Michael J.	Missouri (St. Louis)	Tailor's Appliance	M	
851,279 (23 Apr 1907)	Dobbs, Edwin Eugene	Minnesota (Minneapolis)	Dress-Chart [Skirts]		W
851,374 (23 Apr 1907)	Peterson, Erick H.	Pennsylvania (Philadelphia)	Adjustable Chart	M	
851,391 (23 Apr 1907)	Anderman, Goldie L.	Illinois (Chicago)	Method of Duplicating Forms		W
852,151 (30 Apr 1907)	Ahnelt, William P.	New York (New York)	Chart for Garment-Patterns		W
852,332 (30 Apr 1907)	Laub, George M., assigned to May Manton Pattern Company	New York (New York)	Paper Pattern		W
852,771 (7 May 1907)	Christoph, Emil A.	Illinois (Chicago)	Tape-Measure	M	W
855,272 (28 May 1907)	Barnett, Jacob	New York (New York)	Tailor's Measuring Apparatus	M	
860,773 (23 Jul 1907)	Thompson, Reinard	Massachusetts (Somerville)	Tailor's Measure	M	

<i>U.S. Patent</i>	<i>Patentee</i>	<i>Residence</i>	<i>Title</i>	<i>Clothing type</i>
865,418 (10 Sep 1907)	Moe, Gerhard	Wisconsin (Ladysmith)	Background for Photographic Measurements	U
865,761 (10 Sep 1907)	Carrara, Marie Louise	Switzerland (Geneva)	Waist-Pattern	W
869,169 (22 Oct 1907)	Flint, Charles Ernest	Australia (Hobart, Tasmania)	Tape-Measure	M W
869,264 (29 Oct 1907)	Ricciardi, Bartolomeo	New York (New York)	Tailor's Tape-Measure	M W
871,814 (26 Nov 1907)	Newtown, Charles Willard	Missouri (Kansas City)	Measure	U
873,266 (10 Dec 1907)	Phoebus, Virginia A.	New York (New York)	Machine or Device to be Used in Measuring and Cutting Skirts	W
874,997 (31 Dec 1907)	Schoepl, Joseph F.	Maryland (Baltimore)	Tailor's Templet for Making Patterns	M
875,554 (31 Dec 1907)	Pelton, Marie C.	Nebraska (Beatrice)	Garment Measuring and Drafting Device	W
882,111 (17 Mar 1908)	Horeischi, Wenzel	Switzerland (Zurich)	Adjustable Chart	U
885,167 (21 Apr 1908)	Maxwell, Alice Audley	New York (New York)	Guide-Chart for Garment-Patterns	W
887,890 (19 May 1908)	Valentine, Gustaf V.	Illinois (Chicago)	Instrument for Drafting Garment-Patterns	W
890,472 (9 Jun 1908)	Truhan, Michael	Pennsylvania (Philadelphia)	Adjustable Pattern for Coats	M
890,969 (16 Jun 1908)	Dufault, John U.	Massachusetts (Spencer)	Adjustable Pattern for Garments	M
894,207 (28 Jul 1908)	Jacobson, Hamlet Peter	New York (Brooklyn)	Pattern Draft or Chart	M
899,802 (29 Sep 1908)	Pohle, Jenny	Pennsylvania (Lansdale)	Measuring Devices for Dressmakers and the Like	W
900,568 (6 Oct 1908)	Miles, Nancie E.	Indiana (Indianapolis)	Skirt-Measuring Device	W
902,704 (3 Nov 1908)	Anderson, Samuel	Massachusetts (Brockton)	Tailor's Measuring Device	M
906,524 (15 Dec 1908)	Goerigk, Franz	Germany (Berlin)	Apparatus for Taking Tailors' Measurements	M W
909,023 (5 Jan 1909)	*Ratner, Henry W.	Illinois (Chicago)	Tailor's Square	M?
909,046 (5 Jan 1909)	Woolson, Harry H.	Massachusetts (Medford)	Tailor's Indicator	M
910,203 (19 Jan 1909)	Johnson, Jennie A.	South Dakota (Huron)	Dress-Chart	M? W
911,045 (2 Feb 1909)	Johnson, Mary M.	Colorado (Denver)	Garment-Fitting Device	W
911,046 (2 Feb 1909)	Johnson, Mary M.	Colorado (Denver)	Garment-Fitting Device	W
913,408 (23 Feb 1909)	Ma Loney, Mato Fitzmaurice	Illinois (Chicago)	Tailor's Cutting-Chart	M
915,835 (23 Mar 1909)	Di Domenico, Nicola	Rhode Island (Providence)	Tailor's Measure	M W?
918,279 (13 Apr 1909)	*Carlstrom, John A., assigned to the Jno. J. Mitchell Company	New York (New York)	Tailor's Square	M
926,322 (29 Jun 1909)	Dubinsky, Moses	Pennsylvania (Philadelphia)	Pattern-Former	W
927,845 (13 Jul 1909)	Evangelista, Vincenzo	Pennsylvania (Philadelphia)	Method of Laying Out Patterns	M W
927,948 (13 Jul 1909)	Ciervo, Michael	New York (New York)	Tailor's Measure	M
928,691 (20 Jul 1909)	Peterson, Erick H., assigned to Sartorial Pattern Company	Pennsylvania (Philadelphia)	Block-Pattern for Garments	M W?
931,896 (24 Aug 1909)	Terry, Reed A.	Nebraska (Omaha)	Adjustable Chart for Dressmaking	W
932,649 (31 Aug 1909)	Tiffany, George S.	Kansas (Hutchinson)	Tailor's Measuring Device	U
933,523 (7 Sep 1909)	Bogushefsky, Moses	New York (New York)	Adjustable Pattern	M

<i>U.S. Patent</i>	<i>Patentee</i>	<i>Residence</i>	<i>Title</i>	<i>Clothing type</i>
937,214 (19 Oct 1909)	Kellogg, Martha E.	Michigan (Battle Creek)	Apparel-Cutting Apparatus	W
938,280 (26 Oct 1909)	Sexton, Edith Ray	Illinois (Chicago)	Form-Gage	W
941,936 (30 Nov 1909)	Mongelli, Giuseppe A.	Pennsylvania (Philadelphia)	Rule	M
942,338 (7 Dec 1909)	Morrison, Margaret E.	Nebraska (Bartley)	Skirt-Measurer	W
943,130 (14 Dec 1909)	Webster, Frank D.	Missouri (St. Louis)	Adjustable Chart	W
943,770 (21 Dec 1909)	Curran, Edward James, assigned one-half to David H. Ackerman	Australia (Sydney) New York (New York)	Apparatus for Drafting Garment-Patterns	W
945,814 (11 Jan 1910)	Schulze, Charles F.	Pennsylvania (Pottsville)	Method of Laying Out Patterns	M
946,191 (11 Jan 1910)	Augsten, Josef	Connecticut (Rockville)	Tailor's Fitting Apparatus	m W
947,542 (25 Jan 1910)	De Feo, Frank	Connecticut (Waterbury)	Measuring-Harness	M W
956,370 (26 Apr 1910)	Komura, Sanemon	California (San Jose)	Dress Chart and Templet	W
957,150 (3 May 1910)	Erickson, Anton	Oregon (Portland)	Tailor's Level	M
959,972 (31 May 1910)	Tomaselli, Antonio	Ohio (Cleveland)	Measuring-Rule for Tailors	M?
967,504 (16 Aug 1910)	Eden, Edward Samuel	Canada (Eastwood, Ontario)	Skirt-Drafting Quadrant	W
972,705 (11 Oct 1910)	Moritz, Samuel S.	Washington (Dayton)	Tailor's Measuring Apparatus	M
977,177 (29 Nov 1910)	Fellowes, Harry L.	Illinois (Chicago)	Measuring Device	M
979,866 (27 Dec 1910)	Little, James E.	Pennsylvania (Philadelphia)	Tailor's Measure	M
981,043 (10 Jan 1911)	*Weidel, Joseph A.	Missouri (St. Louis)	Drafting-Plate	W C
985,971 (7 Mar 1911)	*Blackburn, Juditha	California (Los Angeles)	Skirt-Pattern	W
986,041 (7 Mar 1911)	Bond, Ida M.	New Jersey (Forest Hill)	Garment-Fitter	W
988,459 (4 Apr 1911)	Gordon, Henry H.	New York (Huntington)	Tailor's Measuring Device	M
988,683 (4 Apr 1911)	Wurtzel, Abraham	New York (New York)	Measuring Appliance [Skirts]	W
991,103 (2 May 1911)	Titchell, Joseph	Illinois (Chicago)	Tape-Measure Attachment	M
996,281 (27 Jun 1911)	Rubin, Constantino Guerra	Mexico (Mexico [City])	Device for Taking Garment Measurements	M W
998,039 (18 Jul 1911)	Rose, Joseph	Ohio (Cleveland)	Pattern-Blank	W
998,258 (18 Jul 1911)	Osborne, Gertrude	Illinois (Neoga)	Tailoring Instrument	W
999,359 (1 Aug 1911)	Bauernfeind, John	Wisconsin (Medford)	Tailor's Square	M
999,425 (1 Aug 1911)	Zaino, Adolph	New York (New York)	Measuring-Tool	M W
1,000,151 (1 Apr 1911)	Contenti, Filiberto	New Jersey (Newark)	Measuring Device	M W
1,001,142 (22 Aug 1911)	Hanrath, Theodore W.	Illinois (Chicago)	Tape-Measure Attachment	M W?
1,002,613 (5 Sep 1911)	Ward, Ada	Oklahoma (Enid)	Tailoring Device	U
1,003,318 (12 Sep 1911)	Bartlett, Irene Merrill	New York (Manhattan)	Garment-Fitter	M W
1,004,593 (3 Oct 1911)	Ryan, Catherine	Canada (Ottawa)	Measuring Device for Cutting Garments	M W
1,009,427 (21 Nov 1911)	Luongo, Aniello	New York (New York)	Tailor's Measuring Instrument	U
1,011,628 (12 Dec 1911)	Klein, Jacob	New York (New York)	Tape-Measure	M
1,011,915 (19 Dec 1911)	Carbonara, Paolo	New York (Brooklyn)	Combined Tailor's Drafting Chart and Square	M
1,014,542 (9 Jan 1912)	Walquist, Andrew N.	Washington (Seattle)	Tailor's Measure	M
1,014,885 (16 Jan 1912)	Lee, Harriet	Missouri (Kansas City)	Garment-Fitter for Waists	W
1,033,061 (16 Jul 1912)	Cane, Pietro	New York (Coney Island)	Clip for Measuring Appliances	U
1,037,058 (27 Aug 1912)	Schmidt, Frank M.	Maryland (Havre de Grace)	Tailor's Measuring Apparatus	M W

<i>U.S. Patent</i>	<i>Patentee</i>	<i>Residence</i>	<i>Title</i>	<i>Clothing type</i>
1,041,611 (15 Oct 1912)	Farr, Eugene M.	New Jersey (Oradell)	Skirt-Measurer	W
1,042,063 (22 Oct 1912)	*Wendorf, William	Illinois (Chicago)	Tailor's Measuring Device	M W
1,045,440 (26 Nov 1912)	Rogati, Agostino, and Leonardo Montilli	New York (New York)	Dressmaker's Measuring Apparatus	W
1,045,449 (26 Nov 1912)	Sobotker, Paul E., and David H. Ackerman	New Jersey (Newark)	Garment-Fitter	M W
1,046,674 (10 Dec 1912)	Suzuki, George K.	California (Oakland)	Tailor's Adjustable Chart	M?
1,047,823 (17 Dec 1912)	Marsden, James	England (Wingan, Lancaster)	Process of Marking Cloth by Perforated Lays or Templets	M
1,048,929 (31 Dec 1912)	Baird, Jennie D.	Missouri (St. Charles)	Skeleton Skirt-Marker	W
1,049,536 (7 Jan 1913)	Rothenberger, George W., and William Hayden	Pennsylvania (Reading)	Adjustable Garment-Pattern	M
1,053,323 (18 Feb 1913)	Skrell, Joseph	Washington (Seattle)	Measuring Device	
1,068,143 (22 Jul 1913)	La Maida, Thomas	New York (New York)	Chart for Cutting Garments [Skirts]	W
1,069,086 (29 Jul 1913)	Johnson, Peter	New York (Brooklyn)	Tailor's Measure	M
1,072,908 (9 Sep 1913)	Buda, Pasquale	New York (Manhattan)	Method and Apparatus for Making Patterns	M W
1,078,087 (11 Nov 1913)	d'Orsogna, Louis S., and Pietro Cane	New York (Coney Island)	Pattern for Drafting and Fitting Garments	W
1,078,576 (11 Nov 1913)	d'Orsogna, Louis S., and Pietro Cane	Pennsylvania (Philadelphia)	Pattern for Drafting Garments	M W
1,079,333 (25 Nov 1913)	Goldberger, Max	Illinois (Chicago)	Tailor's Measuring Device	M
1,081,649 (16 Dec 1913)	Alfano, Louis	Connecticut (Southington)	Tailor's Measure	M
1,087,992 (24 Feb 1914)	Smoot, Charles Head	New York (New York)	Garment-Fitting Device	M? W
1,090,024 (10 Mar 1914)	Carroll, Morris	New York (Manhattan)	Tailor's Rule	M
1,092,737 (7 Apr 1914)	Mennis, May, and William A. Mead	Colorado (Denver)	Tailor's Measuring Apparatus	W
1,096,975 (19 May 1914)	Watters, Edward C.	Missouri (Kansas City)	Skirt-Measuring Tape	W
1,098,736 (2 Jun 1914)	Kramer, Harry J.	Massachusetts (Boston)	Method of Charting Dress-Patterns	W
1,098,737 (2 Jun 1914)	Kramer, Harry J.	Massachusetts (Dorchester)	Method of Laying Out A Skirt-Pattern	W
1,101,140 (23 Jun 1914)	Morrison, Margaret E.	Nebraska (Bartley)	Waist-Measuring Device	W
1,105,439 (28 Jul 1914)	Jensen, Albert J.	Canada (Vancouver)	Measure	U
1,108,040 (18 Aug 1914)	Watters, Edward C.	Missouri (Kansas City)	Dressmaker's Rule	W
1,113,612 (13 Oct 1914)	Glassman, Rubin	Maryland (Baltimore)	Measure for Garment-Cutters	U
1,114,658 (20 Oct 1914)	Watters, Edward C.	Missouri (Kansas City)	Skirt-Rule	W
1,121,410 (15 Dec 1914)	Scribante, Joseph	Pennsylvania (Pittsburgh)	Trial or Fitting Garment	M
1,123,031 (29 Dec 1914)	Spevacek, Vaclav	Michigan (Traverse City)	Tailor's Square	M
1,124,836 (12 Jan 1915)	Bell, Edward	Louisiana (New Orleans)	Garment-Fitting Device	M
1,136,055 (20 Apr 1915)	De Los Smith, Annesley	New York (Mount Vernon)	Chart for Garment-Patterns	W
1,142,298 (8 Jun 1915)	Breirly, Felix	Massachusetts (New Bedford)	Skirt-Drafting Instrument	W
1,144,071 (22 Jun 1915)	Semonof, Wolf	Rhode Island (Providence)	Tailor's Grading System and Device Therefor [sic]	M? W
1,148,135 (27 Jul 1915)	Agnes, Barthel	Illinois (Chicago)	Tailor's Measuring Appliance	M
1,149,434 (10 Aug 1915)	Ford, Hannah Maria	England (Bath)	Device for Measuring, Correcting, and Trimming Skirts and the Like	W

<i>U.S. Patent</i>	<i>Patentee</i>	<i>Residence</i>	<i>Title</i>	<i>Clothing type</i>
1,149,468 (10 Aug 1915)	*Russell, Maude W., assigned to Maude W. Russell New Method Dress Tailoring and Garment Cutting Company, Inc.	Missouri (Carterville) Missouri (Joplin)	Garment-Templet	W
1,155,690 (5 Oct 1915)	Taylor, Mary C., assigned one-half to Samuel Taylor	New Jersey (Perth Amboy) New Jersey (Jersey City)	Skirt-Measuring Device	W
1,157,085 (19 Oct 1915)	Cohen, Isaac	Massachusetts (Gloucester)	Garment-Fitter	M W
1,158,425 (2 Nov 1915)	Barnes, Leonora E.	Nebraska (Lincoln)	Tailor's Rule	M W
1,160,863 (16 Nov 1915)	de Girard, Emma Miot	California (Los Angeles)	Dress-Cutting Square	W
1,163,874 (14 Dec 1915)	*Weiler, Sigmond G.	Wisconsin (Milwaukee)	Cutting-Chart	W
1,168,431 (18 Jan 1916)	Schuman, Julius	California (San Francisco)	Measuring Instruments	M W
1,168,803 (18 Jan 1916)	Havrilla, Geza J.	Pennsylvania (Erie)	Tailor's Drafting-Chart	W
1,171,623 (15 Feb 1916)	Monaghan, David J.	New York (Rochester)	Garment-Pattern	M
1,173,226 (29 Feb 1916)	Taylor, Hiram H.	Massachusetts (Worcester)	Pattern-Drafting Device	M W C
1,173,301 (29 Feb 1916)	Murphy, Mary Caroline, and Mary Caroline, Jr.	Massachusetts (Haverhill)	Chart for Use in Cutting Garments	M W
1,175,996 (21 Mar 1916)	Rothenberg, George W., and William Hayden	Pennsylvania (Reading)	Adjustable Garment- Pattern	M
1,177,901 (4 Apr 1916)	Schuman, Julius	California (Los Angeles)	Measuring Instrument	M W
1,183,845 (23 May 1916)	*Bennett, Ella A.	Iowa (Dexter)	Dressmaking System	W C
1,183,942 (23 May 1916)	Yunkers, Edward H.	Illinois (Wilmette)	Tailor's Measuring Device	M
1,186,552 (13 Jun 1916)	Cohen, David, and Forest W. Weesner	Indiana (Wabash)	Shoulder-Measuring Device	M
1,187,128 (13 Jun 1916)	Bernhardt, Josiah D.	Pennsylvania (Reading)	Tailor's Measuring Device	M
1,198,499 (19 Sep 1916)	Widland, Theodore	New Jersey (Arlington)	Tailor's Adjustable Measure	M
1,199,591 (26 Sep 1916)	Melara, Lorenzo	New York (Orlean)	Tailor's Square	M W
1,200,035 (3 Oct 1916)	Schmit, Cestelle Leontine	Wisconsin (Milwaukee)	Drafting Instrument	W
1,201,217 (10 Oct 1916)	Miyamoto, Aki	California (San Francisco)	Tailor's Measure	W
1,204,900 (14 Nov 1916)	Picken, Mary B.	Pennsylvania (Scranton)	Garment-Maker's Square	M W C
1,205,240 (21 Nov 1916)	May, Jacob	New York (Richmond Hill)	Skirt-Measure	W
1,214,296 (30 Jan 1917)	Gorton, Josephine S.	Illinois (Chicago)	Instrument for Drafting Patterns for Garments	W
1,215,193 (6 Feb 1917)	Reed, Charles E.	Missouri (Warrensburg)	Tailor's Measuring Instrument	M?
1,218,435 (6 Mar 1917)	McLaren, Kate C.	Washington, D. C.	Chart or Master-Pattern	W C
1,218,565 (6 Mar 1917)	Kaeser, Robert	Wisconsin (Milwaukee)	Tailor's Measuring Device	M
1,219,234 (13 Mar 1917)	Brainerd, Lura S.	Connecticut (Meriden)	Dress-Waist Pattern	W
1,221,302 (3 Apr 1917)	Fischer, Joseph W.	Pennsylvania (Philadelphia)	Tailor's Measuring or Fitting Coat	M
1,222,012 (10 Apr 1917)	Meas, Augustus	New York (Niagara Falls)	Garment-Balancing Device	M?
1,236,272 (7 Aug 1917)	Costley, Emery E.	Maryland (Walkersville)	Measuring Device	M
1,237,958 (21 Aug 1917)	Reed, Charles E.	Missouri (Warrensburg)	Tailor's Measuring Instrument	M?
1,248,510 (4 Dec 1917)	Levi, Ernst	Germany (Stuttgart)	Measuring-Jacket for Ready-Made Clothing	M
1,254,197 (22 Jan 1918)	Berriman, Edward C.	Illinois (Chicago)	Measuring Instrument	M W?

<i>U.S. Patent</i>	<i>Patentee</i>	<i>Residence</i>	<i>Title</i>	<i>Clothing type</i>
1,255,734 (5 Feb 1918)	Galowitz, Joseph	New York (Manhattan)	Method of Making Special Patterns for Garments	M W
1,260,849 (26 Mar 1918)	Zech, Dorothy	Indiana (Lawrenceburg)	Garment-Temple	W
1,261,452 (2 Apr 1918)	Sorenson, Rasmus A.	Pennsylvania (Pittsburgh)	Apparatus for Measuring Garments	M
1,262,376 (9 Apr 1918)	Moyer, Anna E.	Pennsylvania (Schwenkville)	Dressmaking Appliance	W
1,267,054 (21 May 1918)	Carboni, Augusto	California (San Francisco)	Measuring Device	M W C
1,268,084 (4 Jun 1918)	Berriman, Edward C.	Illinois (Chicago)	Shoulder-Yoke	M
1,271,486 (2 Jul 1918)	Orvold, Oluf L.	Minnesota (St. Paul)	Measuring Device	M
1,272,729 (16 Jul 1918)	Towsley, Kathryn, and Irving S.	Pennsylvania (Philadelphia)	Profile-Recorder	M? W
1,276,316 (20 Aug 1918)	*Blackburn, Juditha	California (Los Angeles)	Dress-Pattern	W
1,278,107 (10 Sep 1918)	Cherrie, Etta, and Fannie Porter	Oklahoma (Enid)	Measuring Device	M? W
1,278,683 (10 Sep 1918)	Kramer, Harry J.	Massachusetts (Boston)	Garment-Making-Pattern Guide	U
1,283,076 (29 Oct 1918)	Clemens, Mattie M. L.	Illinois (Chicago)	Marking Device for Dressmakers	W
1,288,279 (17 Dec 1918)	Takahashi, Tsutomu	California (San Francisco)	Tailor's Measuring Instrument	M
1,292,056 (21 Jan 1919)	Remy, Jeanne	Louisiana (New Orleans)	Skirt-Measure	W
1,307,232 (17 Jun 1919)	Barody, Jean	Algeria (Constantine)	Guiding and Controlling Instrument for Cutting Clothes	M

Index to Patentees

(In the absence of a patent number, reference is by date)

Abrahart, William	272,611	Atwell, Fred A.	628,296	Baughman, Jacob S., and Melvina E.	422,282
Ackerman, David H.		Augsten, Josef	946,191	Baughman, Jacob	
See Edward James Curran; Paul E. Sobotker.		Avery, Mary Lucinda	705,194	Schrock	675,537
Acton, William R.	4,742	Axford, Edward I.	1,113	Beard, G.	48,644
Adamo, Giuseppe	710,399	Baasel, William	570,834	Beard, George	52,950
Adams, Margaret E.	215,310		570,835	Beard, George, Jr.	(5 Aug 1833)
Adamson, James M.	736,052	Bacon, G.W.M.	(20 Apr 1833)	Beaudry, Joseph	143,556
Adelberg, Abraham	711,611	Baird, Jennie D.	1,048,929	Bechtel, John R.	305,501
Agnes, Barthel	1,148,135	Baker, Elvira	349,198	Bell, Edward	1,124,836
Ahnelt, William P.	852,151	Ball, S. X. See George Eckler.		Bellamy, John	169,402
Alfano, Louis	1,081,649	Barber, Erastus	539	Bennett, Ella A.	1,183,845
Allen, William W.	(23 Oct 1827)	Barnes, Leonora E.	1,158,425	Bernhardt, Josiah D.	1,187,128
Allen, William W.	435	Barnett, Jacob	855,272	Bernheim, Matthew	422,067
Allen, William W.	7,641	Barnett, John P., and Francis Story	1,406	Berriman, Edward C.	1,254,197
Alm, Janos A.	515,511	Barody, Jean	1,307,232	Berry, Ellen A.	1,268,084
Amelang, Charles A.	466,111	Bartlett, Irene Merrill	1,003,318		433,711
Anderman, Goldie L.	851,391	Bauer, Zachaeus	158,194	Bisceglia, S. See Salvatore Bishe.	447,554
Anderson, Charles	716,613		163,911	Bisceglia, Salvatore	455,811
Anderson, E.			195,332	Bishe, Salvatore,	
Willoughby. See Moses Palmer.		Bauernfeind, John	999,359	and S. Bisceglia	447,932
Anderson, Samuel	902,704	Baughman, J. S., and M. E.	430,059	Bishop, William C.	179
Arvidson, Pier N.	483,521			Bixby, Lucy J.	187,587

Blackburn, Juditha	985,971	Christner, David C.	389,287	Emery, John A.	226,605
	1,276,316	Christoph, Emil A.	852,771	Ender, Richard	177,702
Blackburn, Richard H.	843,862	Choquette, Joseph H.	484,138	Erickson, Anton	957,150
Blizzard, Jennie	479,548		700,739	Ericson, Lars G.	465,252
Bluthenthal, Herbert Clay	629,025	Ciervo, Michael	927,948	Evan, H. P.	628,083
Bogardus, Abraham A.	4,294	Clemens, Mattie M. L.	1,283,076	Evangelista, Vincenzo	927,845
Bogushesky, Moses	933,523	Cohen, David, and Forest W. Weesner	1,186,552	Ewing, Sarah C.	112,024
Bond, Ida M.	986,041	Cohen, Isaac	1,157,085	Eyboulet, Jules François. <i>See</i> Louis Désiré Frenot.	
Boone, Thomas R.	212,587 743,436	Coleman, Mary V.	357,762	Faestel, A. L.	503,741
	670,762	Collins, Mary C.	606,706	Fairchild, Frederick A.	9,219X
Bowman, Viola		Colosimo, Giuseppe	797,176	Falk, Adolph, and J. Finkenstein	150,853
Brainerd, Lura S.	1,219,234	Combs, John P.	3,820	Farr, Eugene M.	1,041,611
Breirly, Felix	1,142,298	Cone, Abraham M.	497,165	Faut, P.	396,396
Brigham, S. O.	56,892	Contenti, Filiberto	1,000,151	Fellowes, Harry L.	977,177
Broadnax, John T.	455,159	Cook, W.	405,464	Fels, F., and Simon D.	379,384
Brolly, Hugh	277,453	Corley, Simeon	18,958	Ferguson, Mary A.	269,652
Brooke, Emily	355,583	Cornwell, Willett	209,111	Fike, Henry P.	409,184
Brooke, John A.	216,257	Costley, Emery E.	1,236,272	Finkenstein, J. <i>See</i> Adolph Falk.	
Brosnahan, Michael J.	850,340	Couteau, Jules	406,197	Fischer, Joseph W.	1,221,302
Brown, Daniel L.	534,387	Crakauer, Felix	558,780	Flenner, Lewis	2,341
Bruce, Mary E.	229,088	Crow, Samuel G.	480,453	Flint, Charles Ernest	869,169
Brundage, Henry C.	2,450	Cummins, W. G.	102,505	Flores, Alonzo Hernandez	86,829
Buccola, Joseph	831,826	Cunningham, Emma E.	622,419	Follett, Edward P.	389,376 389,377
Buckley, John P.	744,475		655,960		566,158
Buda, Pasquale	1,072,908	Cupler, Jacob C.	487,237		583,858
Buddington, Frank E.	272,204 440,692 541,311 618,392	Curran, Edward Curran, Edward James	718,320 711,479 758,826		611,995 692,510
		Curran, Edward James, assigned one-half to David H. Ackerman	943,770	Follett, Edward P., assigned to Zenith Manufacturing Company	735,738
Burrows, H. M.	89,735	Curry, Harriet A.	438,607	Ford, Hannah Maria	1,149,434
Byrnes, T. W.	282,842	D'Alessio, Agostino	760,966	Fowler, Henry A.	35,226
Call, Libbie A.	281,666 514,063	Dame, Richard	1,584	Franklin, Mrs. Minnie. <i>See</i> Mrs. Minnie Jones.	
		Davis, Loyola	753,680	Freeman, Ann M.	317,332
Campbell, Ethan (6 Nov 1823)	261,063	Davis, Myra A.	365,800	Freeman, Sarah Sophia	722,221
Campbell, John R.	490,606	de Caracena, Joseph O'N.	408,594	Freeman, William	790,568 811,770
Cane, Pietro	1,033,061	De Feo, Frank	947,542	Frega, G.	314,526
Cane, Pietro. <i>See also</i> Louis S. d'Orsogna.		de Girard, Emma Miot	1,160,863	Frega, Giuseppe	347,760 362,579 392,263 658,038
Carbonara, Paolo	1,011,915	D'Elia, Louis	826,651		
Carboni, Augusto	1,267,054	Delory, Jean Louis	614,703	Frenot, Louis Désiré, and Jules François Eyboulet	492,670
Carlstrom, John A., assigned to the Jno. J. Mitchell Company	918,279	De Los Smith, Annesley	1,136,055	Galowitz, Joseph	1,255,734
Carpenter, H. M.	57,837	Derby, Lyman	16,472	Ganzhorn, William	263,779
Carpenter, John	6,286	Di Domenico, Nicola	915,835	Garcelon, Jennie Lee	439,500
Carpenter, Mary F.	155,287	Dittenhafer, Catherine	56,383	Garnier, Martin J.	390,291
Carrara, Marie Louise	865,761	Dobbs, Edwin Eugene	851,279	Gartland, Elizabeth	355,160
Carroll, Morris	1,090,024	Dolan, Patrick W.	78,726	Gates, George Shattuck	310,666
Chambers, G. J., & E.	332,783	Donaldson, George MacKay	648,023	Geraci, Ignatius	480,579 813,415
Chandler, Helen S.	708,754	Donges, Henry	4,477		
Chandler, Mary B.	270,933	d'Orsogna, Louis S., and Pietro Cane	1,078,087 1,078,576		
Chappell, James H.	7,962X		451,553		
Charch, John S.	166,257 170,157	Drummond, George	926,322		
		Dubinsky, Moses	115,180		
Chenivresse, Jean M. Claudius	297,570	DuBois, Ithamar	890,969		
Cherrie, Etta, and Fannie Porter	1,278,107	Dufault, John U.	155,073		
Christiansen, S.	489,793	Eager, George R.			
Christiansen, Simon	526,378 526,379 526,380	Eckler, George, and S. X. Ball	3,286		
		Eden, Edward Samuel	967,504		

Glassman, Rubin	1,113,612	Hodges, Estell J., and Carrie R. Mathews	540,985		1,098,737
Goerigk, Franz	906,524	Hood, Eunice	363,237	Krider, J. M.	67,774
Goff Designer Company. <i>See</i> Vina Hildebrand			455,749	Krider, John M.	11,866
Goff.		Horeischi, Wenzel	882,111	La Maida, Thomas	1,068,143
Goff, Vina Hildebrand	662,620	Horn, Henrietta	490,022	Lambright, Hamilton	524,966
Goff, Vina Hildebrand, assigned to Goff			514,622	La Ment, P. A.	57,254
Designer Company	824,784	Horn, Marie	525,019	Lasar, Godfrey H.	190,686
Goldberger, Max	1,079,333	Horne, Rowlan G.	750,975	Laub, George M., assigned to May Manton	
Goldsberry, William H.	247,339	Hosford, Frank	782,339	Pattern Company	825,332
Goldsmith, Edwin M.	393,552	Hout, Emma M.	433,203	Leciejewski, Johann	646,498
Goodhue, Melissa	613,988	Hummer, David. <i>See</i> Cyrus Morey.		Ledoux, Francis	385,637
Goodwin, Terence J.	501,337	Hurdle, Rebecca	395,566	Lee, Harriet	1,014,885
	688,300	Isham, Henry	3,603	Lemley, Jacob	155,322
Gordon, Henry H.	988,459	Jackson, H. Ayers	259,162	Lemley, Jacob, Jr.	71,520
Gorton, Josephine S.	1,214,296		327,172	Lemmond, William J.	1,556
Gothard, James	420,448	Jackson, Louisa L.	90,363	Lemont, Levi Peterson	5,327X
Griffen, Stephen M.	537,285	Jacobsen, Martha	324,472	Lennards, Nicholas	281,530
	688,303	Jacobson, Hamlet Peter	894,207	Lennart, M.	441,369
	754,765	Jensen, Albert J.	1,105,439	Lent, J. M.	91,642
Griffin, Caleb H.	195,925	Johnson, Frank G.	365,385	Lesh, Edwin Zachariah, and Hester	
	206,315	Johnson, Jennie A.	910,203	A. Woolman	825,915
	228,527	Johnson, Mary A. Start. <i>See</i> Sampson S. Start.		Lette, Ursula L.	107,068
	234,273	Johnson, Mary M.	911,045	Leu, Mary D.	595,239
Griffin, Caleb Henry	194,086		911,046	Levi, Ernst	1,248,510
	195,926	Johnson, Peter	1,069,086	Lewis, Benjamin J.	7,817X
Griswold, Alice L. B.	281,056	Johnston, J. R.	140,507	Lewis, Richard R.	441,675
Groves, John Larue	266,137	Johum, Francis P.	419,452	Lewis, Sophronia T.	321,986
Gunkel, Caspar	486,670	Jones, Mrs. Minnie, now by remarriage		Liebl, Andrew	457,124
	509,080	Mrs. Minnie Franklin	819,438	Lillibridge, Warren and Charles F.	11,868
Hall, Martha E.	435,301	Kaesar, Robert	1,218,565	Linck, E. J.	252,388
	573,408	Kahler, William, and Charles	574	Linck, Emil J.	224,832
Hamilton, Doria C.	276,032	Kaiser, George B.	794,506	Lingen, Hermann	207,880
Hancock, Abram O.	590,495	Kantorovitz, Harris	543,253		312,211
Hand, J. S.	341,572	Kelley, Mary C.	535,378	Little, James E.	979,866
Hand, John S.	299,383		709,776	Livingston, Annie	556,856
	324,022	Kellogg, F. J.	235,776	Livingston, James W.	307,664
Hanrath, Theodore W.	1,001,142	Kellogg, Martha E.	435,182	Long, Flora	470,809
Harley, G.W.T.	52,566		937,214	Lucas, Charles	5,635
Harley, George W. T.	123,170	Kelly, Mark L.	455,338	Luongo, Aniello	1,009,427
Harrison, Margaret	188,896	Kennedy, H. G.	451,247	Lutz, Matthäus	516,828
Hartung, C.	245,717	Kenrick, Charles (8 Feb 1822)		McCann, James D.	334,457
Havender, Joseph	460,132	Kile, Conrad	4,596	McCartin, William J.	296,426
Havrilla, Geza J.	1,168,803	Kinker, Ellen K.	242,542	McCullough, Ophelia. <i>See</i> August F. Schrader.	
Hawkins, Thomas	362,378	Kirk, Benjamin H.	628,475	McDonald, Curran E.	60,028
Hawley, DeWitt	439,747	Kirk, Harry D., and Walter I.	661,537	McDowell, Albert	213,436
	518,947	Klein, Jacob	1,011,628		310,297
Hayden, William. <i>See</i> George W. Rothenberger.		Kleinberger, Markus	673,579	McDowell, William	689,685
Heaford, Edwin V.	215,613	Knowland, Joseph, and Jacob F.	2,730		787,533
Henderson, James, and Cooper K. Watson	6,807X	Koeller, Hermann. <i>See</i> Fritz Mueller.		McLaren, Kate C.	1,218,435
Hendrick, Susan M.	325,409	Kohn, Samuel	649,988	McLellan, Robert G.	179,808
Hendryx, Isaiah J.	1,557	Komura, Sanemon	956,370	McNaughton, J. <i>See</i> A. Sinnott.	
Henville, Amanda M.	156,086	Kramer, Harry J.	1,098,736	Madison, Otis (18 Aug 1823)	
Hilder, Henry William	745,841			Malnight, John	71,192
Hillman, Otto	739,178				
Hirsch, Phillip O.	765,837				
Hockersmith, Alfred P.	674,442				

Maginnis, James	8,566	Moschcowitz, Schamu M.	327,961	Porter, Fannie. <i>See</i>	
Ma Loney, Mato		Moses, Isaac	103,487	Etta Cherrie.	
Fitzmaurice	913,408	Moyer, Anna E.	1,262,376	Poulin, Hedwidge	510,364
Mandelbaum, Solomon	381,563	Mueller, Fritz, and		Propach, Henry	278,180
Mannebach, Caspar	482,748	Hermann Koeller	92,873	Pudney, John	(3 Sep 1831)
Manton, May, Pattern		Murphy, Mary Caroline,		Pusey, Caroline S.	347,888
Co. <i>See</i> George M.		and Mary Caroline, Jr.	1,173,301	Ratner, Henry W.	909,023
Laub.		Musse, Bertha	467,045	Reed, Charles E.	1,215,193
Marsden, James	1,047,823		487,760		1,237,958
Marshall, William J	535,843	Nelson, Jonathan	717,253	Reeves, Edward H.	195,308
Martin, Benjamin G.	4,831	Newcomb, Abner S.	519,090	Remy, Jeanne	1,292,056
Matheson, Hugh	124,602	Newtown, Charles		Rencher, Dora	678,515
Mathews, Carrie R. <i>See</i>		Willard	871,814	Rensen, John Henry	480,036
Estell J. Hodges.		Nicholas, Eliza	622,900	Ricciardi, Bartolomeo	845,319
Mathews, W. A.	560,593	Nichols, J. H.	179,046		869,264
Maxwell, Alice Audley	885,167	Nichols, James H.	169,468	Rich, Ellen P.	185,352
May, Jacob	1,205,240	Noar, F. C.	385,944	Richardson, E., M.,	
Mayer, William H.	121,642	Nordstrom, Fred	809,836	and J. L.	616,493
Mead, William A. <i>See</i>		Northen, Mary E.	325,216	Richardson, Samuel S.	3,522
May Mennis.		Northen, Mary Eva	761,901	Richey, Albert H.	165,026
Meas, Augustus	579,491	Obermeier, Ludwig	777,913	Riley, Marsha E.	223,543
	1,222,012	O'Donnell, Mary F.,		Robbert, Jane	748,792
	1,199,591	and Emma V.	734,279	Robinson, Lucie	242,696
Melara, Lorenzo		O'Halloran, E. E.	431,781	Rockafellow, John S.	9,110X
Melcher, Michael A.,		Oliver, Thomas	3,024	Rogati, Agostino, and	
and Lewis A.	169,564	O'Loughlin, Robert S.	632,361	Leonardo Montilli	1,045,440
Melick, James T.	633,654	Olsen, John R.	534,347	Roland, Arthur Malaska	830,850
Mendenhall, James	(16 Apr 1833)	Olson, Jennie S.	325,358	Rondel, Pierre	174,443
Mengel, Herman [sic]	77,704	Ordway, Ira J.	98,618	Rose, Joseph	998,039
Mengel, Herrmann	61,349	Ormsby, Albertha A.	599,247	Roseen, E.	70,621
Mennis, May, and		Orvold, Oluf L.	1,271,486	Rosenbloom, Abe N.	660,397
William A. Mead	1,092,737	Osborne, Gertrude	998,258	Ross, Greenberry	(5 Apr 1826)
Michael, W. M.	97,672	Osler, H.	38,757	Rothenberger, George W.,	
Miles, Nancie E.	900,568	Osse, Charles	522,800	and William Hayden	1,049,536
Miller, Jonathan J.	105,355	Palmer, E. Ellsworth	252,507		1,175,996
Miller, Lyman B.,		Palmer, Moses, and E.		Rowlands, Mosses [sic] T.	10,779
and Ellery	2,106	Willoughby Anderson	105,486	Rubin, Constantino Guerra	996,281
Millwee, Sarah A.	126,825	Parker, George F., and		Rugland, Samuel C.	282,670
Mitchell, Jno. J.		Marie E. M. Whiting	740,172		305,849
Company. <i>See</i> John			823,738	Russell, Maude W.,	
A. Carlstrom.		Parkhill, Joseph H.	265,628	assigned to Maude	
Miyamoto, Aki	1,201,217	Pelton, Marie C.	875,554	W. Russell New	
Moccia, Raffaele	568,263	Pendell, David L.	3,130	Method Dress	
Moe, Gerhard	689,361	Penley, Julia	337,016	Tailoring and Garment	
	865,418		410,695	Cutting Company, Inc.	1,149,468
Monaghan, David J.	1,171,623	Peterson, Erick H.	851,374	Ryan, Catherine	717,284
Mongelli, Giuseppe A.	941,936	Peterson, Erick H.,			1,004,593
Monjou, Jean	283,638	assigned to Sartorial		Ryan, Della	516,449
Montilli, Leonardo.		Pattern Company	928,691	Sartorial Pattern	
<i>See</i> Agostino Rogati.		Peyry, J. B.	626,795	Company. <i>See</i> Erick H.	
Moon, Edwin L.	554,710	Peyser, Abraham	245,654	Peterson.	
Morey, Cyrus, and		Phelps, Brigham T.	279,979	Scanlan, John	233,441
David Hummer	3,161	Phelps, Ernest Leslie	812,874	Schad, Anton	343,859
Morgan, Lucy W.	731,115	Phoebus, Virginia A.	873,266	Schafer, May S.	287,731
Moriarty, John H.	432,322	Picken, Mary B.	1,204,900		457,591
	441,684	Pinkham, Almeda A.	602,471	Schafer, Theodore	510,994
Moritz, Samuel S.	972,705	Plant, Harry N.	782,415	Schell, Natalic	582,101
Morrison, Margaret E.	942,338		815,467	Schierbaum, Clara	667,739
	1,101,140	Plant, John B.	662,817	Schindler, Franz	559,045
Moschcowitz, Herman	246,536	Pohle, Jenny	899,802	Schmidt, Frank M.	1,037,058
	350,073	Pollock, William Bloomer	320,496	Schmidt, John J.G.C.	327,725
Moschcowitz, Schamu	111,236				

Schmit, Celestine		Stillwell, S. B.	4,083	Venner, William G.	458,263
Leontine	1,200,035	Stocker, Amos	15,824	Veret, Peter F. L.	2,640
Schoepl, Joseph F.	874,997	Stockman, Terissa I.	400,504	Viau, Benjamin	487,801
Schrader, August F., and Ophelia		Stoker, Amos	7,402	Virtue, Edward	8,600
McCullough	834,762		A195	Wachter, Anton	383,926
Schreckengaust, Julia A.	129,603		[7402]	Wakefield, Ernest	744,826
Schubert, Carl	411,686	Storey, James R.	537,132		765,407
Schulze, Charles F.	945,814		552,976	Walker, Kate	254,074
Schumacher, Jacob	353,508	Story, Francis. <i>See</i>		Walkie, Jennie	452,090
Schuman, Julius	1,168,431	John P. Barnett.		Wallace, William	284,783
	1,177,901	Subera, Harry W.	185,842	Walquist, Andrew N.	1,014,542
Scott, Charles H.	584,413	Suzuki, George K.	1,046,674	Ward, Ada	1,002,613
Scott, Herman W.	537,127	Sweezy, George P.	89,091	Ward, Allen	(16 Jun 1821)
Scribante, Joseph	1,121,410		109,076		5,234X
Scully, Harry Francis	435,714	Takahashi, Tsutomu	1,288,279		(7 Jan 1835)
Sebastiano, Domenico	651,208	Taylor, Anna Bell	648,714		415
See, James W.	369,080	Taylor, David Jackson	266,919	Waterman, Albert	843,378
Seger, Hiram	2,590	Taylor, Hiram H.	594,443	Watson, Cooper K. <i>See</i>	
	4,367		1,173,226	James Henderson.	
Semonof, Wolf	1,144,071	Taylor, Mary A.	234,821	Watters, Edward C.	1,096,975
Sens, Herman A.	389,327	Taylor, Mary C., assigned			1,108,040
Severson, Stephen	(15 Mar 1826)	one-half to Samuel			1,114,658
Sexton, Edith Ray	938,280	Taylor	1,155,690	Watt, Thomas	4,975
Shane, Carrie	451,979	Taylor, Samuel. <i>See</i>		Webster, Frank D.	943,130
Shawcross, Samuel	101,052	Mary C. Taylor.		Webster, Ursula L.	200,234
Shelton, Zelda G.	641,411	Ten Eyck, M. C.	168,936	Weesner, Forest W. <i>See</i>	
Sherman, Amos	283	Tentler, Aaron A.	1,944	David Cohen.	
Simril, Miles G.	4,923	Terry, Reed A.	931,896	Weidel, Joseph A.	981,043
Sinnott, W., and		Thompson, Ethan O.	200,779	Weiler, Sigmond G.	1,163,874
J. McNaughton	79,083	Thompson, Reinard	860,773	Weir, John	358,903
Sipe, Thalia E.	497,503	Tierney, Catharine A.	322,402	Wells, William T.	8,895
Sipperly, David N.	3,160	Tierney, D.	78,338	Wendorf, William	1,042,063
Skrell, Joseph	1,053,323	Tiffany, G. E.	164,343	West, J. B.	45,780
Smith, Mrs. E. P.	137,967	Tiffany, George S.	932,649	Westcott, Benjamin F.	719,924
Smith, F. B.	164,943	Tight, Jennie C.	822,874	Weston, James M.	19,271
Smith, John	130,161	Tilden, Thomas E.	1,880	Wetmore, Fannie	110,097
Smith, Prudence A.	460,282	Tilney, William DeCaux	165,383	White, J. H.	626,258
Smith, William	367,455	Titchell, Joseph	991,103	Whiting, Marie E. M. <i>See</i>	
Smith, William E.	101,390	Tomaselli, Antonio	959,972	George F. Parker.	
Smoot, Charles Head	1,087,992	Towsley, Kathryn, and		Wickersham, Angeline P.	242,240
Snyder, Charles W.	546,199	Irving S.	1,272,729	Widland, Theodore	1,198,499
Sobotker, Paul E., and		Tripp, Frances A.	394,524	Wiggins, Thomas H.	507,054
David H. Ackerman	1,045,449	Trochu, Athanase	483,271	William, I.	602,117
Sole, Frank D.	798,223	Truhan, Michael	890,472	Williams, Daniel	7,591X
Sorenson, Rasmus A.	1,261,452	Tucek, Marie	532,613		1,136
Spevacek, Vaclav	1,123,031		600,050		RE11
Spilman, Peter	11,339		622,092		[7,591X]
Stace, W. R.	20,826	Turner, M. M.	46,409		A131
Stahl, E.	376,558	Ullrich, Friedrich H.	167,957		[1,136]
Stahl, Edward	410,383		169,744	Williams, William R.	660,175
Starr, N. B.	(10 July 1826)	Ulrich, Jean	765,691	Wilson, Harry C.	664,700
Start, May A.	251,963	Valentine, Gustaf V.	708,506		690,214
Start, S. S., and Mary			887,890	Wilson, James G.	4,687X
A. S. Johnson	510,942	Van Dame, J. R.	613,095		7,566X
Start, Sampson S., and		Van Dame, John R.	618,387	Wilson, Josephine Sarah	375,972
Mary A. Start Johnson	545,139		790,333	Windle, Susan R.	76,128
Stearns, Elvira	405,614	Van Derworp, Anna M.	593,555	Wingate, Julia P.	204,120
Steiner, Carl A.	182,968	Vandoren, Theodore, Sr.	72,432	Wiswell, Andrew	7,112X
Stevenson, J. W.	453,923	Vaughn, Archer	586,406		256
Stillman, Millicent M.	847,844	Veitch, William	517,079	Wiswell, William M.	1,119
		Venner, William	185,412		

Wolff, Rudolph G.	456,184	Wuerfel, Julia	196,615	Zech, Dorothy	1,260,849
Woolman, Hester A. <i>See</i> Edwin Zachariah Lesh.		Wurtzel, Abraham	988,683	Zenith Manufacturing Company. <i>See</i> Edward P. Follett.	
Woolson, H. H.	225,678	Yates, S. W.	403,404	Zwisler, James, Jr.	9,860X
Woolson, Harry H.	909,046	Yunkers, Edward H.	1,183,942		
Wuerfel, Augusta J.	364,620	Zaino, Adolph	999,425		

Appendix IV

Tables of Geographic Distribution

TABLE A.—Distribution by state of instruction books at Library of Congress, arranged by decade (cities considered separately are not included in state data; sequence of data shows number of publications giving instructions for women's garments followed, in parentheses, by a total that includes booklets concerned with, but not predominantly for, women's attire; data derived from Appendix I, periodicals excluded)

State	1800-09	1810-19	1820-29	1830-39	1840-49	1850-59	1860-69	1870-79	1880-89	1890-99	1900-09	1910-19
Alabama	-	-	-	-	-	-	-	-	(1)	1(1)	-	-
California	-	-	-	-	-	-	-	1(1)	7(7)	(1)	-	2(2)
Connecticut	-	-	-	-	-	-	-	(1)	-	-	-	-
Georgia	-	-	-	-	-	-	-	-	1(1)	(1)	-	1(1)
Illinois	-	-	-	-	-	-	-	-	4(4)	1(1)	1(1)	2(2)
Chicago	-	-	-	-	-	-	-	-	16(18)	15(17)	4(5)	2(3)
Indiana	-	-	-	-	-	-	1(1)	2(2)	2(2)	-	-	-
Iowa	-	-	-	-	-	-	-	1(1)	(2)	1(1)	-	2(2)
Kansas	-	-	-	-	-	-	-	-	1(1)	1(1)	-	-
Kentucky	-	-	-	-	-	(1)	-	-	1(1)	-	-	-
Louisiana	-	-	-	-	-	-	-	-	-	1(1)	1(1)	-
Maine	-	-	-	-	-	-	-	-	1(1)	-	-	-
Maryland	-	-	-	-	-	-	-	-	1(1)	-	-	-
Massachusetts	-	-	-	-	-	-	-	1(1)	2(2)	-	-	-
Boston	-	-	-	-	-	-	1(1)	6(6)	6(6)	3(3)	1(1)	-
Michigan	-	-	-	-	-	-	-	-	6(6)	1(1)	1(1)	-
Minnesota	-	-	-	-	-	-	-	-	2(2)	2(2)	1(1)	-
Missouri	-	-	-	-	-	(1)	-	1(2)	5(9)	6(7)	-	3(3)
Nebraska	-	-	-	-	-	-	-	-	-	1(1)	-	-
New Jersey	-	-	-	-	-	-	-	-	-	1(1)	-	-
New York State	-	-	-	-	-	-	-	-	4(4)	1(1)	1(1)	(1)
New York City	-	-	(1)	-	-	-	-	10(12)	20(21)	10(11)	10(13)	11(11)
Ohio	-	-	-	-	-	1(2)	(1)	-	12(13)	(1)	-	-
Oklahoma	-	-	-	-	-	-	-	-	-	-	-	1(1)
Oregon	-	-	-	-	-	-	-	-	-	-	-	1(1)
Pennsylvania	-	-	-	-	-	-	-	-	1(1)	1(1)	-	1(1)
Philadelphia	(1)	-	-	-	1(2)	1(1)	-	-	4(4)	3(3)	1(1)	-
Rhode Island	-	-	-	-	-	-	-	-	2(2)	-	-	-
Texas	-	-	-	-	-	-	-	-	-	1(1)	-	-
Vermont	-	-	-	-	-	-	-	-	2(2)	1(1)	-	-
Washington, D.C.	-	-	-	-	-	-	-	-	1(1)	4(4)	-	-
Wisconsin	-	-	-	-	-	-	-	-	3(3)	1(1)	1(1)	1(1)

TABLE B.—Distribution by state of U.S. patents that are related to drafting systems for assorted clothing, arranged by decade (cities considered separately are not included in state data; sequence of data shows, first, the number of patents related to systems designed for drafting exclusively men's garments, second, the number for women's garments, and finally, in parentheses, a total of these two categories plus patents not classified under either of them; data from Appendix III)

State	1820-29	1830-39	1840-49	1850-59	1860-69	1870-79	1880-89	1890-99	1900-09	1910-19
Alabama	0,0(1)	—	—	—	—	—	—	—	—	—
Arizona	—	—	—	—	—	—	0,2(2)	—	—	—
Arkansas	—	—	—	—	—	—	—	1,0(1)	—	—
California	—	—	—	—	0,1(1)	—	5,3(8)	0,1(1)	0,1(2)	1,5(10)
Colorado	—	—	—	—	—	—	—	—	0,3(4)	0,1(1)
Connecticut	—	—	—	—	—	0,1(1)	—	—	—	1,1(4)
Delaware	—	—	—	—	—	—	—	0,1(1)	0,0(1)	—
Georgia	—	1,0(1)	2,1(3)	—	—	—	0,1(1)	0,1(1)	—	—
Hawaii	—	—	—	—	—	—	—	—	1,0(1)	—
Illinois	—	—	—	—	—	1,0(2)	3,0(5)	3,0(3)	—	1,1(2)
Chicago	—	—	—	—	—	0,3(3)	3,2(5)	10,8(19)	3,8(15)	5,2(10)
Indiana	—	—	—	—	1,2(3)	2,1(4)	0,3(4)	0,3(4)	0,2(3)	1,1(2)
Iowa	—	—	—	—	—	0,0(1)	2,3(7)	2,3(5)	0,3(3)	0,0(1)
Kansas	—	—	—	—	—	—	—	0,1(1)	0,2(3)	—
Kentucky	0,0(1)	—	1,0(1)	—	—	0,1(1)	1,0(1)	—	—	—
Louisiana	—	—	—	—	—	—	—	1,2(3)	—	1,1(2)
Maine	1,0(1)	1,0(1)	0,1(1)	—	—	0,0(1)	0,3(3)	0,2(2)	0,4(4)	—
Maryland	0,0(1)	1,0(1)	2,0(2)	—	1,0(1)	2,0(2)	1,1(2)	2,0(3)	1,1(2)	1,0(3)
Massachusetts	—	—	—	—	—	0,5(5)	1,0(2)	3,6(9)	4,2(6)	0,2(5)
Boston	—	1,0(1)	—	—	—	4,1(6)	1,4(5)	0,1(2)	0,2(3)	0,1(2)
Michigan	—	—	—	—	0,2(2)	1,1(2)	0,1(1)	1,5(8)	0,2(2)	1,0(1)
Minnesota	—	—	—	—	—	1,1(2)	0,2(2)	2,3(6)	0,1(1)	1,0(1)
Missouri	—	—	—	—	—	4,0(5)	1,1(2)	3,1(4)	1,3(5)	0,6(9)
Nebraska	—	—	—	—	—	—	0,1(1)	—	1,5(6)	0,1(2)
New Hampshire	—	2,0(2)	1,0(1)	—	—	—	0,1(1)	0,2(2)	0,1(1)	—
New Jersey	—	2,0(2)	1,0(1)	1,0(1)	1,0(1)	1,0(1)	2,0(2)	3,1(4)	1,0(3)	1,3(6)
New York State	0,0(1)	2,0(3)	7,0(7)	5,1(6)	1,3(4)	4,1(6)	1,3(6)	5,4(9)	0,4(6)	2,1(9)
New York City	1,0(2)	4,0(5)	3,0(3)	1,0(1)	6,1(7)	6,1(7)	1,13(16)	4,14(19)	6,16(25)	4,5(12)
Ohio	—	3,0(3)	3,0(3)	0,0(1)	2,3(5)	4,1(5)	3,1(4)	1,5(6)	0,1(2)	0,1(2)
Oklahoma	—	—	—	—	—	—	—	—	—	0,0(2)
Oregon	—	—	—	—	—	—	0,2(2)	—	—	1,0(1)
Pennsylvania	—	3,0(5)	2,0(2)	1,0(1)	—	2,0(2)	2,0(4)	1,2(3)	1,2(4)	6,2(9)
Philadelphia	1,0(4)	1,0(2)	1,1(2)	1,0(1)	3,0(3)	1,2(3)	4,7(12)	1,1(2)	3,2(9)	2,0(4)
Rhode Island	—	—	—	—	—	—	0,1(1)	—	0,0(1)	0,0(1)
South Carolina	—	—	2,0(2)	1,0(1)	—	0,1(1)	—	—	—	—
South Dakota	—	—	—	—	—	—	—	0,1(1)	0,0(1)	—
Tennessee	—	—	—	1,0(1)	—	1,0(1)	—	—	—	—
Texas	—	—	—	—	—	—	0,0(1)	—	0,0(2)	—
Utah	—	—	—	—	—	—	—	—	0,1(1)	—
Vermont	—	—	1,0(1)	—	—	—	1,1(2)	—	—	—
Virginia	—	—	3,0(3)	2,0(2)	2,0(2)	1,0(1)	—	—	—	—
Washington	—	—	—	—	—	—	—	1,0(1)	1,0(1)	2,0(3)
Washington, D.C.	—	—	—	—	1,0(1)	2,0(2)	0,1(1)	2,0(2)	2,0(3)	0,0(1)
West Virginia	—	—	—	—	—	1,0(1)	1,0(1)	—	—	—
Wisconsin	—	—	—	—	—	—	0,2(4)	1,2(4)	0,0(2)	2,2(4)

Literature Cited

- A. McDowell & Co. See McDowell & Co., A.
 Ackermann, R. See *Repository of Arts*
 Altman & Co., B. See B. Altman & Co.
 "American Lady"
- 1844 *The Ladies' Hand-book of Millinery and Dressmaking, with Plain Instructions for Making the Most Useful Articles of Dress and Attire*. New York: J. S. Redfield.
- Arnold, Janet
 1964. *Patterns of Fashion: Englishwomen's Dresses and Their Construction c.1660-1860*. London: Wace and Company.
 1973. *A Handbook of Costume*. London: MacMillan.
- B. Altman & Co. *Catalogue* (Fall and Winter 1888-1889), number 58.
- Bayne, J. Reid
 1883. *Bayne's Self-Instruction Book for Dress Cutting by the French Glove-fitting Tailor System, by Exact Measure: A Manual for the Use of Bayne's Paris Scale*. New York: Privately printed.
- Bellas Hess & Co. Catalogue* (Fall and Winter 1912-1913).
Le Bon Ton (Jul 1857); (Dec 1858); (Nov 1860); (Nov 1861).
 Buddington, Mr. and Mrs. F. E.
 1887. *Supplement Studies for Those Using the Buddington Dress Cutting Machine*. Chicago: Privately printed.
 1896. *Instruction Book for Using the Buddington Improved Dress Cutting Machine with Dart Attachment for Cutting French Bias Basque, Enlarging Darts, etc.* 1st edition. Chicago: Privately printed.
- Burke, Edmund. See U.S. Patent Office.
 Butterick & Co., E. See E. Butterick & Co.
Butterick's Quarterly Advertiser (Fall 1867).
 Chappell, James H.
 1839. *The Patent Transfer System of Measuring and Delineating Garments, with the Transfer Ellipsis*. Philadelphia: Privately printed.
 1853. *The Graduated Delineator*. Pennsylvania: Privately printed. [Uncatalogued sheet of paper, 57.2 × 57.2 cm, in Prints and Photographs Division, Library of Congress.]
- Chapelle, Howard I.
 1967. *The Search for Speed under Sail 1700-1855*. New York: W. W. Norton & Company.
- Clavé, Justin
 1859. *To the Ladies: New Geometrical Method; or, Easy and Infallible Manner of Taking the Measure, Drafting and Cutting Dresses of Ladies . . . According to a System of Proportions Adapted to the Human Body*. Philadelphia: Privately printed. [The Library of Congress catalogued this single sheet of paper as a book; it is, in fact, a perforated tool for a proportional system.]
- Cornwell, Willett
 1885. *Cornwell's New Improved Self Fitting Chart and Sleeve System for Cutting Ladies', Misses', and Children's Dresses Cloaks, Basques, and Postillions*. Chicago: Privately printed.
- The Delineator* (Aug 1901), volume 58(2).
 Demorest's . . . , Mme. See Mme. Demorest's . . .
Demorest's Monthly Magazine (Jun 1872), volume 8(6); (Jun 1876), volume 12(6); (Dec 1876), volume 12(12); (Aug 1876), volume 12(8). [Issued under various titles including *Demorest's Illustrated Monthly*.]
- Diderot, Denis
 1776-1777. *Supplément à l'Encyclopédie, ou Dictionnaire Raisonné des Sciences, des Arts et des Métiers* Amsterdam: M. M. Rey
- E. Butterick & Co.'s *Celebrated Patterns of Garments for Ladies, Misses, Boys, Little Children of Both Sexes, and for Gentlemen's Shirts* (1869?).
 E. Butterick & Co.'s *Illustrated Catalogue of Patterns* (Spring and Summer 1876).
The Elite Dressmaker and Milliner (Mar 1878), volume 2(8).
 Garsault, M. de
 1769. *L'Art du tailleur. Descriptions des arts et métiers*, volume 31. Paris: Academie des Sciences.
- Garland, Elizabeth
 1884. *The Original American Lady Tailor System*. Philadelphia: Privately printed.
- Giles, Edward B.
 1887. *The History of the Art of Cutting in England, Preceded by a Sketch of the History of English Costumes*. London: F.T. Prewett, Messers. Kent & Co., and Jno. J. Mitchell & Co. [An important publication used in preparing this monograph not only for quotations for cited sources (Hearn, 1818 and 1823; Minister, 1820; and Society of Adepts, 1796) which were not available otherwise, but for much general information about the art of tailoring in England in the early 19th century.]
- Godey's Lady's Book* (Sep 1851), volume 43; (Feb 1854), volume 48(16); (May 1854), volume 48(19); (Jun 1854), volume 48(20); (Feb 1855), volume 50; (Jul 1855), volume 51.
- Harper's Bazar* (2 Nov 1867), volume 1(1); (12 Dec 1868), volume 1(59); (7 May 1870), volume 3(19); (21 Oct 1871), volume 4(42); (22 Feb 1873), volume 6(8); (19 Jan 1884), volume 17(3); (5 Jul 1884), volume 17(27).
- Hearn, Mr.
 1818. *Rudiments of Cutting, with an Easy Guide to the Use of the Tape Inch Measure*. England. [Reported in Giles, 1887:92-99.]
 1823. *Rudiments of Cutting with an Easy Guide to the Use of the Tape Inch Measure*. 5th edition. England. [Reported in Giles, 1887:100-117.]

- Hecklinger, Charles
1886. *Hecklinger's Ladies' Garments, a Text Book: How to Cut and Make Ladies' Garments . . .* New York: Privately printed.
- Holbrook & Co.
1870. *Zebina Holbrook's Universal Dress Cutting Chart for Cutting Ladies' Dresses & Children's Clothes*. Massachusetts: Privately printed. [Uncatalogued sheet of heavy paper, 78.1 × 63.2 cm, in Prints and Photographs Division, Library of Congress.]
- Hubert, Philip G., Jr.
1894. Occupations for Women. *The Woman's Book*, volume 1. New York: Charles Scribner's Sons.
- Hummel, Charles F.
1968. *With Hammer in Hand: The Dominy Craftsmen of East Hampton, New York*. Charlottesville: The University Press of Virginia. [Published for The Henry Francis du Pont Winterthur Museum.]
- Inwood, Mrs. D. A.
1863. *Mrs. D. A. Inwood's Book of Instructions for Her Five Measure System of Dress Cutting, for Cutting Ladies' and Children's Dresses, Basques, Boy's Clothing, and Gentlemen's Shirts*. Boston: Privately printed.
- Jackson, Louisa L.
1876. *The Science and Geometry of Dress: Being a Complete Manual of Instruction in the Art of Designing, Drafting and Cutting Ladies' and Children's Wearing Apparel . . .* Indianapolis: Privately printed.
- Johnson, Jacob
1807. *The Book of Trades or Library of the Useful Arts, First American Edition*. Volume 3. Philadelphia and Richmond: Jacob Johnson.
- Jones, Amanda
1822. *The Taylor's Assistant and Family's Director Comprising Rules and Directions for Cutting Men's Clothes by the Square Rule*. Middlebury: Privately printed.
- Journal des Demoiselles* (Sep 1876), volume 44.
- Kidwell, Claudia B.
1976. Bicentennial Outlook: Riches, Rags, and In-between. *Historic Preservation*, 28(3):28–33.
- Kidwell, Claudia B., and Margaret C. Christman
1974. *Suiting Everyone: The Democratization of Clothing in America*. Washington: Smithsonian Institution Press.
- The Lady's Book* (May 1839).
- The Lady's Magazine* (Jul 1834), series 4, volume 6.
- Lerner, Gerda
1973. The Lady and the Mill Girl: Changes in the Status of Women in the Age of Jackson. *Women and Womanhood in America*, pages 90–102. Lexington, Massachusetts: D.C. Heath and Company.
- Lord & Taylor Catalogue* (1881) number 26 [reprinted in 1971 as *Clothing and Furnishings, Lord & Taylor 1881*, Princeton: The Pyne Press]; (Spring and Summer 1883), number 30.
- McAllister & Brother
1855. *Illustrated Catalogue of Optical, Mathematical, and Philosophical Instruments, for Sale by McAllister & Brother, Opticians . . .* Philadelphia: Privately printed.
- McCall, James
1882. *Instruction Book for the French and English Systems of Cutting, Fitting, and Basting*. New York: Privately printed. [Three sections ("Series") with separate pagination were issued in one volume.]
- McCall's Bazar Glove Fitting Patterns* (Fall and Winter 1884–1885).
- McDowell & Co., A.
1892? *Madame Dorvaux's Experience: How She Became an Expert in Cutting and Fitting*. New York: A. McDowell & Co. [Advertising leaflet.]
- McDowell Garment Drafting Machine Co.
1883. *Instruction Book for Drafting and Cutting Dresses, Basques, Sacks, Coats, etc. by the Garment Drafting Machine, As Invented and Patented by A. McDowell*. New York: Privately printed.
1891. *Instruction Book for Drafting and Cutting Dresses, Basques, Sacques, Coats, etc., by the Garment Drafting Machine, As Invented and Patented by A. McDowell*. [Revised.] New York: Privately printed.
- McMillen, Mrs. H.
1864. *The American Delineator*. Clyde, Ohio: Privately printed. [Perforated drafting tool.]
- Mallison, Mme. E. W.
1886. *Dress Making Reduced to a Science: The Eclectic Lady-Tailor System of Dress Cutting*. Washington, D.C.: Privately printed.
- Marzio, Peter C.
1976. The Art Crusade: An Analysis of American Drawing Manuals, 1820–1860. *Smithsonian Studies in History and Technology*, 34: 94 pages.
- Melder, Keith E.
1972. Woman's High Calling: The Teaching Profession in America, 1830–1860. *American Studies*, 13:19–32.
- The Metropolitan* (Feb 1872); (May 1872).
- Minier, Dr. E. P.
1857. *Self-Teaching Dress Making System: Science Applied to Dress Cutting, the Art Perfected, Simplified and Reduced, in the Process of Drafting, to Mathematical Precision, Accompanied with Copious Illustrations and Examples, with Full and Perfect Directions for Self-Instruction*. 2nd edition. Cincinnati: Privately printed.
- Minister, Edward
1820. *System of the Art of Cutting*. [Reported in Giles, 1887:131–133.]
- Mirror of Fashion* (Feb 1849), volume 11.
- Moschcowitz Bros.
1884. *Instructions in Dressmaking, Basting, and Fitting, as Set Forth by the Moschcowitz Model Waist Lining*. New York: Privately printed.
- Mme. Demorest's What to Wear* (Fall and Winter 1877–78).
- Mme. Demorest's Quarterly Mirror of Fashion* (Fall 1861); (Summer 1864).
- Noland, Joseph H.
1861. *The Sycle and Anatomical Survey System of Delineating the Human Form*. Privately printed. [Uncatalogued sheet of paper, 95.2 × 63.5 cm, in Prints and Photographs Division, Library of Congress.]
- Norman, Mrs. N. R.
1881. *Lessons on Centennial Patterns No. 4: Norman System Improved 1881*. St. Louis: Privately printed.
- Palmer, Mrs. E. E.
1886. *Instructions in Dress Cutting Complete, with Diagrams*

- Explaining Every Pattern, to Be Used Expressly for the Gem Tailor System . . .* Baraboo, Wisconsin: Privately printed.
1892. *Instructions in Dress Cutting with Diagrams, etc., Complete, to Be Used Expressly for the Gem Tailor's System of Cutting.* Revised edition. Chicago: Privately printed. *Peterson's Magazine* (Mar 1855), volume 27(31); (May 1876), volume 69(5). *Le Petit Messenger, Modes de Paris* (Feb 1867), volume 2(2).
- Peyry, Jean B.
1904. *Instructions [sic] Book with Diagrams and Designs for the Conformateur and Systeme Metrique for Cutting Ladies', Children's and Gentlemen's Garments, New Edition for Ladies' and Children's Garments.* New Orleans: Privately printed.
- Phelps, Mr. and Mrs. B. T.
1883. *Instructions for Using the Excelsior Square, a Glove Fitting System for Ladies' and Children's Garments.* 2nd edition. Bellows Falls, Vermont: Privately printed.
- Powell & Kohler
1868. *Powell & Kohler's Practical System for Cutting All Kinds of Garments, Especially Designed for the Use of Dressmakers and Private Families.* Cincinnati: Powell & Kohler.
- Queen, James, and William Lapsley
1809. *The Tailors' Instructor, or A Comprehensive Analysis, of the Elements of Cutting Garments, of Every Kind . . .* Philadelphia: Privately printed. [The authors' revision of the 1796 London publication by the Society of Adepts.]
- Repository of Arts, Literature, Commerce, Manufactures, Fashions and Politics* (Apr 1810), volume 3(17); (Jul 1814), volume 12(67). [Published by R. Ackermann.]
- S. T. Taylor Co. See Taylor, S. T., Co.
Smith, A. Burdette
1877–1888. *Catalogue of A. Burdette Smith's Patterns* (Fall and Winter). New York: Privately printed.
- Society of Adepts in the Profession
1796. *The Tailor's Complete Guide, or a Comprehensive Analysis of Beauty and Elegance in Dress, Containing Rules for Cutting All Garments of Every Kind . . .* London: Society of Adepts in the Profession. [Reported in Giles (1887:79–87), who felt this was the first work on a cutting technique for tailors to be published in England. No evidence to refute his opinion has been found. Although the unorganized and vague characteristics of the directions disqualify this 1796 method from being called a system, the publication serves as proof that there was a desire or need for precise cutting procedures. This work was used by Queen and Lapsley as the basis for their 1809 Philadelphia publication.]
- Stern Brothers' Catalogue* (Spring and Summer 1898), number 92.
- Stone, Charles J.
1901. *New Superlative System of Cutting Ladies' Garments Based upon a Scientific, Sure, and Simple Method.* Chicago: The Chas. J. Stone Co. Cutting School.
- Tabart & Co.
1804. *The Book of Trades.* London: Tabart & Co. [First American edition published by Jacob Johnson, Philadelphia, 1807.]
- Taylor, S. T.
1875. *A System for Cutting Ladies' Dresses, Invented by S. T. Taylor . . .* New York: Sarah E. Taylor.
1877. *A System for Cutting Ladies' Garments, Invented by S. T. Taylor . . .* New York: Sarah E. Taylor.
1896. *S. T. Taylor's System of Dress Cutting.* New York: S. T. Taylor Co.
Taylor, S. T. Co.
1911. *Instruction Book with Diagrams for S. T. Taylor's System of Cutting Ladies' Garments.* New York: S. T. Taylor Co.
- Tentler, Aaron
1842. *A New System for Measuring and Cutting Ladies' Dresses, Cloaks, Collars, Capes, Yokes, &c., with an Arithmetical Table, for Which the Author Received a Patent from the United States, January 23, 1841.* Philadelphia: Privately printed.
- U.S. Bureau of Census
1883. Report on the Manufactures of the United States. *10th Census, 1880*, volume 2.
1895. Report on Manufacturing Industries in the United States. *11th Census, 1890*, volume 6, part 2.
1902. *Manufactures, 12th Census, 1900*, volumes 8, 9.
1913. *Manufactures, 1909. Thirteenth Decennial Census: 1910*, volumes 8, 10.
1923. *Manufactures, 1919. Fourteenth Decennial Census: 1920*, volumes 8, 9.
- U.S. Patent Office [All U.S. patents cited herein are listed in Appendix III.]
1847. *List of Patents for Inventions and Designs Issued by the United States from 1770 to 1847 . . . Compiled and Published under the Direction of Edmund Burke, Commissioner of Patents.* Washington: Printed by J. & G. S. Gideon. [Known popularly as "Burke's 1847 Index"; microfilm copy in U.S. Archives.]
- Vienna Ladies' Tailoring Institute
1905? *Artistic Ladies' Tailor System.* New York: Vienna Ladies' Tailoring Institute.
- Waller, T.
1747. *A General Description of All Trades Digested in Alphabetical Order: by Which Parent, Guardians, and Trustees, May with Greater Ease and Certainty, Make Choice of Trades Agreeable to the Capacity, Education, Inclination, Strength, and Fortune of the Youth under Their Care.* London: T. Waller.
- Waugh, Norah
1964. *The Cut of Men's Clothes 1600–1900.* London: Faber and Faber.
1969. *The Cut of Women's Clothes 1600–1930.* New York: Theatre Arts Books.
- Williams, D.
1842. The Columbian System, for Cutting Garments, Regulated Strictly by Measurement, &c. *The Tailors' Magazine*, 4:37–57.
- Wilson, James A.
1880. *The Science of Dress Cutting by the Wilson Method of Inch Measurement.* San Jose: Privately printed.
- Wilson, James G.
1827. *Report of the Present Fashions, with the Square Rules and Variations to Fit the Human Shape.* New York: Privately printed.
- Zenith Manufacturing Co.
1904. *Instructions for Using Zenith Impression System of Garment Drafting.* Rochester: Zenith Manufacturing Co.

Index

(References to figure numbers in italics)

- Ackermann's Repository of Arts*. See *Repository of Arts*
Adjustable drafting tools for dressmakers, 2, 35, 53–68, *24a*,
25, *26*, *39a,b*, *40*, *44*
Agents for dressmakers' drafting systems: discussed, 77–80,
52, *54*; mentioned, 74, 85
"Age of Enlightenment," 6
Alabama, Montgomery, 91
Amateur sewer. See Dressmaker, amateur
"The American Delineator," 27
"The American Dress Chart," 31
Antoinette, Marie, 13
Apportioning, 74
Apportioning scale: discussed, 33, 35, 39, 47, 50, 53, *36*, *48c*;
mentioned, 2
Apprentice: tailor's, 4, 8; dressmaker's, 20
"L'Art du tailleur," 2, 4, 8, 9
- B. Altman & Co., 9, 65
Basques: defined, 3; mentioned, 49, 50, 53, 55, 71, 81, 88, 99,
31, *55*, *59*, 65
Bayne, J. Reid, 50–53, 37
Bazar Cut Paper Patterns, 85–86, 62. See also McCall, James
Bellas Hess & Co. Catalogue, 67
Bias scales, 33
Le Bon Ton, 2, 21, 44. See also Taylor, S. T.
"Bon Ton Dress Chart," 33
The Book of Trades, 3, 11
Buddington, Mr. and Mrs. F. E., 55–68, 44
"Buddington Dress Cutting Machine," 55
Butterick, Ebenezer, 83. See also E. Butterick & Company
- Canada: country, 35, 68; Montreal, 68; Fennels, 79
Canvassers, 79
Carpenter's tools, 2, 6, 16, 21
Chappell, James H., 33
"Chemise de la Reine," 13
Clavé, Justin, 26, 80, 17
Compass, 31
"Conformateur and System Metrique," 47
Copyright, 2–3, 75
"Coraco Eugenie," 14
Cornwell, Willett, 1, 24, 75, 77, 79–80, *49a,b*, 50
Couturière, maîtresse, 3, 11–12, 8, 9. See also Measure, used by
maîtresse couturière
Covert. See Russel & Covert
Cox & Minton, publishers of "American Dress Chart," 31, 20
Curtis, Ellen Louise, 74. See also Demorest, Madame
Curved edged dressmaker's drafting tools, 2, 31, 33, 35, 39, 47,
50, *53*, *54*, *65*, *75*, *21*, *22a,b*, *32*, *33*, *35*, *36*, *37*, *39a,b*, *40*,
41a,b, *42a–c*, *43a–d*, *44*, *48c*, *49a,b*
Curved ruler, 32
Curves: aids for drawing, 31–32; French, 31
Curve scale, 74
- "Curve Scale," 48c
Cutter, 3, 4, 30, 91–93, 100, *43c*
Cutting, 3
- da Vinci, Leonardo. See Vinci, Leonardo da
Demorest, Madame: person, 74, *51*, *55*; drafting system, 77,
80–81, 83; patterns, 81–83, 90, 99, *56*, *57*. See also *De-*
morest's Monthly Magazine; *Mme. Demorest's Quarterly Mirror of*
Fashion; *Mme. Demorest's What to Wear*
Demorest, William J., 74. See Demorest, Madame
Demorest's Illustrated Monthly. See *Demorest's Monthly Magazine*
Demorest's Monthly Magazine, 81, 51
Description of All Trades, 4, 11
"Developing Pattern," 32
Discourses on the Fine Arts, 7
"Dress Chart," 35
"Dress Cutting Machine," 35, *24a,b*. See also Plant, John B.
Dressmaker: discussed, 74, 77, 79, 80, *34*, *38*, *43c*, *52c*; male, 85.
See also Apprentice; Carpenter's tools; Couturière, maî-
resse; Dressmaking; Mantua-maker; Seamstress
Dressmaking. See also Couturière, maîtresse; Dressmaker
—amateur, 1, 2, 80–81, 90, 93, 103
—professional: trade, 1, 2, 16–20, 45, 74, 103, *Frontispiece*, 11,
31, *38*, *55*, see also Dressmaker, Fashion changes, Pin-to-the-
form; use of drafting system, 1, 20, 25, 45, 80, 81, 90–93,
101–102, 103; tools other than specialized drafting tools, see
Curves, Patterns, Tape measure, Tracing wheel, Yardstick
Dress Making Reduced to a Science; *The Eclectic Lady-Tailor System of*
Dress Cutting, 50
"Dress Model," 51
Duncan, Lillian, 55, 91, *43a–d*. See also "McDowell Garment
Drafting Machine"
Duval, Marie E., 90. See also "Dress Cutting Machine"
- E. Butterick & Company, 83–85, 90, 99, 58, 59, 60
Eckhart, Emma, 55, 90, 63
The Eclectic Lady-Tailor System of Dress Cutting, 31. See also Malli-
son, Mme. E. W.
1876 International Exhibition, 77, 83, 28, 50, 51
Elliptic Sewing Machines, 85
Empire style, 13
"Emporium of Fashions," 51, 55. See also Demorest, Madame
England: country, 3, 4, 6, 7, 18, 21, 30; London, 7, 85; Man-
chester, 85
"Excelsior Square," 36. See also Phelps, Brigham Thomas
- Fashion changes: effects on tailor's trade, 6, 41; effects on
dressmaking trade, 12, 13, 16–18, 45, 93; creating need for
dressmakers' drafting systems, 20, 35, 99, 101; effects on
dressmakers' drafting systems, 28–30, 35, 44, 54, 55, 75, 80,
81, 100, 102, 103; effects on ready-made industry, 98, 67
Fashion plates, 13–16, 18, 5, 10, 12, 13, 30
Fitter, 68

- Follett, Edward P., 74. *See also* Zenith Manufacturing Company
- Fowler, creator of early system, 21–24, 25
- Fowler, Abraham, 24
- Fowler, Henry, 24
- Fowler, James, 24
- Fowler, John, 24
- Fowler, Lorenzo Niles, 24
- Fowler, Lydia Folger, 24
- Fowler, Mahlon, 24
- Fowler, O.S. & L.N., 25
- Fowler, Orson Squire, 24–25
- Fowler, Rennels, 24
- Fowler, Simeon L., 24
- Fowler, William, 24
- Fowler and Wells, 24, 25
- Fowler's Theorem, 24, 25
- France: country, 7, 68; Paris, 13, 44, 68, 85, 30
- Frazier, Mrs. H. L., 91
- French curves, 31. *See also* Curves
- French dressmakers, 74
- Garsault, M. de, 3, 12, 2, 4, 8, 9
- Gartland, Elizabeth, 45
- Giles, Edward B., 31
- Godey, Louis A., 13
- Godey's Lady's Book*, 2, 13, 16, 20, 80–81, 13, 14
- Greece, Athens, 7
- Guilds, 3
- Hand tailor's tool, 31
- Harper's Bazar*, 77, 85, 52
- Harroun, Elmira, 75. *See also* Cornwell, Willett
- Hearn, Mr., creator of early tailors' drafting systems, 9
- Hecklinger, Charles, *Frontispiece*
- Herculaneum, 7
- Home sewer. *See* Dressmaking, amateur
- Horse shoes, 31
- Howe, Elias, Jr., 61. *See also* Sewing machine
- How to Cut and Make Ladies' Garments*, *Frontispiece*
- Illinois, Chicago, 74, 99, 102
- Immigrants, 20
- "Impression System," 48a–c
- "Improved Dress Cutting Machine," 68. *See also* Buddington, Mr. and Mrs. F. E.
- Indentures, 4
- Indiana: Danville, 31, 20; Richmond, 47, 32
- Inwood, Mrs. D. A., 77–78
- Italy, 7
- Jackson, Andrew, 99
- Jackson, Louisa L., 47, 75, 32, 33
- Kansas, Topeka, 33, 22a,b
- Kohler. *See* Powell & Kohler
- The Ladies' Hand Book*, 80
- Ladies' Report of New York Fashions*, 83
- The Lady's Book*. *See* *Godey's Lady's Book*
- The Lady's Magazine*, 12
- Lapsley, William. *See* Queen, James, and William Lapsley
- Le Brun, Vigée, 13
- Lemmond, William J., 7
- Library of Congress, v, vi, 2–3, 33, 99, 101, 68
- Lindsay, James, 57
- Lord & Taylor, 98, 64
- Louis XIV, 3, 7
- Louisiana, New Orleans, 68
- McCall, James, 85–86, 61, 62
- McDowell, Albert, 53, 54–55, 91, 100, 39a,b, 41a,b, 42a–c, 43c.
See also McDowell & Co., A.; "McDowell Garment Drafting Machine"; "McDowell Sleeve Machine"
- McDowell & Co., A., 53, 65, 66, 74, 75, 77, 91, 101, 38, 47, 52, 63. *See also* McDowell, Albert; "McDowell Garment Drafting Machine"; "McDowell Sleeve Machine"
- "McDowell Garment Drafting Machine," v, 53–55, 66, 71, 77, 90, 101, 38, 42a,b, 43a,d, 52. *See also* McDowell, Albert; McDowell & Co., A.
- McDowell Garment Drafting Machine Co. *See* McDowell & Co., A.
- "McDowell Sleeve Machine," 55, 90, 42c, 43b
- McMillen, Mrs. H., 27–28, 18
- Madison, Otis, 9
- Mail order: custom made clothing, 91–93; ready-made clothing, 98
- Maine, Biddeford, 35, 39, 24a,b
- Maitresse couturière. *See* couturière, maitresse
- Mallison, Mme. E. W., 47–49, 90, *Frontispiece*, 31, 34
- "Man of Perfect Proportion," 7
- Mantua: defined, 3–4; mentioned, 12
- Mantua-maker, 3–4, 12, 13. *See also* Dressmaker; Mantua-making trade
- Mantua-making trade, 2, 11–13. *See also* Dressmaking, professional; Mantua-maker
- Markley & Son, manufacturer of dressmakers' drafting system, 33–35, 22a,b, 23
- Massachusetts: Lawrence, 33, 21; Leominster, 83; Sterling, 83; Indian Orchard, 90; Boston, 99, 102, 55
- Measure: used by tailor, 4–6, 7, 8; used by maitresse couturière, 11. *See also* Strips; Tape measure
- Measure book, 90, 28, 36, 40, 63
- "Measurer," 71, 48a
- Measuring tape. *See* Tape measure
- The Metropolitan*, 83. *See also* E. Butterick & Co.
- Milliners, 79
- Minier, Dr. E. P., 21, 41, 77
- Minister, Edward, 9, 30
- Minton. *See* Cox & Minton
- Mirror of Fashion*, 32
- Mme. Demorest's Quarterly Mirror of Fashion*, 16, 81, 15a,b. *See also* Demorest, Madame
- Mme. Demorest's What to Wear*, 83. *See also* Demorest, Madame
- Moschcowitz, Herman, 85–86
- Moschcowitz, Schamu, 85–86
- Mosher, C. E., 33, 35, 75, 21
- Naval architect, compared to dressmaker, 16–18
- New England states, 68
- "New Geometrical Method," 26
- New Jersey, Jersey City, 57
- New York: New York, 21, 24, 39, 44, 53, 75, 77, 83, 85, 99, 102,

- 27a-c; Rochester, 71, 48a-c, 54; Brooklyn, 43d; Elmira, 53
 Noland, Joseph H., 32, 50
 Norman, Nancy and George, 75
- Ohio: Cincinnati, 21, 30, 77, 19a,b; Clyde, 27, 18
- P. S. Duval & Son, 26
 Palmer, Mrs. E. E., 74-75
 Patents. *See* United States Patent Office
The Patent Transfer System, 33
 Pattern diagrams, 16, 18
 "Pattern Marker," 68, 45
 Patterns: used by tailors, 4, 7, 8, 31; used to cut ready-made clothing, 8, 100; not used by *Maitresse couturière*, 11; made by pin-to-form technique, 13; made from used lining, 13, unsized, 16, 18, 44-45, 81, 99, 15a,b, 54, 55; drafted by dressmakers' system, 26, 28, 30, 31, 35, 54, 55, 68, 71, 74, 81, 86-88, 91, 31, 55; massproduced sized, 81-90, 93, 99, 102, 103, 104, 51, 56, 57, 58, 59, 60, 62
 Pennsylvania: Philadelphia, 20, 21, 24, 25, 26, 77, 99, 102, 17, 45, 46, 51; Allentown, 90, 63; Aquaschicola, 90; Bowmanstown, 90; Carbon, 90; Lehighton, 90; Little Gap, 90
 Perforated drafting tools, 2, 24, 26, 28, 30, 31, 33, 35, 39, 47, 74, 75, 80, 83, 85, 16a-c, 17, 18, 20, 22a,b, 23, 24a,b, 32, 33, 49a,b, 51
Peterson's Magazine, 13, 16, 86
Le Petit Messenger, 44. *See also* Taylor, S. T.
 Peyry, Jean B., 68-71, 47
 Phelps, Brigham Thomas, 50, 53, 36
 Phrenology, 24
 Pin-to-the-form, 13, 16, 18, 93, 11
 Pingat, E., 85
 Plant, Harry N., 39
 Plant, John B., 35-39, 90, 24a,b, 25, 36
 Pollard, A. W., 83. *See also* E. Butterick & Co.
 Pollock, William Bloomer, 68, 46
 Pompeii, 7
 Poole, Margaret Willamina, 74. *See also* Demorest, Madame
 Powell & Kohler, creators and manufacturers of dressmakers' drafting systems, 20, 30, 31, 41, 75, 19a,b
 Pre-Tentler system, 21-25, 28. *See also* Tentler, Aaron A.
 Proof measurements, 8, 26, 30
 Proportionable scale, 7, 8
 Proportional theories: used by tailors, 7-9; used in drafting systems for dressmakers, 21, 24, 28, 30, 31; applied to ready-made clothing for women, 98
- Queen, James, and William Lapsley, 6, 7, 9
- Ready-made clothing: discussed, 100; men's, 8, 94, 102, 103; women's, 80, 94-98, 102-103, 104, 65, 66a, 67; mentioned, 83, 57
Repository of Arts, 5, 10
 Reynolds, Sir Joshua, 7
 Rhode Island, Pawtucket, 35
 Roorbach, O. A., 85
 Royal Academy, 7
 "The Royal Chart," 85, 61. *See also* McCall, James
 "Ruler for Cutting Out Garmets," 9
 Russell, partner of Moschowitz brothers, 85
 Russell & Covert, seller of McCall's drafting system, 85
- S. T. Taylor Company, 41, 45. *See also* Taylor, S. T.
 "S. T. Taylor's System of Dresscutting," 45. *See also* Taylor, S. T.
 "Scale for Draughting Garments," 9
 School teachers, 79
 Scotland, Glasgow, 85, 61
 Seamstress, 1, 3, 4, 20, 81
 "Self-Fitting System," 75, 49a,b. *See also* Cornwell, Willett
Semi-Annual Report of Gentlemens' Fashions, 83. *See also* E. Butterick & Co.
 Sewing machine, 20, 79, 80, 85, 31, 53, 61
 Singer, Isaac M., 20. *See also* Sewing machine
 Sizing systems, 1, 104
 Skirt drafting systems, 35, 71, 93, 25
 Sleeve drafting systems, 25, 35, 49, 50-53, 55, 71, 75, 23, 26, 42c
 Slop makers, 7, 8
 Smith, A. Burdette, 86-88
 Society of Adepts, 6, 9
 Squares: incorporated into dressmaker's drafting systems, 2, 39, 41, 49, 50-53, 103, 28, 29, 34, 35, 36, 37, 38, 40, 43d; tailor's, 9, 6, 7. *See also* Carpenter's tools
 Starr, N. B., 9
Stern Brother's Catalogue, 66a,b
 Stone, Charles [John], 93
 Strips: used as part of drafting tool, 2, 30, 41, 19a,b, 28, 29; used for measuring, 24, 27. *See also* Measure; Tape measure
 Suits, women's, 93
- Tabart & Co., 11
 Tailleur, 3
 Tailor: ladies, 93; mentioned, 83. *See also* Apprentice; Tailoring
 Tailoring: trade, 2, 3, 4-6, 7-8, 9, 20-21, 31, 33, 93, 1, 2, 3, 4, *see also* Proportional theories; drafting systems, 2, 7-9, 74, 98, 6, 7; effect of drafting systems on dressmaker's drafting systems, 9, 20-21, 24, 41, 45; tools other than specialized drafting tools, *see* Compass, Curves, Hand tailor's tool, Horse shoes, Measure, Patterns, Squares, Tape measure, Yardstick
 Tape measure: used by tailor, 2, 7, 8, 9, 7; used by dressmakers 16, 24, 86, 62; used by dressmaker as part of a drafting system, 47-49, 53, 68, 71, 74, 86, 101, 24b, 34
 Taper scale, 35
 Taylor, S. T., 2, 21, 39-45, 77, 80, 91, 28, 29, 54. *See also* *Le Bon Ton*; *Le Petit Messenger*; S. T. Taylor Co.; "S. T. Taylor's System of Dressmaking"
 Tentler, Aaron A., 21, 25-26, 28, 31, 16a-c. *See also* Pre-Tentler
 Tracing wheel, 43d
 Trade cards, 78, 80, 53, 54, 55, 57
 Trade exhibitions, 75-77
- United States Circuit Court, District of Indiana, 75
 United States Patent Office: patents for drafting systems, 2, 3, 75, 99-101, 6, 7, 16a-c, 32, 36, 39a,b, 41a,b, 42a-c, 45, 46, 69; mentioned, v
- Vermont, Bellows Falls, 50, 36
 Vienna Ladies Tailoring Institute, 39, 27a-c
 Vinci, Leonardo da, 7
- "W. Cornwell's Chart," 49a. *See also* Cornwell, Willett

- Washington, D.C., 47, 91, 34
 Wells, Charlotte Fowler, 25
 Wells, Samuel Roberts, 25
 Wickersham, Angeline P., 68, 45
 Wilder, J. W., 83. *See also* E. Butterick & Co.
 Wilson, James A., 50, 53, 75, 35
 Wilson, James G., 9, 21, 30, 6
 Wisconsin, Baraboo, 74
 Women: education, 2; employment, 18-20, 77-78, 79, 81. *See also* Agents for dressmaker's drafting systems; Dressmaker;
 Couturière maitresse; Canvasser; Mantua-maker; Milliners;
 School teachers; Seamstress
The Women's Book, 90
 Woodward and Lothrop, 91
 Worth, Charles Frederick, 85
- Yardstick, 6, 16
- Zaun, Annie C., 91
 Zenith Manufacturing Company, 71-74, 48a-c

REQUIREMENTS FOR SMITHSONIAN SERIES PUBLICATION

Manuscripts intended for series publication receive substantive review within their originating Smithsonian museums or offices and are submitted to the Smithsonian Institution Press with approval of the appropriate museum authority on Form SI-36. Requests for special treatment—use of color, foldouts, casebound covers, etc.—require, on the same form, the added approval of designated committees or museum directors.

Review of manuscripts and art by the Press for requirements of series format and style, completeness and clarity of copy, and arrangement of all material, as outlined below, will govern, within the judgment of the Press, acceptance or rejection of the manuscripts and art.

Copy must be typewritten, double-spaced, on one side of standard white bond paper, with 1¼" margins, submitted as ribbon copy (not carbon or xerox), in loose sheets (not stapled or bound), and accompanied by original art. Minimum acceptable length is 30 pages.

Front matter (preceding the text) should include: **title page** with only title and author and no other information, **abstract page** with author/title/series/etc., following the established format, **table of contents** with indents reflecting the heads and structure of the paper.

First page of text should carry the title and author at the top of the page and an unnumbered footnote at the bottom consisting of author's name and professional mailing address.

Center heads of whatever level should be typed with initial caps of major words, with extra space above and below the head, but with no other preparation (such as all caps or underline). Run-in paragraph heads should use period/dashes or colons as necessary.

Tabulations within text (lists of data, often in parallel columns) can be typed on the text page where they occur, but they should not contain rules or formal, numbered table heads.

Formal tables (numbered, with table heads, boxheads, stubs, rules) should be submitted as camera copy, but the author must contact the series section of the Press for editorial attention and preparation assistance before final typing of this matter.

Taxonomic keys in natural history papers should use the aligned-couplet form in the zoology and paleobiology series and the multi-level indent form in the botany series. If cross-referencing is required between key and text, do not include page references within the key, but number the keyed-out taxa with their corresponding heads in the text.

Synonymy in the zoology and paleobiology series must use the short form (taxon, author, year:page), with a full reference at the end of the paper under "Literature Cited." For the botany series, the long form (taxon, author, abbreviated journal or book title, volume, page, year, with no reference in the "Literature Cited") is optional.

Footnotes, when few in number, whether annotative or bibliographic, should be typed at the bottom of the text page on which the reference occurs. Extensive notes must appear at the end of the text in a notes section. If bibliographic footnotes are required, use the short form (author/brief title/page) with the full reference in the bibliography.

Text-reference system (author/year/page within the text, with the full reference in a "Literature Cited" at the end of the text) must be used in place of bibliographic footnotes in all scientific series and is strongly recommended in the history and technology series: "(Jones, 1910:122)" or ". . . Jones (1910:122)."

Bibliography, depending upon use, is termed "References," "Selected References," or "Literature Cited." Spell out book, journal, and article titles, using initial caps in all major words. For capitalization of titles in foreign languages, follow the national practice of each language. Underline (for italics) book and journal titles. Use the colon-parentheses system for volume/number/page citations: "10(2):5-9." For alignment and arrangement of elements, follow the format of the series for which the manuscript is intended.

Legends for illustrations must not be attached to the art nor included within the text but must be submitted at the end of the manuscript—with as many legends typed, double-spaced, to a page as convenient.

Illustrations must not be included within the manuscript but must be submitted separately as original art (not copies). All illustrations (photographs, line drawings, maps, etc.) can be intermixed throughout the printed text. They should be termed **Figures** and should be numbered consecutively. If several "figures" are treated as components of a single larger figure, they should be designated by lowercase italic letters (underlined in copy) on the illustration, in the legend, and in text references: "Figure 9_b." If illustrations are intended to be printed separately on coated stock following the text, they should be termed **Plates** and any components should be lettered as in figures: "Plate 9_b." Keys to any symbols within an illustration should appear on the art and not in the legend.

A few points of style: (1) Do not use periods after such abbreviations as "mm, ft, yds, USNM, NNE, AM, BC." (2) Use hyphens in spelled-out fractions: "two-thirds." (3) Spell out numbers "one" through "nine" in expository text, but use numerals in all other cases if possible. (4) Use the metric system of measurement, where possible, instead of the English system. (5) Use the decimal system, where possible, in place of fractions. (6) Use day/month/year sequence for dates: "9 April 1976." (7) For months in tabular listings or data sections, use three-letter abbreviations with no periods: "Jan, Mar, Jun," etc.

Arrange and paginate sequentially EVERY sheet of manuscript—including ALL front matter and ALL legends, etc., at the back of the text—in the following order: (1) title page, (2) abstract, (3) table of contents, (4) foreword and/or preface, (5) text, (6) appendixes, (7) notes, (8) glossary, (9) bibliography, (10) index, (11) legends.

