



Water Current Meters

IN THE SMITHSONIAN COLLECTIONS OF THE
NATIONAL MUSEUM OF HISTORY AND TECHNOLOGY

Arthur H. Frazier



SMITHSONIAN INSTITUTION

SMITHSONIAN STUDIES IN HISTORY AND TECHNOLOGY / NUMBER 28

Water Current Meters

IN THE SMITHSONIAN COLLECTIONS OF THE
NATIONAL MUSEUM OF HISTORY AND TECHNOLOGY

Arthur H. Frazier

ISSUED
DEC 30 1974



SMITHSONIAN INSTITUTION PRESS

City of Washington

1974

ABSTRACT

Frazier, Arthur H. Water Current Meters in the Smithsonian Collections of the National Museum of History and Technology. *Smithsonian Studies in History and Technology*, number 28, 95 pages, 94 figures, 1974.—Water current meters are the basic instruments used in connection with stream gaging, the art of measuring and maintaining a continuous record of the volume, in cubic feet (or cubic meters) per second, of water flowing in rivers. The history of both that art and these instruments forms a large part of this study. The contributions of men like Marcus Vitruvius, Hero of Alexandria, Leonardo da Vinci, Benedetto Castelli, Sir Isaac Newton, and a large group of eminent modern hydrographers are discussed.

Special attention is given to the type of current meters built for use on rivers such as those in the collection of the Smithsonian Institution. It does not include meters of the type featured in the collection at the Institut Oceanographique, Musée de Monaco, most of which were developed especially for measuring ocean currents. Whenever possible, the men responsible for introducing each new design are also discussed.

OFFICIAL PUBLICATION DATE is handstamped in a limited number of initial copies and is recorded in the Institution's annual report, *Smithsonian Year*. SI PRESS NUMBER 4968.

Library of Congress Cataloging in Publication Data

Frazier, Arthur H.

Water current meters in the Smithsonian collections of the National Museum of History and Technology.

(Smithsonian studies in history and technology, no. 28.)

Supt. of Docs. no.: SI 1.28:28.

Bibliography: p.

1. Water current meters—History. 2. U. S. Museum of History and Technology. I. Title. II. Series. Smithsonian Institution. Smithsonian studies in history and technology, no. 28. TC175.F76 551.4'83'028 74-5425

For sale by the Superintendent of Documents, U.S. Government Printing Office
Washington, D.C. 20402 - Price \$2.05
Stock Number 4701-00116

Preface

There has always been a close and cordial relationship between the Geological Survey and the Smithsonian Institution. Clarence King, the Survey's first director (1879-1881), received Smithsonian aid for his famous *U.S. Geological Exploration of the Fortieth Parallel*—the first systematic reconnaissance of that vast unmapped area of this country between the 105th and 120th meridian. John Wesley Powell, the Survey's second director, whose two trips through the Colorado Canyon brought him everlasting fame, conducted several investigations between 1871 and 1874 with funds from Congressional appropriations stipulating that the work be performed "under the direction of the Smithsonian Institution." After those (and later) investigations were completed, the Smithsonian Institution established a Bureau of American Ethnology, with Powell in charge thereof. Just one year later, he assumed the directorship of the Geological Survey and for many years handled both positions at his office in the Smithsonian Institution building. The third director of the Geological Survey was Charles Doolittle Walcott who, after serving from 1894 to 1907 as director of the Survey, became the Secretary of the Smithsonian, a position which he held until his death in 1927. For about one year before receiving the Smithsonian appointment, he divided his time between those two organizations, serving then as the Acting Assistant Secretary of the Smithsonian in Charge of the National Museum.

Much of the information in this study was made available to the writer while employed in the Water Resources Division of the United States Geological Survey, an organization where current meters are as essential to its field engineers as a trowel is to a mason, or a plow is to a farmer. To the late Nathan C. Grover, Carl G. Paulsen, and John C. Hoyt, and to many of those others still living who guided my work in that agency and who encouraged my desire to delve into the history of current meters and stream-gaging methods, I am deeply grateful.

John Clayton Hoyt (1874-1946) was employed by the Geological Survey in 1902, and served that agency until his retirement in 1944. During parts of those 42 years, he held the positions of Assistant Chief Hydrographer and Chief, Surface Water Division. Among his many interests was the improvement of current meters and the preservation of many of the early models. His early association with Walcott was conceivably a major influence in his having transferred several of those early meters (as soon as they achieved historical significance) to the Smithsonian Institution. Among them were several of the meters that had been used in the late 1880s by the U.S. Irrigation Survey, and the original models of both the Large and the Small Price current meters, which form the very foundation of the Smithsonian's fine collection. For John Hoyt's personal friendship and shining example, I have a deep sense of gratitude.

I also wish to express my gratitude for the help given me by staff members of the Library of Congress, the Library of the universities of Wisconsin, Ohio State, and especially Iowa State, the latter of which houses the fine "HHT" collection sponsored by Dr. Hunter Rouse, who provided much valuable data for this study.

For much of the information regarding the early stream-gaging activities in foreign lands, I am particularly indebted to the late Professor Steponas Kolupaila of Notre Dame University, and to Dr. Carlo Zammattio of Trieste, Italy. For much

of the information regarding William Gunn Price and the early Price current meters, I am equally indebted to his own grandson, W. G. Price of New Cuyama, California, and to the late Charles E. Smart who, for many years had been Chairman of the Board in the W. & L. E. Gurley firm of Troy, New York.

My sincere thanks are due to present members of the staff of the National Museum of History and Technology, Smithsonian Institution, in which the current meter collection is presently housed, and especially to its former director, Robert P. Muthauf, who encouraged me to undertake this study; to Jack Goodwin and Charles Berger of the museum's library, who helped me locate many of the books for which I felt a need; to George Norton, who arranged that I be furnished with photographs of the meters in the collection; and finally to Jon Eklund, who helped in so many ways while I was preparing this study.

Contents

	<i>Page</i>
Preface	iii
Introduction	1
Ancient Concepts	2
Emergence of Modern Hydrometric Methods	6
$Q=A$ vs $Q=AV$	6
Free Floats	8
Tethered Floats.	15
Paddles	18
Paddle Wheels	21
European Contributions	22
American Innovations	28
Tubing Applications	33
The Pitot Tube	33
The Bentzel Velocity Tube	35
The Venturi Tube	37
The Longitude Contest	41
De Saumarez' Ships' Logs	41
The Log with a Vertical Axis	41
The Log with a Horizontal Axis	43
Administrative Strategy, 1716 Style	46
Horizontal-Axis Meters	48
Early European Developments	48
Robert Hooke	48
Reinhard Woltman	49
Julien John Révy	50
Joseph Saxton	51
The Baumgarten Meter	56
Other American Models	63
Hall's Current Meters	63
The Haskell Current Meter	64
U.S. Irrigation Survey Models	66
Other European Developments	67
Moore's Current Meter	67
The Firm of A. Ott	68
Steponas Kolupaila	69
Vertical-Axis Meters	72
The Henry Meter	73
The Ellis Meters	74
The Nettleton Meter	75
The Price Meters	78
Notes	87
Literature Cited	88
Index	92

Water Current Meters

Arthur H. Frazier

INTRODUCTION

A primary purpose of this study is to present a catalog of the water current meters in the Smithsonian Institution's National Museum of History and Technology, the largest collection of its kind in the world. It is also intended to present background information that will provide the reader with an understanding of where each current meter in the collection (and its designer) fits into the general historical setting relative to such instruments. The illustrations of current meters, for which accession numbers (NMHT) are noted, represent the present collection of such instruments in the Smithsonian Institution.

Water current meters (referred to hereafter as "current meters" or simply "meters") are instruments used for evaluating the amount and velocity of water at one or more points in a flowing stream at any particular moment in time. The amount of water is measured in cubic feet per second, whereas the velocity is determined in feet per second.

In America, the United States Geological Survey publishes in its *Water-Supply Papers*, the daily averages of the flow at almost 9000 "gaging stations" throughout all of the States. The following are just a few of the important uses made of such streamflow records:

DAMS.—Dams are built for water-supply purposes, hydroelectric power, flood control, irrigation, navigation improvement, recreation lakes, and a host of other purposes. In each instance, a careful study of all pertinent streamflow records must be made well

Arthur H. Frazier, 3636 Sixteenth Street, N. W., Washington, D.C. 20010. Honorary Research Associate, Smithsonian Institution.

in advance of any construction work to determine whether the drainage area above the selected site would yield a sufficient amount of water to accomplish the purpose for which the dam is intended, and to determine the amount of water that is likely to flow there under the maximum flood conditions. Inadequate spillway capacities constitute the major causes of dam failures. Therefore, a vital requirement in the design of any proposed dam is that its spillway capacity will be adequate to accommodate the largest probable flood.

LITIGATIONS.—Litigations involving uses of water have occurred ever since the advent of written history. In *A History of Technology* edited by Charles A. Singer, et al., one finds that the words "rivers" and "rivals" stem from the same source. "That very word 'rivals' in Roman law denoted those who shared the water of a rivus, or irrigating channel; it thus implies jealously guarded rights and frequent quarrels."¹

In modern societies, perhaps the most equitable method yet devised for settling such disputes has been by means of court decisions that allot certain amounts or proportions of the available water to each litigant who has a legitimate right to it. Water masters are appointed to carry out these court orders. In almost all instances the masters base the distribution on discharge data procured through the use of current meters. Thus again we see that the reliable evaluation of discharge data is essential.

PUBLIC HEALTH.—Today streams are often polluted by untreated sewage, manufacturing wastes, modern detergents, and dangerous chemicals, with a consequent destruction of fish and wild life. A large

percentage of attractive recreational waters and city water supplies have consequently been withdrawn from public use. Conservation officials and public health officials at all levels of government are deeply concerned about those conditions, particularly during periods of drought, when streams are low and the consequent percentage of pollution is exceptionally high. Streamflow records indicating the approach, arrival, intensity, and passage of these periods provide important information on which such officials can make appropriate administrative decisions.

HIGHWAY BRIDGES AND CULVERTS.—The intelligent design of bridges and culverts for the vast network of highways across the nation depends on the availability and adequacy of streamflow records. Without such records, these structures might be built too large, resulting in excessive cost, or too small, thereby endangering the road in times of severe floods.

Although this list could be greatly expanded, these examples are sufficient to indicate the importance of such records in relation to modern engineering and humanitarian problems.²

ANCIENT CONCEPTS

Although legends and archeological investigations have extended our knowledge of man's involvement with flowing water farther into the past than has written history, only two *written* records about it have survived from ancient times. The first is in Section 53 of the famous Code of Hammurabi (Figure 1) reported in Webster's New International Dictionary (2nd edition) to have been written between 1955 and 1913 B.C. It contains the following regulation:

If anyone be too lazy to keep his dam in proper condition, and does not keep it so: If then, the dam breaks and all the fields are flooded, then shall he in whose dam the break occurred be sold for money and the money shall replace the corn which he has caused to be ruined.³

The second of those records was found among the ruins of a temple which the Pharaoh Akhenaten (the older brother of Tutankhamun) built in about 1400 B.C. at Tell 'Armarna, Egypt, in honor of the god Ra who he had intended would replace Egypt's Pantheon. It consisted of the following inscription proclaiming that his new faith would endure

Until the swan grows black
And the Raven becomes white:
Until the Mountains rise up and walk,
And the waters flow uphill [italics added].⁴

Ditches were the earliest structures devised for the control of water on the great flood plains of rivers like the Nile, Hwang-Ho (Yellow), Tigris-Eurphrates, and Indus. They served two purposes: first, to drain off the excess water after floods, and second, to ir-

rigate the crops during the long dry periods. There were, however, other locations, namely the oases in deserts, where such ditches served only the latter purpose, i.e., irrigation.



FIGURE 1.—Portion of the Code of Hammurabi.
(Courtesy of the Louvre, Paris.)

It is of interest to note in this connection that many desert communities developed essentially the same type of water clock for the sole purpose of limiting the amount of water that each of the farmers in those communities were allowed to take from the irrigation ditches.⁵ The method still in use at the Oasis Ghadames in Western Libya, provides an excellent example of one of those clocks and of the procedures that were followed there for the past thirty or more centuries:

At the spring "Ain El Fras" at the Oasis Ghadames, the amount of time the landowners are permitted to draw water for their gardens from the irrigation ditch, has been controlled during the past 3000 years or more by the methods shown here [Figure 2]. At the local marketplace (quite some distance from the ditch) is a shallow well presided over by an attendant who lowers a bucket into the well until it becomes filled with water. Then he raises it, hangs it onto a nearby peg while he makes a record thereof by tying a knot into a fiber from the bark of a palm tree. The water drains back into the well through a hole in the bottom of the



a



FIGURE 2.—Oasis Ghadames: *a, c*, the "water clock" at the market place; *b*, the reservoir at the spring, Ain el Fras; *d*, gardeners diverting the irrigation water. (From Schaack, "Vergangenheit.")



c



d

bucket, and when empty, the procedure is repeated (over and over again day and night, each cycle requiring about five minutes). Each landowner in turn is allowed to divert into his garden, water from the irrigation ditch for the time it takes for the bucket to be filled and emptied a certain number of cycles depending upon the proportion of land he owns in the area. He must be ready to open his water gate at the beginning of the particular series of cycles that are allotted to him, and upon the completion of that series, he must close his gate and allow the water to pass on to the next landowner in line, who will be waiting his turn. Although modern clocks would accomplish the same results with fewer complications, there does not seem to be any inclination to change this ancient practice.⁶

One observation regarding this desert practice merits particular mention here. It is that from time immemorial, these people were acquainted with one of the basic concepts in hydraulics, namely that the amount of discharge taking place in any irrigation ditch (or in any stream of water) is a function of time.

Much more technologically advanced structures devised for the control of water are the famous Roman aqueducts. Although Sennacherib's aqueduct at Jerwan in northern Iraq⁷ is perhaps 400 years older than the first of the Roman aqueducts and ranks among the earliest of such structures, the Roman aqueducts (begun in about 300 B.C.) are of the greater interest here because of the water-measuring facility, the *quinaria*, which is associated with them.

The *quinaria* is a unit of measurement, by which water is apportioned. Apparently first introduced by the Romans, it was defined by a circular *area* about 1¼ "digits" in diameter. Sextus Julius Frontinus, the Water Commissioner of Rome in about A.D. 97 mentioned its origins in his writings:

According to those who ascribe it to Vitruvius and the plumbers, it [the *quinaria*] took its name from the circumstance that a flat sheet of lead, five digits wide, made up into a round pipe, will form this adjutage.⁸

By "adjutage," Frontinus had reference to the pipes that were inserted through the walls of Rome's supply reservoirs through which water was delivered to the conduits of the various consumers. Numerous sizes eventually became available, with each adjutage stamped with the number of *quinariae* present in their respective cross-sections. The consumer, at regular intervals, paid to the State a sum computed by multiplying the unit price of a *quinaria* by the number stamped on his adjutage.

No serious attention was paid to the elevations at

which these adjutages were located in the walls of the reservoirs, nor to any other inequities which could be found with the system. Nevertheless, this is one of the earliest known methods of measuring directly the flow of water. This same erroneous technique was also applied to measuring the flow in open channels. The water master merely measured the wetted cross-sectional area of the channel to determine the number of *quinariae*. He was not concerned as to whether the location of that measurement was at a narrow and shallow, or wide and deep place in the channel. Frontinus himself made a number of such measurements to determine whether the number of *quinariae* flowing into the reservoirs corresponded with the number of *quinariae* delivered to the consumers. When he found that there was an enormous discrepancy, he began to question the honesty of his deputies rather than to question the validity of his stream-gaging methods.⁹

The circumstances just described characterize the state of the art of stream gaging from ancient times forward. Mistakenly based on the concept that the discharge of water is equal to the wetted cross-section of an open or closed channel ($Q=A$), the concept of the discharge of streams as a function of time was not considered. There was at that time, however, one person who took exception to the current theory—Hero of Alexandria.

Hero of Alexandria was a Greek mathematician and mechanic of the first century A.D. His accomplishments, too numerous to list here, are so impressive that one school of thought has contended that he, like Nostradamus, was a mythical character who had been credited with having conceived almost every extraordinary mechanical device then existing. In any event, in his book, *Dioptra*, he described a way to measure the discharge of a spring, which is now known as the volumetric method (Figure 3). This method which has never been surpassed in accuracy, is based on the concept that the area of a channel multiplied by the velocity of flow equals the amount of water passing a given point at a particular moment in time.

Given a spring: To determine its flow, that is, the quantity of water which it delivers . . .

Now, it is necessary to block in all the water of the spring so that none of it runs off at any point, and to construct out of lead, a trough having a rectangular shape. Care should be taken to make its dimensions considerably greater than those of the stream of water. It should then be installed at a

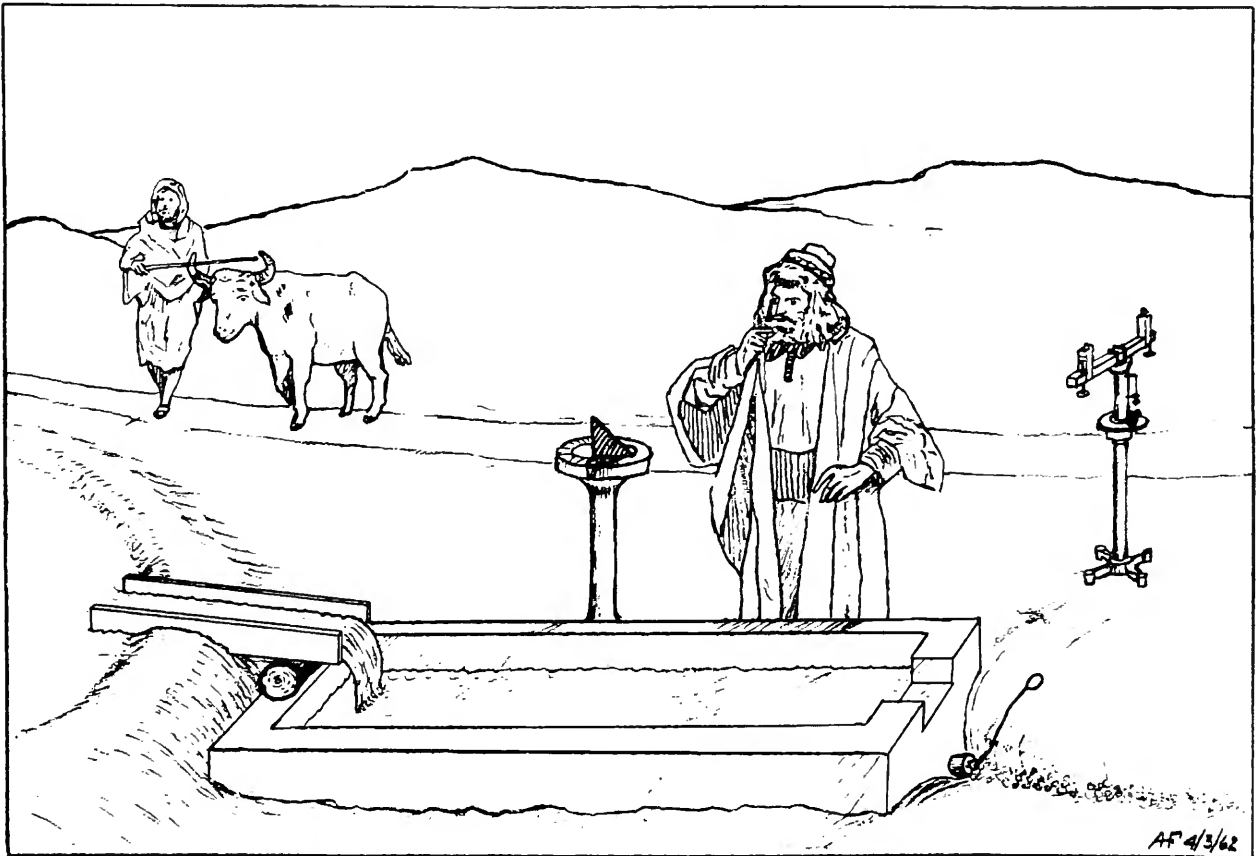

FIGURE 3—The world's first valid streamflow measurement as described by Hero of Alexandria, first century A.D. (Drawn by A. H. Frazier.)

place such that the water from the spring will all flow through it

That water will cover a portion of the cross-section of the trough at its mouth. Let this portion be for example, 2 digits in height. Now suppose that the width of the trough is 6 digits; $6 \times 2 = 12$. Thus the flow of the spring is 12 [square] digits.

It is to be noted that in order to determine how much water the spring supplies, it is not sufficient to merely find the area of the cross-section of the flow, which in this case we say is 12 [square] digits. It is also necessary to find the speed of the flow. The swifter the flow, the more water is supplied by the spring, and the slower it is, the less. One should therefore dig a reservoir to receive the flow, and note with the help of a sun dial how much water flows into that reservoir in a given time, and thus calculate how much will flow in a day. It is therefore unnecessary to measure the area of the cross-section of the stream, for the amount of water will become clear from the measurement of the time.¹⁰ [Italics added.]

Although his technique is primitive, in the foregoing description will be found all of the elements that enter into the most fundamental modern equation pertaining to streamflow namely $Q=AV$ (i.e., the quantity of discharge is equal to the wetted cross-sectional area multiplied by the average velocity of the stream). This equation applies equally well to the movement of avalanches, mud-slides, and any number of similar phenomena. Unfortunately, Hero's concept and methodology were apparently too far ahead of his time. Little attention was paid to them until after the Dark Ages. When those who ultimately adopted Hero's volumetric method and applied it to the design of equipment in modern hydraulic laboratories, they probably did so without realizing that Hero had conceived the idea as much as 1900 years earlier.

EMERGENCE OF MODERN HYDROMETRIC METHODS

$$Q=A \text{ vs } Q=AV$$

As previously mentioned, the prevailing method of measuring streamflow in ancient Rome persisted well into modern times. As noted, it consisted merely of measuring the wetted cross-section of a stream and accepting the area thus obtained for the figure that represented the discharge. The calculation was based simply on the equation, $Q=A$ (quantity equals the cross-sectional area). On Christmas day, 1598, when a great flood occurred on the Tiber River at Rome, one Giovan Fontana was still using that equation and technique when he undertook the task of determining the maximum discharge that occurred during that flood.

Fontana waited for the streams that had contributed to the flood to return to their normal flows. Starting with the Tiber River near Perugia, some 80 miles north of Rome, and also for all of the streams entering the Tiber between that point and Rome, he measured their wetted cross-sections. At the same time, he determined from the highwater marks that remained alongside of those sections the probable areas that the water had occupied when the river and its tributaries had been in flood.

The water in the Tiber, at the Castello di Corbara, nearly a mile above the confluence with the Paglia River, is ordinarily 299 palms wide, and has an average depth of 14½ palms. At the time of the flood, its width was 377½ palms, and it had risen 36 palms. The increase amounted to 135 [square] canna and 90 [square] palms.¹¹

After computing the amounts which each tributary (including the upper end of the main river) had increased on that occasion, Fontana added them all together, and concluded that "the measurements of the Christmas flood show that the area above Rome contributed into the Tiber (at Rome) 500 [square] canna and 9 [square] palms more than the river ordinarily carries."¹²

It will be recognized that the method Fontana had used for gaging these streams was identical to that which Frontinus had used back in A.D. 97 when measuring the streams which contributed water to the Roman aqueducts. To modern hydraulic engineers, who are accustomed to expressing river discharge in terms of cubic feet per second, neither Frontinus' nor Fontana's results would have any quantitative meaning. In fact, they even failed to convey any meaning

to one of Fontana's illustrious contemporaries, Benedetto Castelli (1577?-1644) (Figure 4). In a book entitled *Della Misura Dell'Acque Correnti* [*The Measurement of Running Waters*], first published in 1628 and translated into English in 1661 by Salusbury,¹³ Castelli completely refuted the validity of the $Q=A$ equation.

A large portion of Castelli's book was devoted to explaining the nature of velocity and how it affects the flow in rivers, a phenomenon that both Frontinus and Fontana had not considered. Castelli's work received high acclaim and recognition. Galileo, for example, referred to it as a "golden book," and even today there are many who refer to Castelli as the "Father of Modern Hydrodynamics."¹⁴



FIGURE 4.—Benedetto Castelli.
(Courtesy of Hunter Rouse.)

The date and place of Castelli's birth is somewhat in doubt. Gillispie gives it as 1578, although Poggendorff and several earlier authorities noted it as 1577.¹⁵ Although most authorities claim that he was born in Brescia in northern Italy at the foothills of the Alps, the earliest biographical sketch of him, published in 1661 by Thomas Salusbury, states that he had been born "near Lake Thrasimenus (Trasimeno), where Hannibal overthrew the Roman Legions."¹⁶ Lake Trasimeno is near Perugia, close to the upper end of the reach of the Tiber River where Fontana had measured that devastating flood of 1598.

Be that as it may, Castelli's parents entered him into the Order of Black Friars while he was quite young, and he became one of the monks (and later an abbot) in the Benedictine Order at Monte Casino. The Monte Casino Monastery was located on a high promontory about 87 miles south of Rome. It was destroyed by bombs during World War II, but was subsequently rebuilt at a somewhat lower level. Within this monastery the previously mentioned report on the Roman aqueducts by Frontinus had been copied and preserved. Castelli had doubtless read it there because in his book, he strongly repudiated the $Q = A$ concept of making streamflow measurements as described therein.

While at Monte Casino, Castelli had become an outstanding student of mathematics, a talent that brought him to the attention of the great Galileo. It is known that as early as 1603 Castelli had watched Galileo demonstrate the principle of his "thermiscope" during a lecture at the University of Padua, but apparently it was not until about 1611 that the two had become closely associated. Castelli moved to Florence in April 1611 to be with Galileo, where he became one of the greatest of Galileo's pupils.¹⁷ When Galileo made his famous discovery regarding sun spots, it was Castelli who devised telescopic techniques for plotting their movements, which proved Galileo's observations thereon to be correct. Furthermore, when Galileo ran into trouble with the powerful ecclesiastical forces (as he did on several occasions), Castelli was always the first to advise and defend him. On the other hand, Galileo consistently and lavishly praised the accomplishments of his protégé. At his recommendation, Castelli became professor of mathematics at Pisa, a chair that he occupied from 1613 to 1616.¹⁸

While teaching at Pisa, Castelli became interested in the motion of water in rivers. Pisa is located on the Arno, an extremely unruly river that is subject

to frequent and devastating floods. Attempts to control the river can be traced as far back as the year A.D. 1077. The best engineering talent in Italy had been brought to bear in that effort. About 100 years prior to Castelli's arrival at Pisa, Leonardo da Vinci, the greatest engineer of the Renaissance had worked on that project. Of his work thereon, General William Barclay Parsons has expressed the following views:

In the development of his new design, Leonardo gave the most advanced exhibition of creative engineering imagination that so far had been conceived, and it is doubtful, when his complete lack of precedent and of accurate knowledge are compared with the wealth of both that has been accumulated since, whether his work on the Arno has ever been surpassed as a feat of advance.¹⁹

Under those circumstances, and in the light of what follows, it would seem quite unusual if Castelli had not learned as much as he could about Leonardo and his work on this river. Abraham Wolf states that Castelli was "deeply influenced by the Leonardo school, and [was] probably familiar with the Vatican compilation of Leonardo's notes."²⁰

Early in 1626 he sent to Galileo at Florence for his consideration, two treatises on that subject. During that year also, he was called to Rome by Pope Urban VIII to serve as the papal consultant on hydraulics and as professor of mathematics at the University of Rome.²¹ Within two years thereafter, his famous book *Della Misura Dell'Acque Correnti* (perhaps the final version of the two treatises he had sent to Galileo) was published.

The early chapters of Castelli's book were devoted, as previously mentioned, to a condemnation of the method of measuring streamflow as had been practiced by Frontinus during the early years of the Roman Republic, and later by Fontana in his measurement of the 1598 flood on the Tiber River. Most of the remaining chapters contained his explanation of the nature of velocity and its relation to the discharge of rivers. A few (slightly modernized) extracts of Salusbury's translation of Castelli's work are presented below.²² When reading them it should be kept in mind that in general, these were the first statements to have been published dealing with such subjects. Although some of the terminology is archaic, the basic concepts are still sound.

DEFINITION OF STREAMFLOW MEASUREMENT.—To measure a river or running water is, in our sense, to find out how many determinate measures, or weights of water in a given time passeth through the river or channel of water that is to be measured.²³

FLOATS FOR DETERMINING VELOCITY.—[The velocity of the water may be determined by] keeping account of what space a piece of wood or other body that swimmeth, is carried by the stream in one determinate time, as for instance, 50 pulses . . . ²⁴

PENDULUM FOR TIMING OBSERVATIONS.—Because it will often be requisite to measure time exactly in the following problems, we take that to be an excellent way to measure time, which was shewed me many years since by *Signore Galileo Galilei*, which is as followeth: A string is to be taken three Roman feet long, to the end of which a bullet of lead is to be hanged of about two or three ounces; and holding it by the other end, the plummet is to be moved from its perpendicularity a palm more or less, and then let go, which will make many swings to and again, passing and repassing the perpendicular before it stay in the same. Now it being required to measure the time that is spent in any whatsoever operation, those vibrations are to be numbered that are made while the work lasteth; and they shall be so many second minutes of an hour if the string be three Roman feet long. But in shorter strings, the vibrations are more frequent, and in longer, less frequent; and all this followeth whether the plummet be a little or much removed from its perpendicularity, or whether the weight of the lead be greater or lesser.²⁵

CONTINUITY OF FLOW IN STREAMS.—. . . those streams which carry equal quantities of water in equal times make not the same depths or measures (widths) in the river in which they flow unless when flowing in the river they acquire—or to say better—keep the same velocity. . . .

Because of Castelli's strong disapproval of Fontana's methods, it seems rather peculiar that in 1640, he arranged to have Fontana's report of that 1598 flood republished. The fact that he had done so is shown in Figure 5 which represents the cover page thereof, and the cover page of one of the more recent editions of Castelli's *Della Misura Dell'Acqua Correnti*. The dates at which both of these reports originally appeared—1599 and 1628 respectively—mark the time at which the old $Q=A$ concept was contested, and the time at which the modern $Q=AV$ concept began taking its place.

Free Floats

With a change of focus from other-worldly concerns to those of the nature of the real world, the Renaissance in Europe stimulated the efforts of many remarkable men, most notable among them being Leonardo da Vinci (1452-1519).

Among the more than 8000 note sheets still extant on which Leonardo da Vinci had written and drawn sketches, by far the greatest number of entries on any major subject therein was concerned with hydraulics.

The one group of entries, which is of greatest concern at present, is that which dealt with the velocity distribution of the water in rivers. Philosophers of the Middle Ages had contended mistakenly that the water in rivers flowed much faster near the bottom than at the top. In support of that contention, they would point to the well-known circumstance that if several holes were drilled in a large wooden tank filled with water, the velocity with which the water emerged from the lower hole was always greater than that from any of the other holes. To them, the conditions which prevailed in large water tanks were identical to those in large rivers, and they would condone no experimentation that would either confirm or deny any of their conclusions.

Leonardo, who was intensely curious about all aspects of nature, was also a firm believer in experimentation as the premise upon which to base belief. According to one eminent authority, Dr. Carlo Zambattio, that intense curiosity "set him completely apart from those who preceeded him. His advent brought to the world a new age which aspired above all to UNDERSTAND." His notebooks reveal the manner in which his experiments were made on the velocity-distribution in rivers. The sketch and notes about the rod floats he had made for that purpose appear in Figure 6 along with a recently-built replica of one of them.⁷² Figure 7 contains the author's concept, based on a group of such notes, showing Leonardo behind his odometer keeping abreast the float near the middle of the river. The project involved the following operations:

1. His helper would release a float of just the proper length (short enough so as not to drag against the bottom) several yards upstream from the line stretched across the river.

2. Leonardo would wait at that line with his odometer set at "0." When the float arrived, he would start pushing the odometer down the path, keeping abreast the float, and singing the musical scale up and down say ten times. (According to Marinoni, he had trained himself to sing the scales at a precise rate, and knew the number of seconds it would take him to sing any number of them. He preferred that method to counting his pulse because it was more convenient and under most circumstances, more accurate.)²⁸

3. Upon completing that "song," Leonardo would stop abruptly, note the distance recorded on the odometer and, from the number of times he had repeated those musical scales, the time required for the float

MESVRE RACCOLTE
**DA GIOVAN
 FONTANA**
 ARCHITETTO,

Dell'Accrescimento che hanno fatto li Fiumi, Torrenti, e Fossi che hanno causato l'inondatione à Roma il Natale. 1598.

Ristampata ad istanza del Sig.
 Domenico Castelli.



IN ROMA

Appresso Antonio Mariae, Gioioli.
 M. DC. XXXX.

**DELLA MISVRA
 DELL'ACQUE
 CORRENTI.**

DI D. BENEDETTO CASTELLI

Abbate di S. Benedetto Aloysio, e Matematico

DI PAPA VRBANO VIII.

Professore nello Studio di Roma.

In questa terza edizione accresciuta del Secondo libro, e di molte curiose Scritture non più stampate.

ALL' ILL.^{MO} E REV.^{MO} SIGNOR

**ABBATE VRBANO
 SACCHETTI.**



In BOLOGNA, per gli HH. del Dozza. M. DC. LX.

Con licenza de' Superiori.

FIGURE 5.—Title pages of Fontana's and Castelli's books. These books symbolize the passage of the old $Q = A$ concept and the advent of the modern $Q = AV$ concept for measuring water flow in conduits and in open channels.

to have traveled that far. From this he would compute the float's velocity. While all this was taking place, he would have observed whether the float tilted forward or backward, thereby noting whether the velocity near the top of the stream was greater or less than near the bottom.

4. He would finally retrieve the float and return again to the point of beginning. His assistant would thereupon release another float at a greater distance from his side of the river. The whole procedure would then be repeated until the entire width of the stream had been covered and the velocity distribution throughout its entire cross-section had been determined.

The conclusion Leonardo arrived at after having completed his experiments is noted in several places

in his notebooks, but perhaps most completely in Codice Atlantico, folio 124 r. a, which has been translated as follows by MacCurdy:

Of water of uniform weight, depth, breadth and declivity, that portion is swifter which is nearest the surface; and this occurs because the water that is uppermost is contiguous to the air, which offers but little resistance through its being lighter than the water; and the water that is below is contiguous to the earth, which offers great resistance through being immovable and heavier than water. It follows that the part which is more distant from this base has less resistance than that above which is contiguous to the air, for this is light and mobile.²⁹

Leonardo's rod float is the earliest device to have been found so far that was specifically designed for the purpose of measuring stream velocities. The additional feature it provided, namely that of indicating

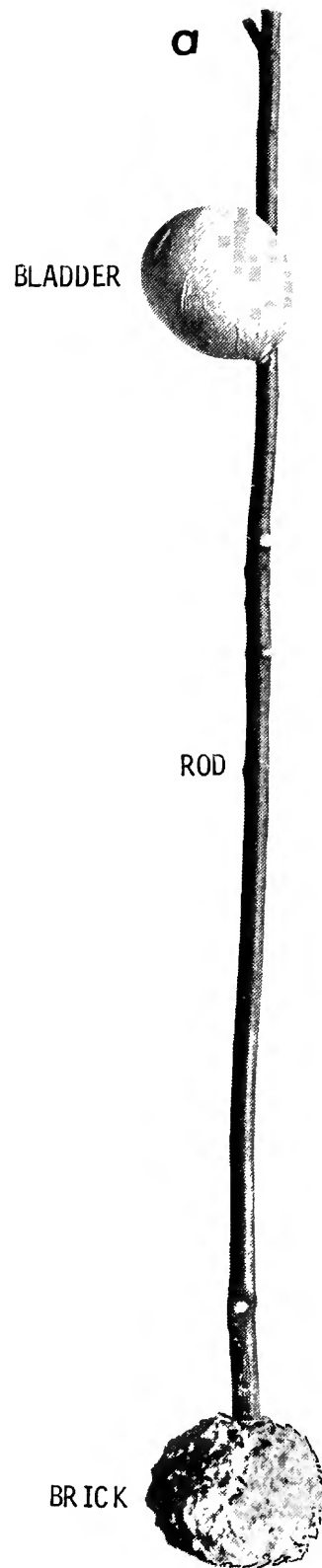
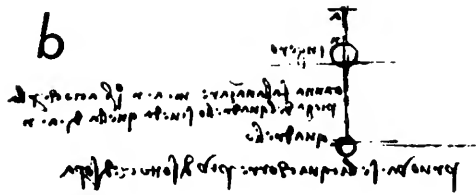

"Let the rod project one braccio at A N so that the displacement of the brick can be distinguished at A N."

"This demonstrates whether the water is flowing faster below or at the surface."

FIGURE 6.—Leonardo da Vinci's rod float for investigating the subsurface water velocities in streams, as reconstructed by the author (a), from Leonardo's notes. (b). (From da Vinci, Manuscript "A," folio 42 v.)



FIGURE 7.—Leonardo conducting experiments on the velocity-distribution in streams.
(Drawn by A. H. Frazier.)

whether the surface or bottom velocities were greater, reflects some of the special genius with which Leonardo was endowed.

It may be interesting to note here that when Leonardo conducted these experiments, he obtained enough data (a detailed cross-section of the stream and velocity observations at numerous locations therein) to compute the stream's actual discharge. No evidence has been found, however, that he had pursued any such objective, although on more than one occasion he had studied the rate of flow through orifices. Apparently his only plan on this occasion was to make a velocity-distribution study. Aside from wanting to satisfy himself as to what the true circumstances were, he might also have wanted to demonstrate that the theories of contemporary philosophers (for whom he had very little admiration) were wrong.

Although Leonardo's paintings and writings about art had received wide acclaim both during and after his lifetime, his 8000 or more pages of scientific notes

failed to attract any immediate or widespread attention. At several places in those notes, he had expressed an intention to reorganize for publication those particularly relating to hydraulics. He had prepared several lists of chapter headings, and in several other instances he had drafted one or more paragraphs which were obviously intended for use in such a publication. He never made, however, any further progress thereon before his death. Moreover, the persons who subsequently got possession of those notes only seemed interested in those which related to painting.

Finally, an eminent hydraulic experimenter named Giovanni Battista Venturi (see pages 37-40) published, in 1797, a booklet entitled *Essai sur les ouvrages physico-mathematiques de Leonard de Vinci*, which, at long last, focused attention on Leonardo's remarkable scientific achievements. Suddenly the dozen or so persons and libraries that had acquired any pages from Leonardo's notebooks found themselves in possession of unexpected and priceless treasures.

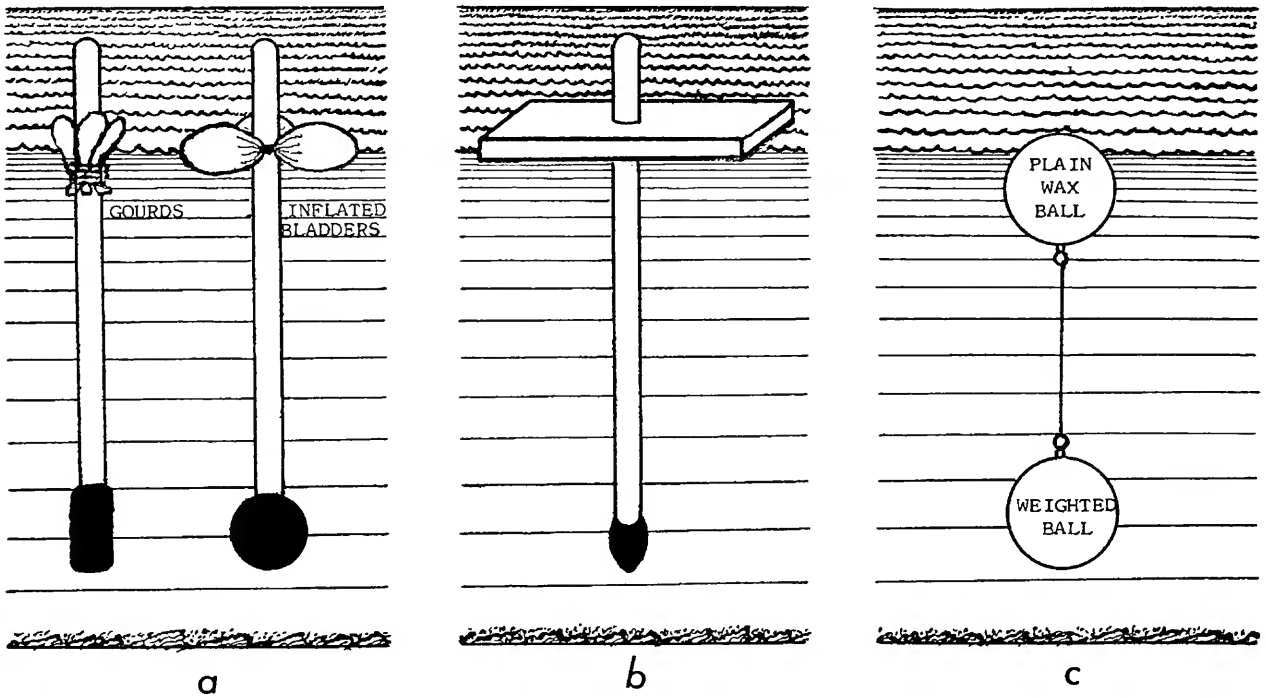

FIGURE 8.—Earliest floats post-dating Castelli's book on water velocities: *a*, Cabeo's rods, ca. 1646; *b*, Barattieri's rod float, ca. 1663; *c*, Mariotte's double float, ca. 1680. (Drawn by A. H. Frazier, from Masetti, "Descrizione.")

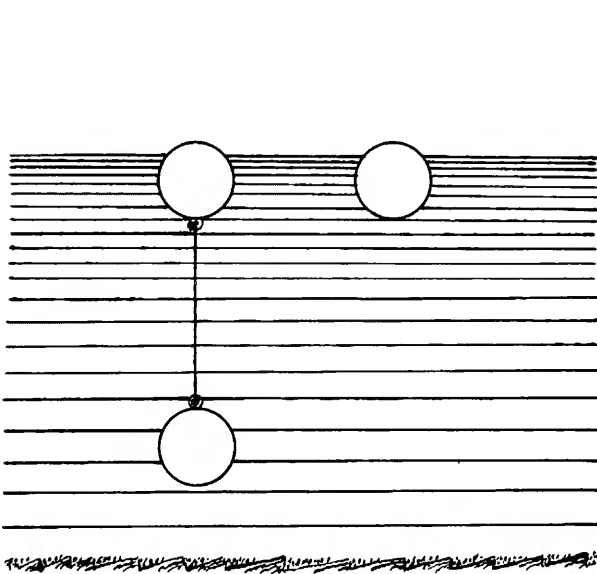

FIGURE 9.—Brunacci's combination single and double float, ca. 1805. (Drawn by A. H. Frazier, after Masetti, "Descrizione.")

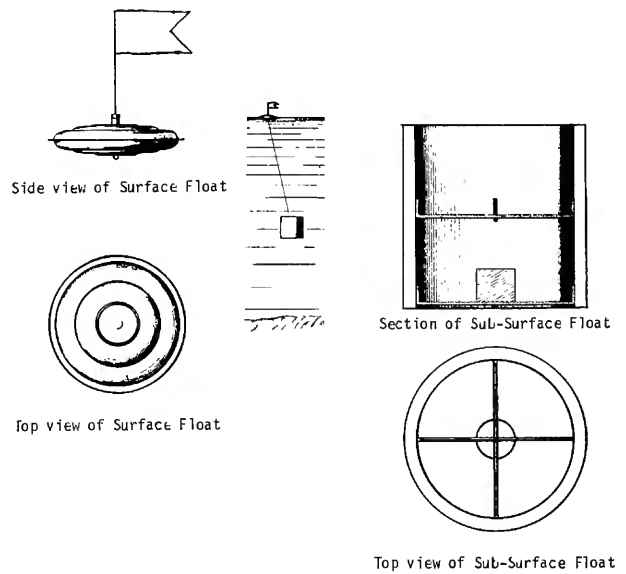

FIGURE 10.—A double float, such as was designed and used by General Ellis on the Connecticut River, ca. 1875.



There can be little doubt that men had long been aware of the existence of velocities in rivers by merely having observed materials floating on them. Accordingly, floats became the first and most natural facility for studying velocities. It has already been shown that Leonardo used floats for that purpose, although his unpublished observations thereon failed to either come to the attention of, or to motivate, any immediate followers. In fact, more than 100 years elapsed before Benedetto Castelli's work aroused any general interest in the subject. Many scholars, including Abraham Wolf, have noted many similarities between Castelli's comments about water velocities and those of Leonardo da Vinci's, and have expressed their beliefs that Castelli had made use of many of Leonardo's observations thereon when writing his book. Nevertheless, Leonardo had attracted relatively few (if any) immediate followers in this field, whereas Castelli had attracted a large number of them. It was Castelli's proposal to use floats for measuring velocities, not Leonardo's, that started the vogue in that respect, a vogue which has never completely disappeared.

Among Castelli's numerous followers were several who preferred to use rod floats which, like Leonardo's, would travel in an upright position; others preferred wooden spheres, or balls of wax. It would be almost an endless task to describe them all, but a fair idea of how some of them appeared can be obtained from Figure 8 which shows three models used before the end of the 17th century by Nicola Cabeo (1585-1650), G. B. Barattieri (1601-1677), and Edme Mariotte (1620-1684), respectively. An additional feature (Figure 9) introduced by Vincenzo Brunacci (1768-1818) in about 1805, consisted of merely providing a separate and completely loose ball along with Mariotte's double float. This additional ball was allowed to travel with the double float during each of its "runs." Its speed was generally greater than that of the double float because it was not held back by the more sluggish lower ball. Here, according to Masetti, is what Brunacci achieved with such equipment:

Having determined with an ordinary float the speed at the surface, and having simultaneously measured the velocity at which the two-ball assembly travelled, he could quickly find

FIGURE 11.—One of James Francis' rod floats. From the large set of rod floats used by James Francis while Chief Engineer of the Proprietors of Locks and Canals, Lowell, Massachusetts, ca. 1855. It is held by one of his successors, George Whitaker (1907-1962).

the speed of the current at the depth to which the heavier ball had been lowered by using a very simple formula based on the theory of such a meter.³⁰

It should not be assumed from the foregoing remarks that free floats became increasingly scarce during the later centuries. Like practically all early velocity-measuring devices, they continued to make sporadic appearances even up to the present. With the publication of Humphreys' and Abbot's famous report on the Mississippi River, for example, double floats similar to that designed by Mariotte received official endorsement:

Various methods were resorted to. Saxton's current meter was tried, but proved to be unsuited to measurements

in a river of such great depth and violence of current. *Only double floats were found to give reliable results.* [Italics added.]³¹

Perhaps the most carefully designed *double floats* (Figure 10) ever to have received actual field use were those that General Theodore G. Ellis (1829-1883) made for his studies on the Connecticut River between 1867 and 1877 under General Humphreys. Perhaps the best *rod floats* (Figure 11) ever to have been designed, were those of the set used by the distinguished hydraulic engineer, James Francis (1815-1892) of Lowell, Massachusetts, who (among other purposes) used them to develop the famous Francis Weir formulas.

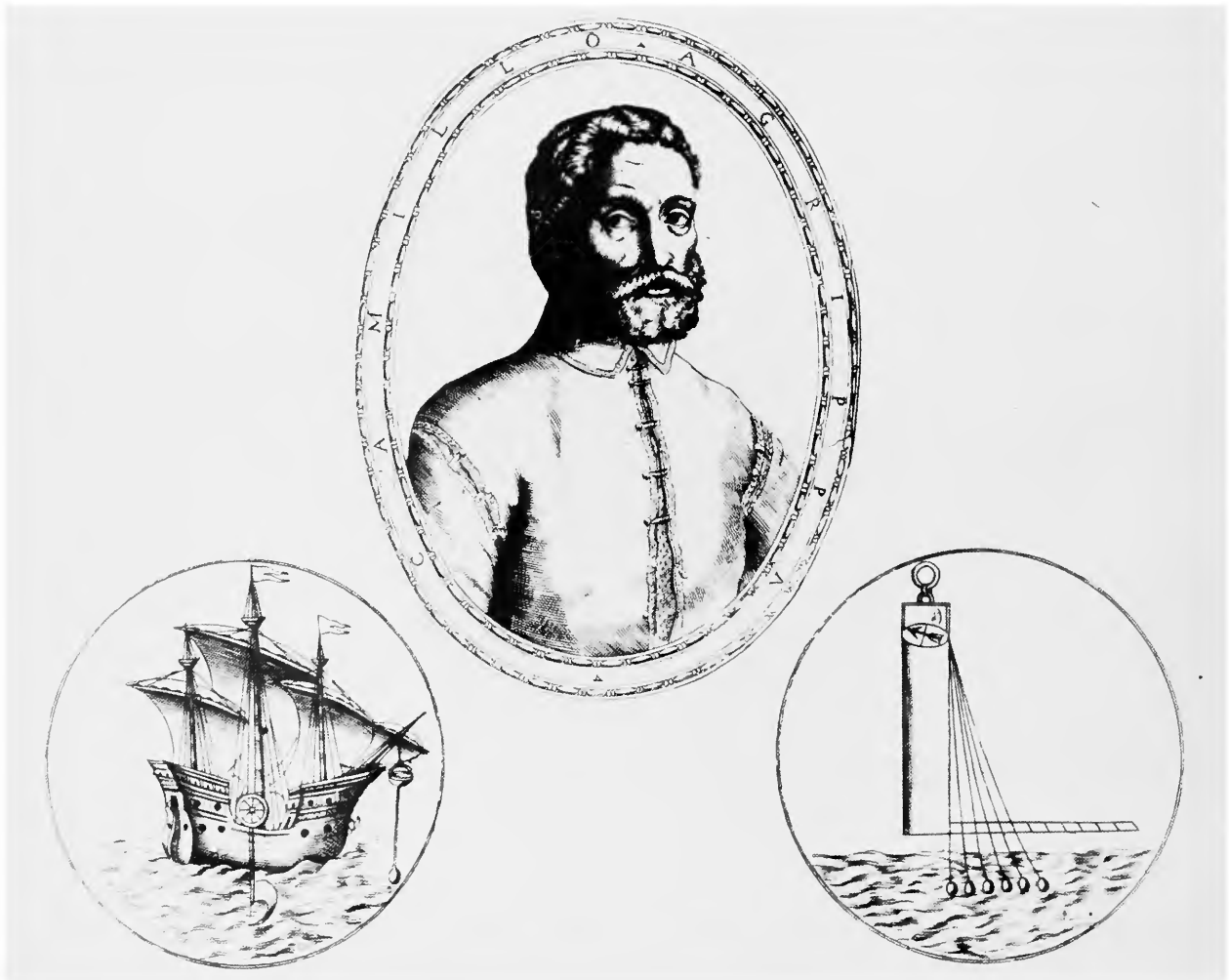

FIGURE 12.—Camillo Agrippa, his ship, and ship's log, ca. 1595.
(From *Agrippa, Nuove Inventioni.*)

Tethered Floats

The advent of “free” floats was followed by one that will be called here “tethered” floats, because the major feature thereof consisted of a ball, generally heavier than water, to which a cord was attached to limit the distance that it could travel downstream. The use of such devices had been anticipated in the navigation field by an early ship’s log, a description of which appeared in a booklet entitled *Nuove Inventioni di Camillo Agrippa*, published in 1595.³² A portrait of Agrippa, his ship, and a close-up view of his invention appear in Figure 12. As may be seen in the close-up view, the device consisted of a large frame shaped like a carpenter’s square which would be suspended either from the ship’s foremast, or from a boom extending outward from the ship’s rail. Its downstream leg, which was graduated throughout its length, would be brought to rest horizontally, just above the water’s surface. The ball, heavier than water, was suspended from a cord fastened to the

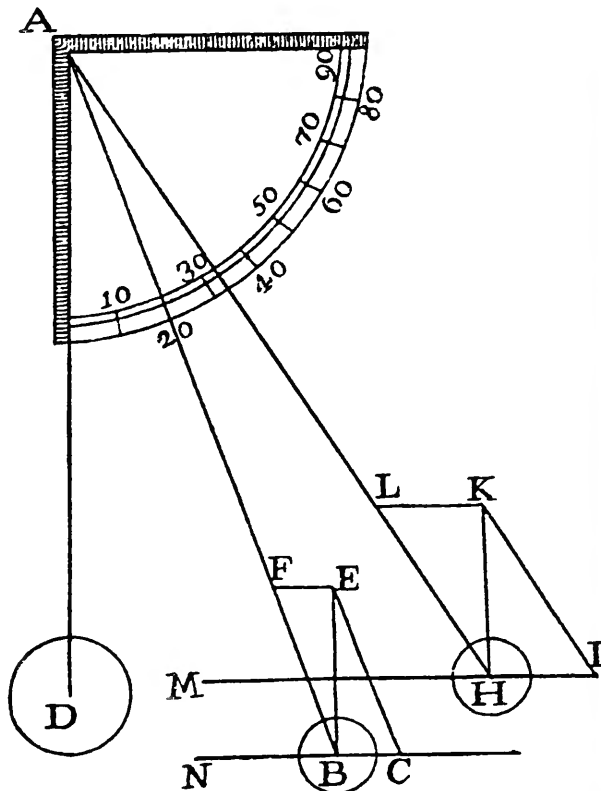

FIGURE 13.—Guglielmini’s “quadrant and ball,” ca. 1690. The force diagrams indicate the proportions one velocity bears to another. (From Guglielmini, *Opera Omnia*.)

upper edge of the frame, the cord being sufficiently long to permit the ball to be submerged a foot or two below the surface of the water. As the ship moved forward, the ball would lag behind the other parts of the frame by an amount that depended upon the speed of the ship. The extent of that lag could be observed from the position of the cord as it crossed in front of the scale on the horizontal leg. By positioning those graduations appropriately, the actual speed of the ship could be read thereon.

Whether Domenico Guglielmini (1655-1710) had ever heard of Agrippa’s ship’s log is not known, but in his book, *Aquarium Fluentium Nova Methodo Inquisitia*, published in 1690 and 1691, he described a velocity-measuring facility called a “quadrant and ball,” which operated on exactly the same principle. Figure 13 shows two positions of the ball (as would be caused by two different velocities), and force diagrams that he used for determining the proportions the two velocities bore to each other.

Guglielmini (Figure 14) became the most highly



FIGURE 14.—Domenico Guglielmini. (Courtesy of Hunter Rouse.)

respected hydraulic engineer in Italy during his time. He was born in Bologna 27 September 1655 and received an exceptionally good education. A degree of Doctor of Physics was conferred on him by the University of Bologna in 1678. His greatest interests first centered around astronomy, but they soon shifted to hydraulics. The Senate of Bologna then appointed him to the positions of First Professor of Mathematics and General Superintendent of Waters. While holding those positions, he wrote several treatises about flowing water, the first of which has been cited above. In 1694 the City of Bologna founded a new chair of Professor of Hydrometry in its university and gave it to him. The word "hydrometry" made its first appearance in that title. After having published a book on *The Nature of Rivers* in 1697, he was chosen a member of the Italian Royal Academy of Sciences. One of his early biographers reported, "This book—an Original of its kind, made a great Noise . . . The Common-wealth of *Venice*, envying the Happiness of *Bologna*, called him in the Year 1698 to the Professorship of the Mathematicks at *Padoua*." ³³ In 1702 he became that university's Professor of Theoretical Physics. Soon thereafter, chemistry became his favorite subject, so before long he wrote a few books on chemistry. The last thereof was published during the

final year of his life, 1710.

Because of the great advances in hydraulics since the 17th Century, most modern hydrographers are not likely to display as much enthusiasm for Guglielmini's work as did his contemporaries. While most of it was quite sound, his quadrant and ball produced very misleading results particularly when used on deep swift rivers. Its fault rested in the fact that it failed to eliminate the effect of the pressure which the flowing water exerted against the cord from which the lower ball was suspended. As that ball came closer to the bottom of the stream (where lower velocities normally occur, and where the angle as read on the quadrant should become smaller), the drag of the water against the greater length of cord which was paid out would more than offset the decrease of pressure against the ball, and the angle read on the quadrant would become larger. Obviously unaware of that inherent fault in his instrument, Guglielmini stated unequivocally at several places in his earlier works that the velocity at the bottom was greater than near the top. He is said to have changed that belief in later years, but so far, no evidence has been found to indicate that he attributed any of that error to his instrument. Just how much that effect could distort the true results will become evident by comparing the

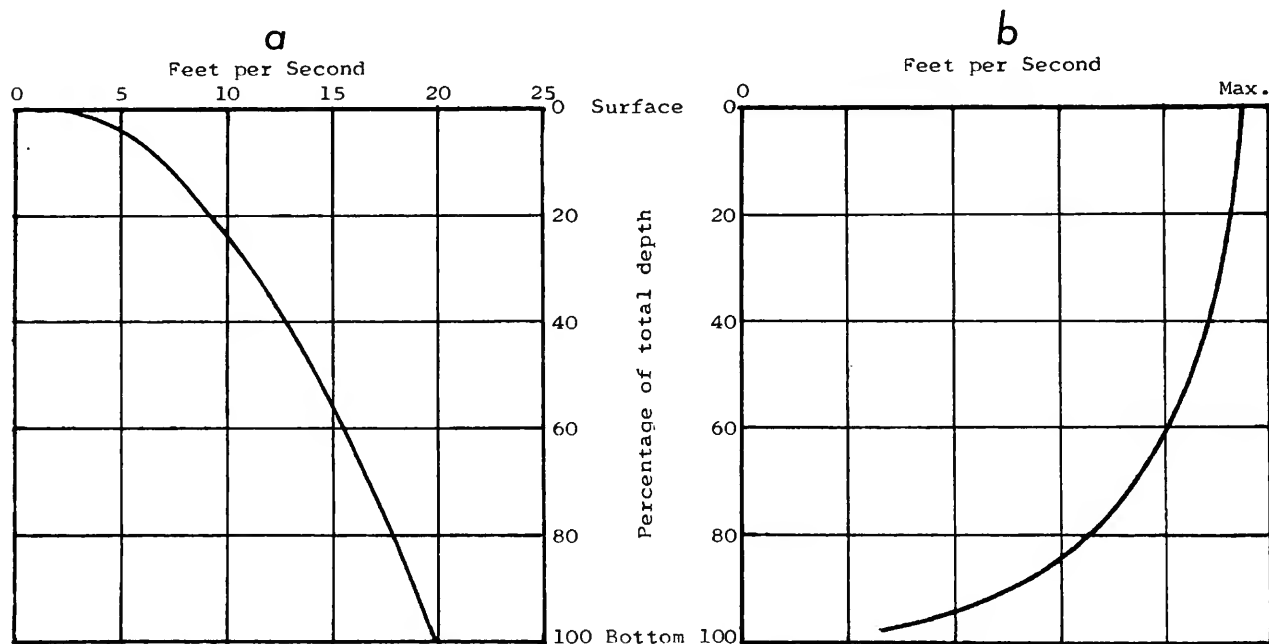

FIGURE 15.—Comparison of Guglielmini's erroneous vertical velocity curve with its modern counterpart: *a*, Guglielmini's curve developed with his quadrant and ball; *b*, modern curve developed with modern equipment.

vertical velocity curves shown in Figure 15. At the right thereof is what modern hydrographers have found to be the correct general shape of such curves, whereas to the left of it is the same type of curve based on data which Guglielmini himself observed with his quadrant and ball on a 35-foot-deep river.³⁴ It will be seen that one is practically the reverse of the other insofar as the vertical velocity distribution is concerned.

Despite its faults, Guglielmini's quadrant and ball attracted many followers. Figures 16a-d show two of the various types which were obviously inspired by his model. Figures 16a, b resemble his original model closely; those in 16c, d reflect a preference for a weighted rod rather than for a weighted ball; Figures 16e, f differ from the others in that the quadrant has been replaced by spring scales; and those in 16g, h illustrate an innovation which, although much more cumbersome for use in deep swift water, would tend to eliminate much of the fault found with Guglielmini's original model.

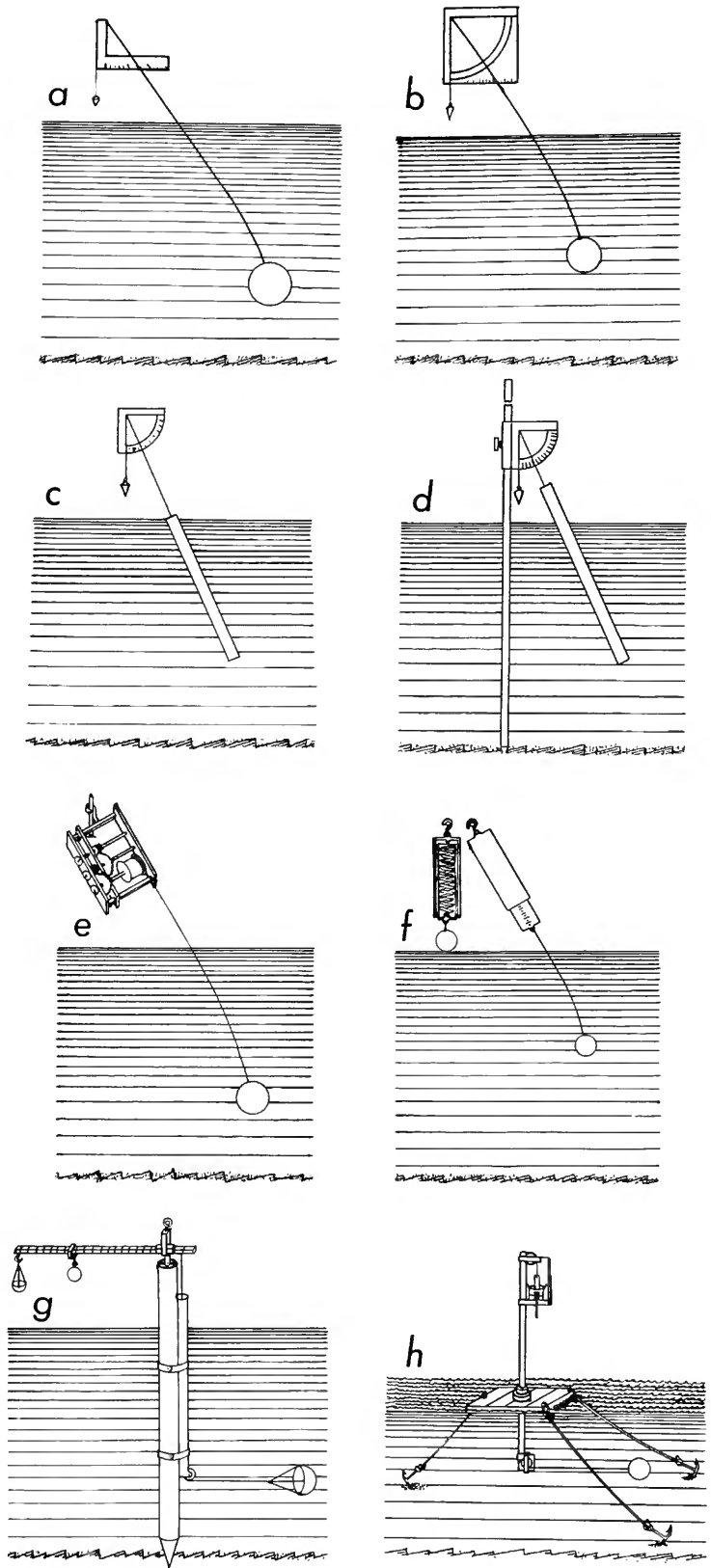

FIGURE 16.—Successors to Guglielmini's quadrant and ball: a, Cava's square, ca. 1721; b, Ximenes' quadrant, ca. 1752; c, Ferrari's sectional rod, ca. 1796; d, Venturoli's compound pendulum, ca. 1796; e Ximenes' clock-spring device, ca. 1752; f, Ximenes' spring-scale device, ca. 1752; g, Lorgna's device, ca. 1777; h, Barbantini's hydraulic counterweight, ca. 1814. (Redrawn by A. H Frazier after Masetti, "Descrizione.")

PADDLES

Man's early use of crude paddles to help propel a log or raft across a stream obviously extends back into prehistoric times, and the principles learned on those occasions ultimately became applied to a considerable group of current meters. The forces that are in effect when paddles are placed in water do not always produce the same results. If a person sitting in a canoe applies a backward force to the paddle, for example, the canoe will move forward, whereas if the person were sitting on the bank of the stream and held the paddle in the current, the paddle would tend to be pushed backward. It is this latter effect that was ultimately adopted in the design of current meters for measuring the velocity of running water.

The amount of force required to hold the paddle squarely against the current would depend upon the

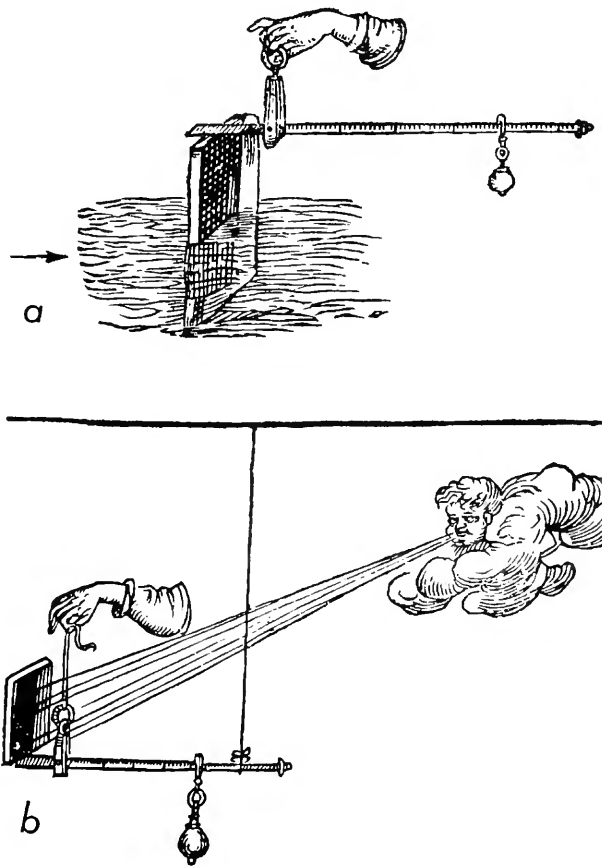

FIGURE 17.—Santorio's inventions: *a*, water current meter; *b*, anemometer. (From Santorio, *Commentaria*.)

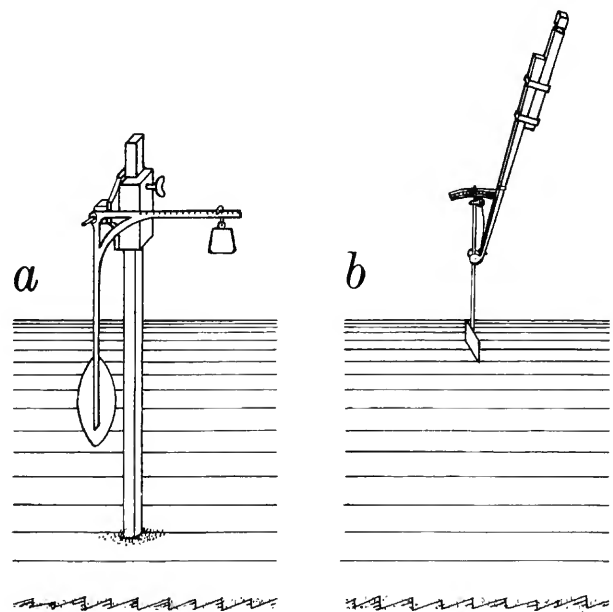

FIGURE 18.—Gauthey's current meters, ca. 1779. (*a*, from Van Winkel, "Streamflow"; *b*, drawn and reconstructed by A. H. Frazier after Masetti, "Descrizione.")

dimensions of the paddle and the velocity of the current. By using the same paddle throughout a series of experiments, and by using some method of measuring the force required to prevent the paddle from swinging downstream, the *relative* speed of the current at many different locations could be determined. The *actual* speeds of the water could also be determined thereby, but the mathematics involved would be considerably more complicated.

The earliest record of a paddle-type current meter was that reported by Dr. Santorio Santorio (1561-1636). Encyclopedias report that he was the world's first iatrophysicist (one who explains diseases of the body in terms of physics rather than of chemistry), and the inventor of many useful medical instruments. The particular instrument that brought Santorio the most acclaim was his invention of the *clinical* thermometer. It was similar to Galileo's thermometer (which was designed to measure atmospheric temperatures), but Santorio modified it in such a way to measure body temperatures of his patients who were afflicted with a fever. In 1610, he turned his attention

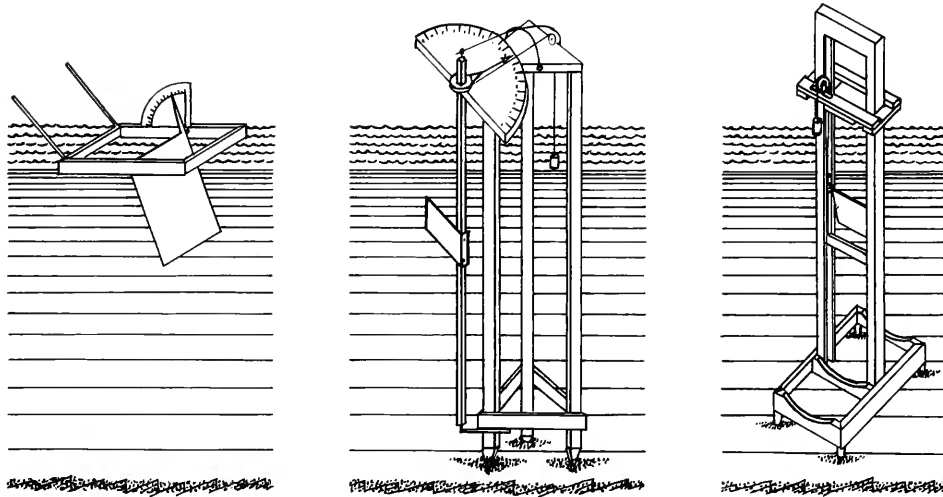

FIGURE 19.—Ximenes' paddle type current meters, ca. 1780.
(Drawn by A. H. Frazier after Masetti, "Descrizione.")

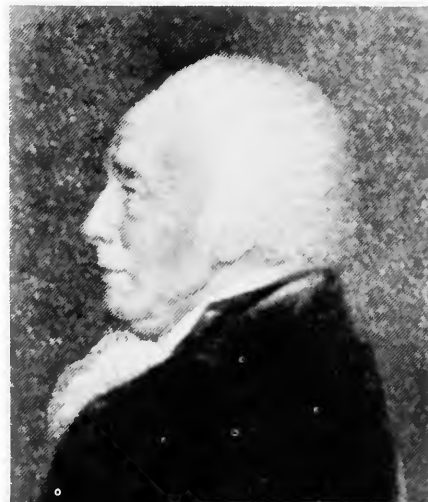
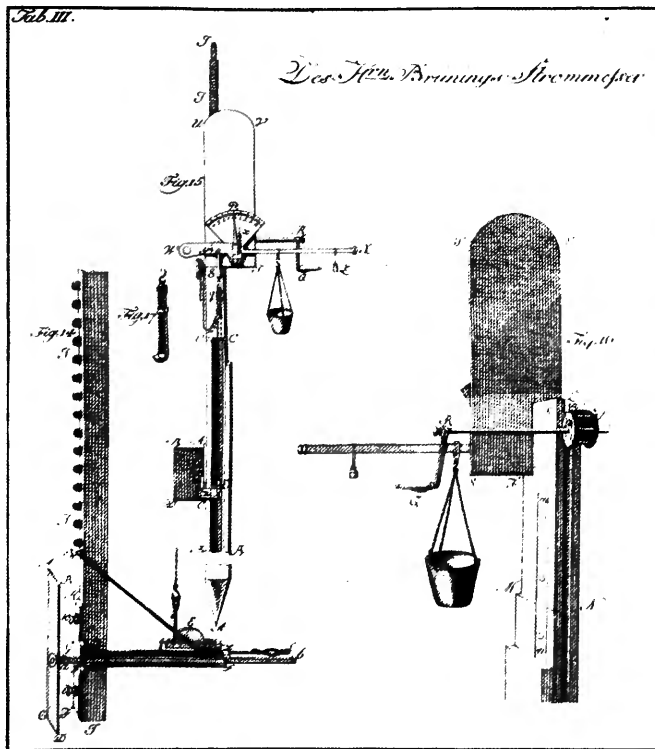

FIGURE 20.—Christian Bruning and his current meter, ca. 1788.

to the construction of an anemometer and a water current meter (Figure 17). As Carlo Zammattio has pointed out, Santorio had made his drawings known to the public before 1611, almost 18 years before the first edition of Castelli's famous work on water velocity was published. The circumstances under which they were invented, as translated by Zammattio from Santorio's book *Commentaria In Primam Fen Primi Libri Canonis Auicennae*, are presented below:

Some people are benefited, and others harmed during rainy weather. Similarly, the heavy impact of falling or running waters tends to produce sleep in some, and to prevent sleep in others. But I would like to mention here a condition I had observed in Croatia, where there is a place renowned for the noise of winds, and for the great tumult of rushing waters. At some times people of the community are aroused from sleep by this uproar, and at others they are lulled to sleep by that same noise. I therefore proposed, as a means of subtly ascertaining the reason for those circumstances, that one should weigh, with a balance scale, the amount of impact produced under both circumstances. When urged by friends to show how that could be done, I prepared two staters (Roman balances) on both of which a plate is mounted at right angles. By means of the first (with the plate pointing upwards), the impact of the winds could be weighed; by means of the second (with the plate pointing downwards), the impact of the water. The one having the plate pointing upward for measuring the impetus of the wind helped us to predict when such winds tended to increase. We could thus forecast weather at sea, and could avoid the peril of sinking ships. It further provided the means whereby we could be more sure as to whether the impact of the winds tended to increase or decrease. Other uses for this device are described in the book regarding medical instruments.

The other instrument (on which the plate hangs downwards) allows us to weigh the amount of impact produced by running waters. It might have primary usefulness for improving the efficiency of mills and for other applications. In consequence of its use, we shall be able to ascertain what amount of impact has beneficial properties, and what amounts would have harmful properties for our patients. Actually, if certain amounts of impetus or noise are salubrious, and others are unsalubrious, by what better means could we measure the effectiveness of our medicines?²⁵

Zammattio has suggested that the location in Croatia (now part of Yugoslavia) to which Dr. Santorio had referred, may have been at the great Caverns of St. Canziano del Carso, some 60 miles east of Trieste, Italy. There a river disappears with a tumultuous roar into a vast underground cavern. There also, occurs the "bors"—a terrific wind that blows down from the European plains throughout the year.

Although Santorio's device measured only the impact of the water striking the plate (making no attempt to convert the results into actual velocity

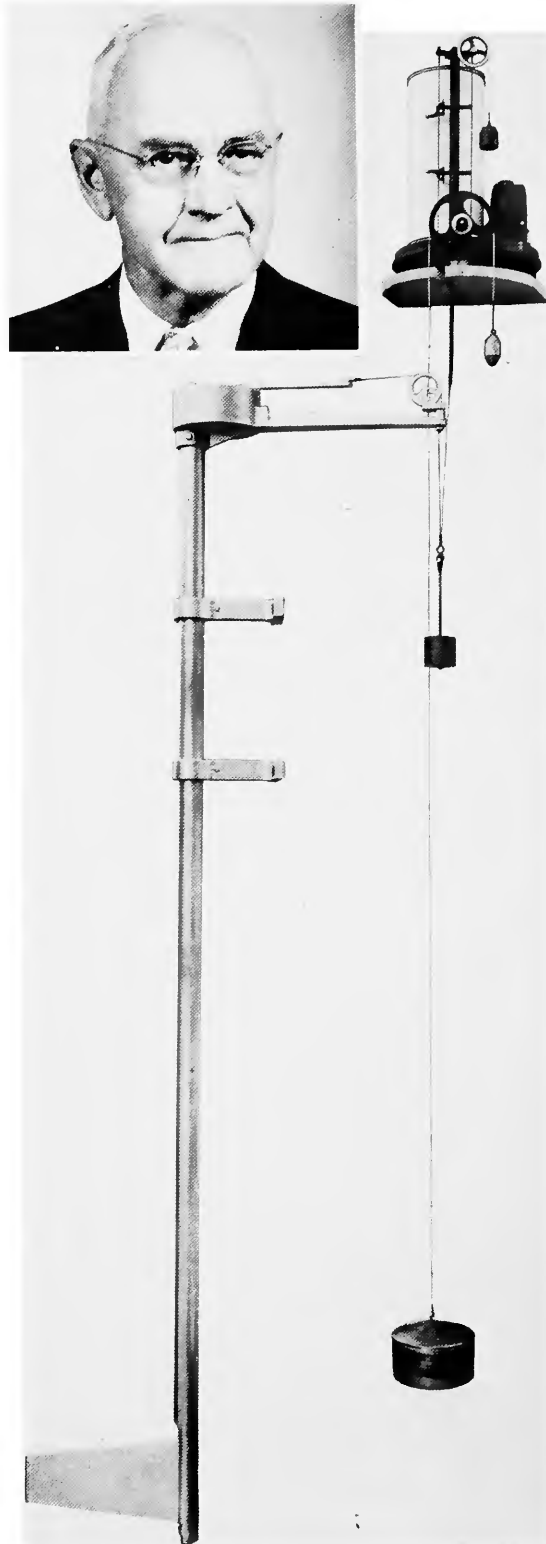

FIGURE 21—Karl F. Keeler (b. 1888) and his deflection meter.

values), it should be realized that the mathematical tools for making such conversions had not yet been conceived.

Beginning in 1779 (more than one and one-half centuries after the advent of Dr. Santorio's devices), a whole rash of paddle-type current meters appeared. As a matter of fact, they have continued to do so up to the present. The earliest on record of this new crop are the two made during 1779 by the great French canal builder, Emiland Marie Gauthey (1732-1806). Gauthey was a graduate and later an Inspector Générale of the École des Ponts et Chaussées of Paris, the foremost engineering college in the world at that time. Gauthey's model (Figure 18*a*) bears such a close resemblance to the one designed by Santorio, that it is tempting to assume that he might have heard about the doctor's model. It may be noted that while the principle of operation is the same in both models, that shown in Figure 18*a* measures the water's impact against the plate (while it is kept normal to the current) by means of a balance, whereas the other (Figure 18*b*) measures it by means of a spring scale.

During the next year Leonardo Ximenes (1716-1786) introduced the three models shown in Figure 19. Figure 19*a* was intended for measuring surface velocities only, but Figures 19*b* and *c* could be used to any depth not exceeding the overall height of the framework.

In all three of Ximenes' models, the panels (or blades) were allowed to swing downstream—the degree depending upon the speed of the current—in contrast to the earlier equipment in which the blade had to be held normal to the current at the time readings were taken. In the first model (Figure 19*a*) the pressure against the plate is resisted entirely by the weight of the panel itself. In Figure 19*b* a single weight provides the force which resists the pressure against the blade (which in this case is suspended to swing laterally rather than vertically). In Figure 19*c* the weight of the blade, plus that of an additional weight, combine to oppose such pressures.

Since the manufacture of "paddle-type" current

meters continues to the present, and therefore, are too numerous to cover here, only two additional models will receive attention. That shown in Figure 20 was designed by Christiaan Bruning (1736-1805), a Dutch hydraulic engineer, who had been educated at Heidelberg University and who ultimately, in 1803, became the Director General of Holland's river and sea operations. It may be noted that in his device, the impact of the water tended to push the flat plate straight backwards, but was restrained from doing so through a counter pressure applied at the balance scale at the upper end of the support rod. Readings obtained from the amount of weight required to establish an equilibrium could be converted into figures representing the velocity of the water. Bruning's paper³⁶ about this equipment was published in Holland in the late 1780s, for which the Dutch Academy of Sciences awarded him a gold medal.

Reinhard Woltman, whose current meter will be discussed later in this study, was a great admirer of Bruning, and in 1790, when Woltman published an account of his own current meter,³⁷ he included therein the drawings of the Bruning meter shown in Figure 20.

The deflection meter shown in Figure 21 was designed by Karl Fairbanks Keeler, an American hydraulic engineer. This meter, constructed in 1937 by Leupold, Volpel & Co. of Portland (now Leupold and Stevens, Incorporated of Beaverton, Oregon), is perhaps the most sophisticated paddle-type device ever built in that it has been interconnected with a water-stage recorder, which registers simultaneously both the height of the stream and the angle assumed by the blade. Its purpose is to help obtain records of the flow in canals that are subject to backwater variations.

A number of these models have been manufactured by the Leupold and Stevens firm. Most of them have been installed at gaging stations operated by the International Boundary and Water Commission, United States and Mexico, in which Keeler had been employed for many years as the Supervising Hydraulic Engineer.

PADDLE WHEELS

Paddle wheels similar to those that propelled the early Mississippi River steamboats—but much smaller, of course—have been used fairly extensively both for

registering the speed of a ship at sea and the surface velocities of the water flowing in rivers. Here again, the application in the navigation field was the earlier

of the two. The first published record of a paddle wheel for use as a ship's log was contained in the first volume of Vitruvius' book on Architecture, written in about the first century B.C.³⁸ A drawing, based on Vitruvius' description of that device is shown in Figure 22. As may be seen, a pair of paddle wheels, one on each side of the ship, but mounted on the same shaft, drove a train of reduction gears. The final gear in the train just cleared a special upper deck in the hold of the ship. It had a series of holes through it which formed a circle just within its outer circumference. At regular intervals of time a single round stone would be placed in each of those holes, and these stones would be pushed along by the gear during the course of its circular travel. The reduction accomplished by these gears was so great that the ship had to travel a distance of one mile to cause each successive hole to reach a point where an opening had been cut through that special deck to allow each stone in its turn to drop through into a large bronze container

on the lower deck. Each mile of travel would therefore be announced by a loud "clang" as the stone would strike against the rim of that container. By counting the number of stones that had accumulated therein, the Captain could determine the number of miles which the ship had traveled.

This device also could be used to measure velocities in rivers by merely anchoring the ship in the current and allowing the log to perform its function in the same manner as it does when the ship is moving in still water.

European Contributions

The earliest paddle wheel to have been found so far which was built specifically for measuring the velocity of water flowing in open channels, is that made by Luigi Ferdinando Marsili (1658-1730), sometimes spelled Marsigli (Figure 23). He used it in about 1681 for studying the velocities in the Bosphorus between

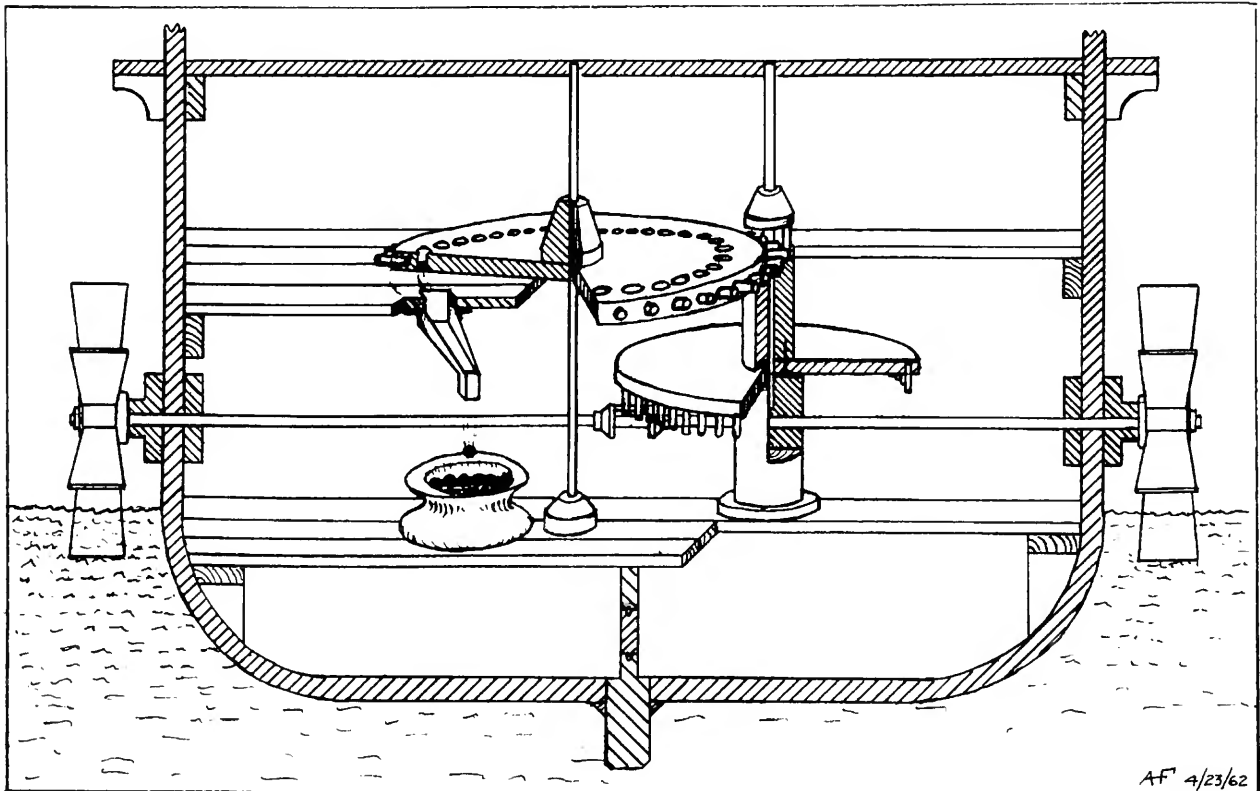
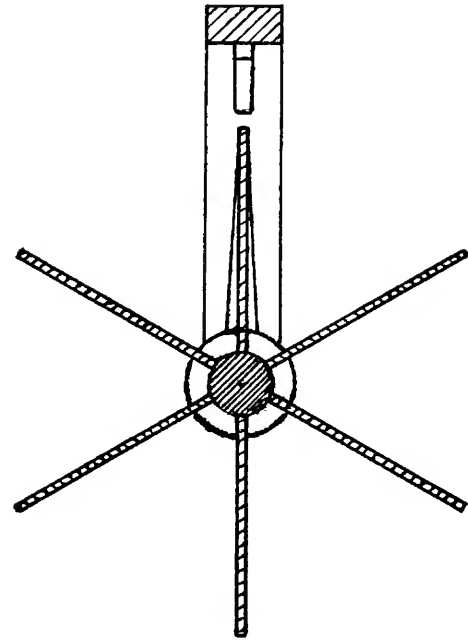

FIGURE 22.—World's first mechanical ship's log as described by Vitruvius in first century B.C.
(Drawn by A. H. Frazier.)



Cross-Section A-A

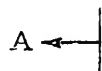
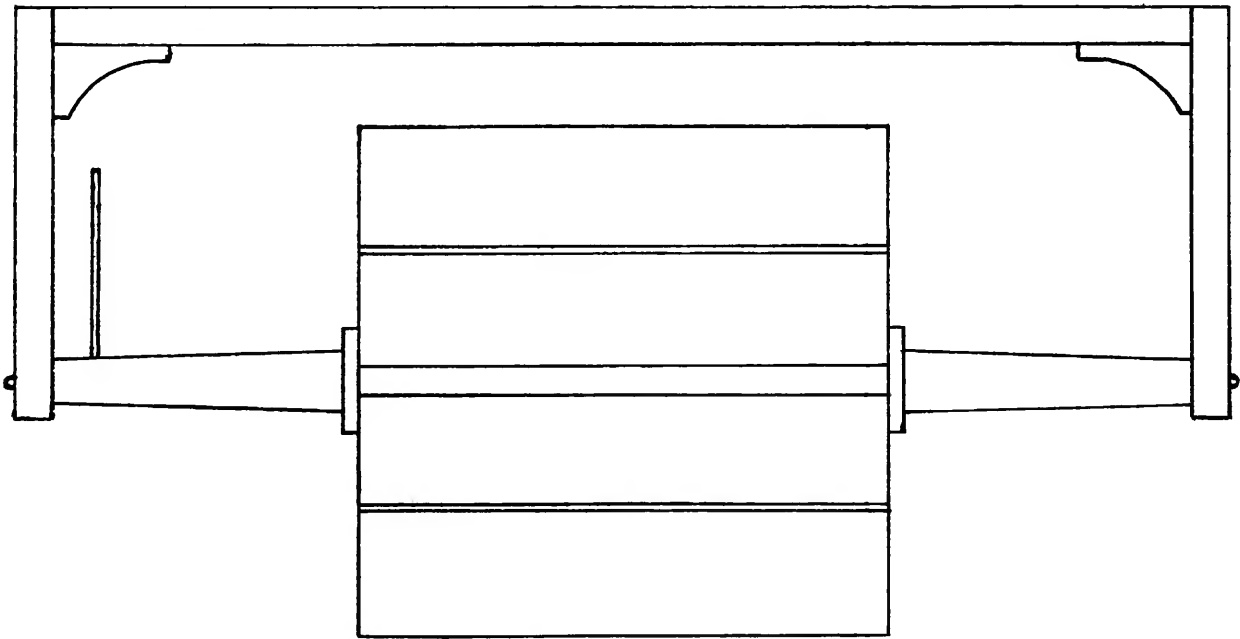
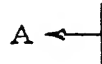

FIGURE 23.—Marsili [Marsigli] and drawings of his current meter. (Portrait from *Enciclopedia Italiana di Scienze*; drawings from *Milanese*, "Santorio.")

the Black Sea and the Sea of Marmora, and later on rivers in the Danube Valley. A translation of his description of that meter, containing a few minor modifications from that which was recently prepared by Fernando Milanese, an engineer of Milan, Italy, follows:

To measure the velocity of the current at the Leandro Tower, I built a wooden apparatus which had a wheel provided with six blades, each about a foot broad. I fastened the wheel to a tapered shaft about 5 feet long, and installed a pointer at one end to assist in counting the number of revolutions performed by the wheel as the water struck directly against the lowermost blades. . . . While holding the axle of the wheel in a horizontal position with just the lower blades submerged in the water, a six-inch-long pendulum made 100 oscillations while the wheel, as observed from the pointer, made 38 revolutions. By performing similar experiments, the velocities of any river can be compared to the one that I had measured.³⁹

Many writers, obviously unaware of Marsili's earlier work, have credited Francesco Domenico Michelotti (1710-1777), Professor of Mechanics at the University of Torino (Turin) with having been the inventor of the paddle-wheel-type current meter (Figure 24*b*). His two-volume work on hydraulics entitled *Sperimenti Idraulici*⁴⁰ contains among its illustrations, the two shown in Figure 24. Probably the leading hydraulic engineer in Italy, Michelotti had the opportunity to use most of the velocity-measuring devices which were in vogue during his time. Figure 24*a* appeared at the beginning of one of his chapters. It shows most of the equipment that a professional hydrographer of the 1760s might have taken on an extended field trip. The following items therein can be identified: (1) a Pitot tube (invented in 1730); (2) a level and leveling rod; (3) a quadrant and ball (such as invented by Guglielmini); and (4) a wicker stool for the comfort of the note-taker of the party! One item with which Michelotti also experimented, but which does not appear in either of these illustrations, was a paddle-type meter similar to the one previously shown in Figure 18*a*.

During the 1700s, leadership in the field of hydraulics slowly shifted from Italy to France. No doubt the ample funds that the French government supplied for research on this subject did much toward creating the change. Then too, during that century, mathematics

had reached a stage where astute researchers could apply it to their hydraulic investigations.

Prominent among those who made use of both laboratory and mathematical facilities was Pierre Louis Georges Dubuat (1734-1809), a lieutenant in the Royal Corps of Engineers. The eminent engineer, writer, and educator, Hunter Rouse has provided the following translation from one of Dubuat's works revealing the state of the science as of the 1780s:

All that concerns the uniform course of the waters of the face of the earth is unknown to us; and to obtain an idea of how little we do know, it will suffice to glance over what we do not: To estimate the velocity of a river of which one knows the width, the depth, and the slope; to determine to what height it will rise if it receives another river in its bed; to predict how much it will fall if one diverts water from it; to establish the proper slope of an aqueduct to maintain a given velocity, or the proper capacity of the bed to deliver to a city at a given slope the quantity of water which will satisfy its needs; to lay out the contours of a river in such a manner that it will not work to change the bed in which one has confined it; to calculate the yield of a pipe of which the length, the diameter, and the head are given; to determine how much a bridge, a dam, or a gate will raise the level of a river; to indicate to what distance backwater will be appreciable, and to foretell whether the country will be subject to inundation; to calculate the length and the dimensions of a canal intended to drain marshes long lost to agriculture; to assign the most effective form to the entrances of canals, and to the confluences or mouths of rivers; to determine the most advantageous shape to give to boats or ships to cut the water with the least effort; to calculate in particular the force necessary to move a body which floats on the water. All these questions, and infinitely many others of the same sort are still unsolvable: Who would believe it?⁴¹

Later, among those same works Dubuat expressed the fundamental principle which has thrown wide the doors for analyzing mathematically the flow of water in conduits and open channels. David Brewster, who had himself designed a current meter as will be discussed later, described the circumstances which led to that discovery as follows:

In studying the motion of canals and rivers, it occurred to him [Dubuat] that if water possessed perfect fluidity, and flowed in a channel infinitely smooth, its motion would be constantly accelerated like that of heavy bodies descending upon an inclined plane. But as the velocity of a river is not accelerated *ad infinitum*, but soon arrives at a state of uniformity, and is not afterwards increased without some cause, it follows that there is some obstacle which destroys its accelerating force, and prevents it from impressing upon the

water new degrees of velocity. This obstacle must therefore be the viscosity of the water, which gives rise to two kinds of resistance, one, namely, which proceeds from the intestine motion of an imperfect fluid, and the other from the natural adhesion of its parts to the channel in which it flows. Our author, therefore, found it to be a general principle, "that when water runs uniformly in any channel, the accelerating force which obliges it to run is equal to the sum of all the resistances which it experiences, either from its own viscosity, or from the friction of its channel."

The result of this investigation was published in 1779, in

the first edition of his *Principes d'Hydraulique* Through the influence of M. de Fourcroy, director of the Royal Corps of Engineers, the French Minister ordered an annual sum to be put at the command of the Chevalier Buat [Dubuat], for the purpose of performing a set of experiments upon this important subject; and during the years 1780, 1781, 1782, and 1783, he was constantly occupied with these experiments. . .

In 1783, when M. Buat's experiments were finished, they were submitted to the Academy of Sciences through the minister of war, and were afterwards published in 1786,

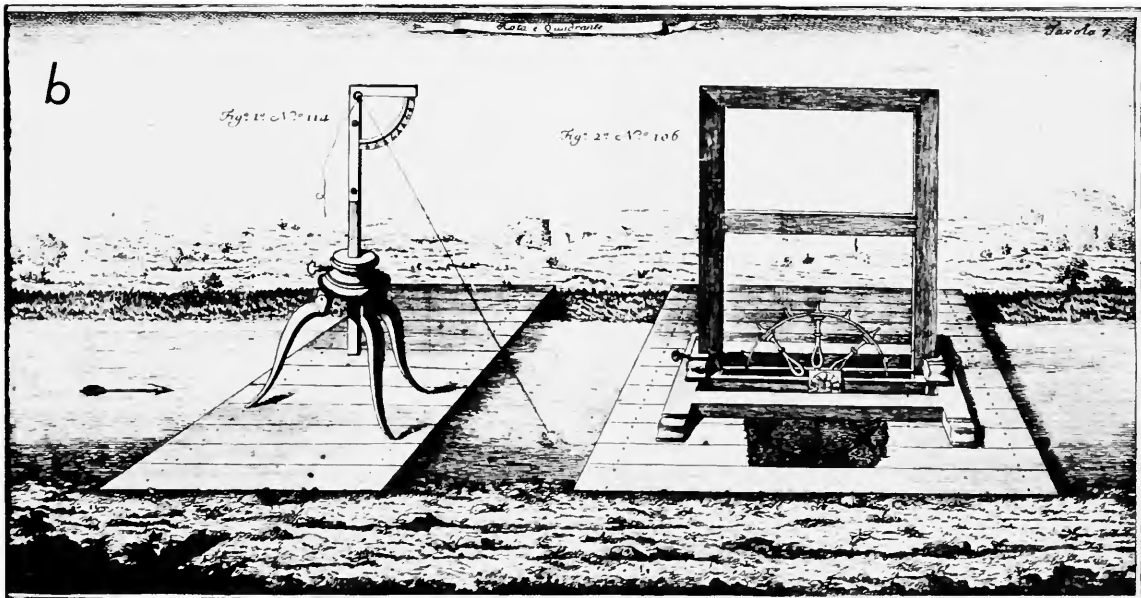
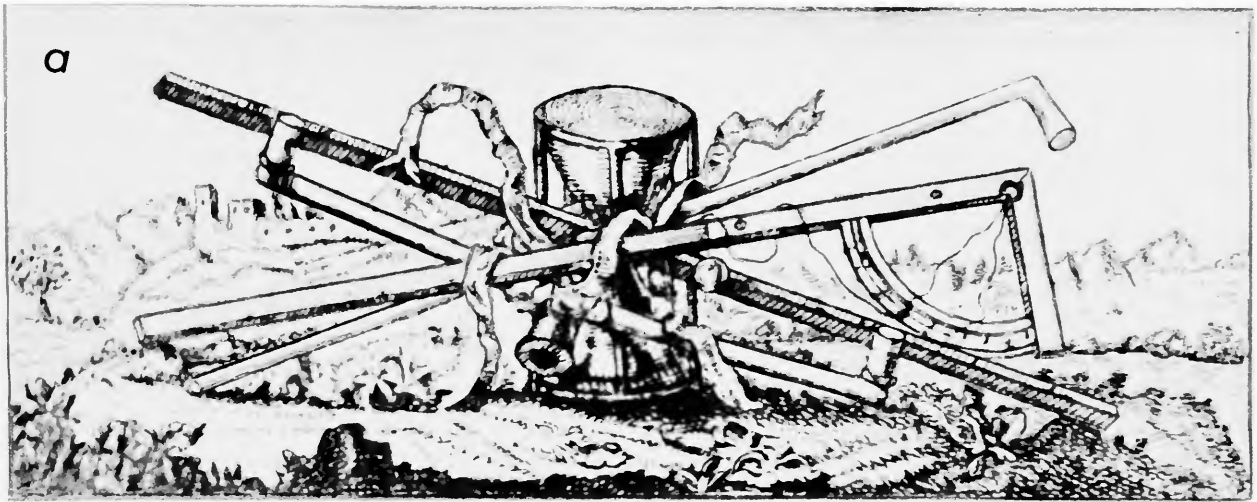

FIGURE 24.—Stream-gaging equipment: *a*, ca. 1767; *b*, Michelotti's devices, ca. 1767.
(From Michelotti, *Sperimenti Idraulici*.)

under the title of *Principes d'Hydraulique verifiés par un grand nombre d'expériences faites par ordre du gouvernement*. A third volume of this work was published in 1816 under the title of *Principes d'Hydraulique et de Pyrodynamique*.⁴²

Probably the largest item of laboratory equipment which Dubuat had occasion to use during his experiments consisted of a canal, 15 feet wide over which he arranged to have a bridge built which just cleared the surface of the water. In this canal he could "by means of a gate, produce a stream 3 feet deep, with a velocity of more than 40 inches per second."⁴³ For measuring subsurface velocities he first used a Pitot tube, but upon finding it was difficult to read because of the tendency of the water in the tubes to oscillate continually, he had a substitute made which consisted of "a simple tin tube large enough so that we may place in it a float which will indicate the elevation of the water with greater precision than when it is observed through glass."⁴⁴ The lower (bent) extremity terminated in a plane surface pierced by a small hole at its center for diminishing the oscillations in the water column. The float supported a slender rod, which extended vertically therefrom for facilitating observations on an adjacent scale.

His experience with this device led Dubuat to perform numerous experiments with devices such as shown with his portrait in Figure 25. (Note the tiny

float with its vertical rod in the second drawing from the left. By opening just one of the holes therein for each observation, he evaluated the pressure distribution across the entire face of the plate.)

Dubuat's most important laboratory facility for measuring surface velocities consisted of a wooden paddle wheel (Figure 26) similar to that used by Michelotti, but much lighter. Its rotor weighed only 11¼ ounces, and the diameter as measured from the center of one plate to the center of the one opposite it, was 2 feet. A replica of this paddle wheel is in the Smithsonian collection.

An obituary of David Brewster (1781-1868) that appeared in the 11 April 1868 issue of *Harper's Weekly* described him as "one of the greatest philosophers of our age." In addition to his having received numerous awards and academic honors, he held fellowships in the Royal Societies of Edinburgh and of London, and he was a foreign associate of the French Institute. In 1831 he became one of the founders of the British Association for the Advancement of Science. No doubt the major triumph among his many literary accomplishments was his 22-year editorship of the monumental *Edinburgh Encyclopaedia*. That encyclopedia has especial significance here because its Volume 10 contains, under the heading "Hydrodynamics," the most comprehensive and learned historical review of

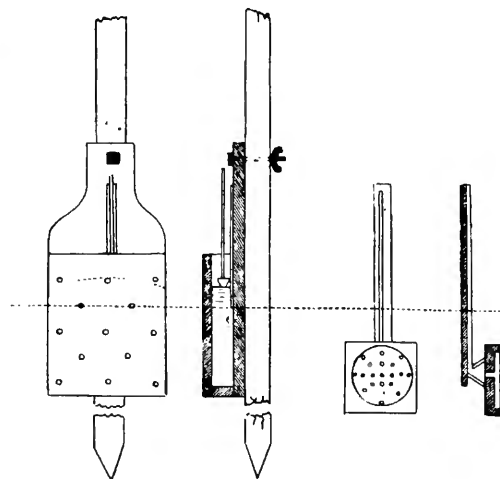
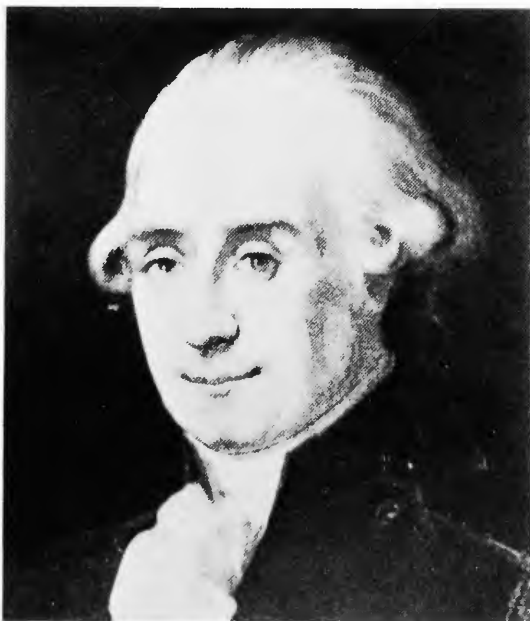

FIGURE 25.—Pierre Louis Georges Dubuat and some of his experimental models. (From Rouse and Ince, *History of Hydraulics*; courtesy of Hunter Rouse.)

that subject to have been written up to 1832, the time of its publication.

Experimentally, his major achievements were mostly concerned with polarized light and the crystals with which it could be produced. While the scientific aspects of his work thereon deserve high acclaim, the many millions of nonscientific persons who have



FIGURE 26.—Replica of Dubuat's "moulinet" for measuring the surface velocities of water in rivers and canals, ca. 1780. (NMHT 317672, photo by A. H. Frazier.)

looked into a kaleidoscope (a still popular toy that resulted from his investigations) may enjoy knowing that Brewster had invented it in 1816.

The third edition of James Ferguson's multivolume work, entitled *Lectures on Select Subjects . . .*, includes Brewster's notes on the most recent discoveries in the arts and sciences,⁴⁵ and contains the earliest description and illustration of Brewster's paddle wheel current meter (Figure 27).

To determine the velocity of water with this meter, it would be held so that just the lowermost paddles are completely immersed in the water while they faced

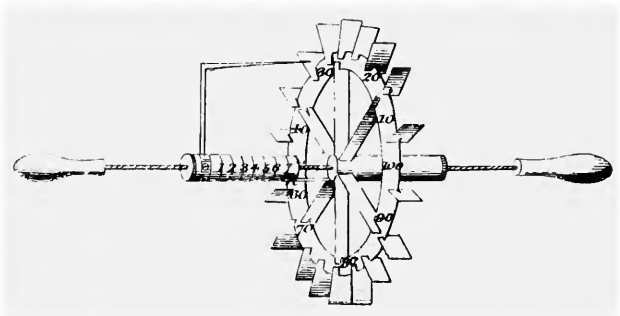
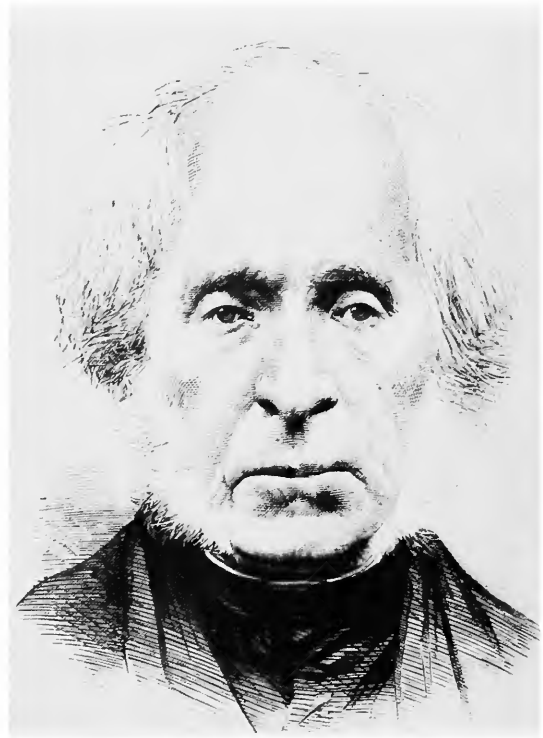

FIGURE 27.—Sir David and his paddle wheel type meter. (Portrait from Harper's Weekly, 11 April 1868; drawing from Ferguson, *Lectures on Select Subjects*.)

directly into the current. The amount of time required for the wheel to make a certain number of revolutions would then be determined, and the velocity computed therefrom, basing such computations on the assumption that the effective circumference of the wheel (that which passes through the center of each of the paddles) will travel at the same speed as the water at that location. The number of revolutions could be checked by counting the number of threads which the wheel had advanced along the threaded axle.

Although the information contained in Ferguson's *Lectures* does not make it clear as to whether Ferguson or Brewster had conceived of the idea regarding this meter, a book published by Giovambisto Mascetti about a year later, gives the credit to Brewster.⁴⁶

American Innovations

Beginning in 1830, certain paddle wheels took on much larger dimensions and a somewhat different function, that of determining the discharge of the stream directly. To be sure, the water's average velocity could be determined in the process (by dividing the discharge by the cross-sectional area at any location in the stream), but that information ceased to be of interest when the total discharge became known.

These mammoth wheels made their initial appearances in Lowell, Massachusetts, then the fastest growing industrial town in America. There, at the confluence of the Concord and Merrimack rivers, an ideal situation existed for developing water power on an unprecedented scale. A company called the Proprietors of Locks and Canals on the Merrimack River had been formed which offered to sell in package lots, entire cotton mills, complete with machinery, dormitories for the employees, and, for a continuing fee, all of the water required for its operation. The first mills sold under this plan were purchased by the Hamilton Company. The earliest thereof went into operation in 1826; the second in 1827; and the last in 1830. Samuel Batchelder who, up to 1824 had operated a small New Hampshire mill, was selected as the Company's Agent (Manager), and Ithamar A. Beard (1789-1871) (Figure 28) formerly the preceptor of an academy at nearby Littleton, was selected for its paymaster. The man who constructed the millwheels for these and all of the other early Lowell mills was John Dummer.



FIGURE 28.—Ithamar A. Beard. (From *Lowell Historical Society collection, Lowell, Massachusetts; photo by A. H. Frazier.*)

In 1830, Batchelder decided it was time to determine the overall mechanical efficiency of the Hamilton Mills, and Beard, who had spent much time educating himself as a hydraulic and mechanical engineer, was put in charge of that work. Efficiency studies require the highest order of accuracy in all of the measurements that enter into the problem, and this was especially true with respect to the streamflow measurements. None of the methods then in vogue seemed accurate enough for his purpose, so Beard, with the help of John Dummer, developed a special paddle wheel for making them so (Figure 29). The sides and bottom of the selected measuring section on the Hamilton Canal were thereupon lined with heavy planking, with a section in the bottom planks carved out to match the curvature of the wheel. The wheel itself was nineteen feet three inches in diameter, and fifteen feet broad. Only the lower one-third of it was

submerged in the water after its installation, and less than one-fourth of an inch clearance occurred between the wheel and any of the planks in the lining. The wheel was shaped like the paddle wheels on Mississippi River boats except that the compartments between successive paddles were so completely enclosed that no water could escape from one compartment into the next. Essentially all of the water therefore became trapped in the completely filled compartments on the wheel as the oncoming water caused it to revolve. The volume of water so trapped during each revolution of the wheel was readily computed. By timing the number of revolutions of the wheel during a given "run," the discharge, in cubic feet per second could easily be determined.⁴⁷ The accuracy of this method is second only to that conceived by Hero of Alexandria (Figure 3).

It is of interest to note that the *Lowell Courier* for 3 October 1840 (and for several issues thereafter), carried an advertisement headed "Ithamar A. Beard, Civil Engineer." Among the various items listed therein as services which he performed, were "measuring and computing the quantity of water supplied by streams." This is believed to be the earliest advertisement offering such services ever to have been published in the United States.

In 1841, the Proprietors of Locks and Canals decided that it would be to their best interests to know the amount of water flowing in the other canals in Lowell (Figure 30). They accordingly engaged three of the most outstanding American engineers of the time to determine by the highest authority, the quantities of water-power drawn by the several mills. They were James Fowle Baldwin (1782-1862), George

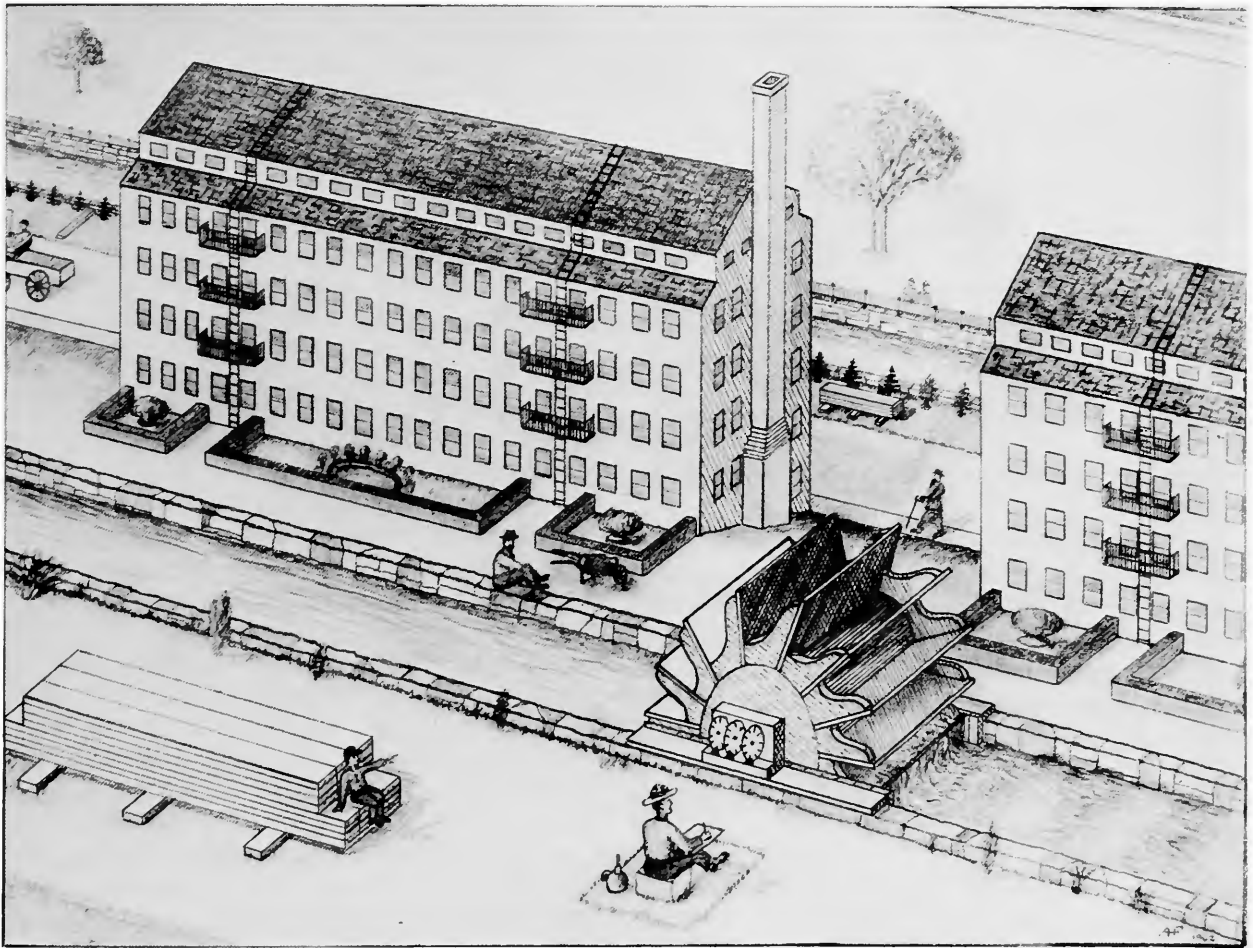

FIGURE 29.—Measuring the flow in the Hamilton Canal with Beard's paddle wheel in 1830.
(Drawn by A. H. Frazier.)

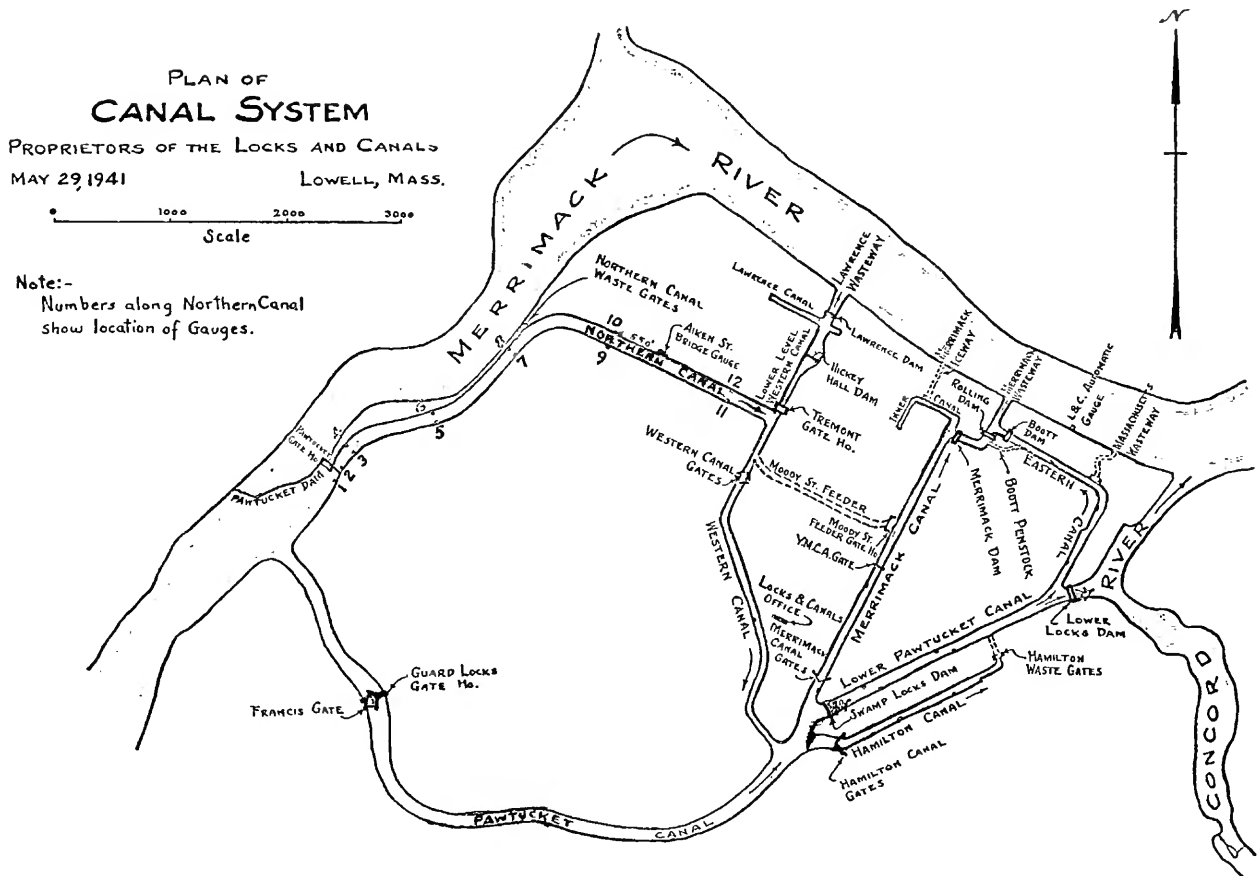

FIGURE 30.—The canals of Lowell, Massachusetts.

Washington Whistler (1800-1849), and Charles S. Storow (1809-1904). No finer group of engineers had ever previously been brought together for such an undertaking.

James Fowle Baldwin (Figure 31a) was the son of Loammi Baldwin, builder of the famous Middlesex Canal between Lowell and Boston. Dr. Parsons, in his biography of Baldwin, declared that he was surpassed by none as a scientific and practical engineer.

George Washington Whistler (Figure 31b), father of the artist, has been honored by his fellow engineers with a cenotaph at the Greenwood Cemetery in Brooklyn, New York, which carries the following inscription:

This cenotaph is a memorial of the esteem of his friends and companions Educated at the U.S. Military Academy, he returned from the Army in 1835 and became associated with William Gibbs McNeill. They were in their time acknowledged to be at the head of their profession in this country. . . .

In 1842, Whistler was commissioned by Czar Nicholas of Russia to take charge of the construction of a railroad between St. Petersburg and Moscow.

Charles S. Storow (Figure 31c) was perhaps the most highly educated hydraulic engineer in the country at that time. After graduating (at the head of his class) from Harvard in 1829, he spent several months in Loammi Baldwin's extensive engineering library in Woburn, Massachusetts, studying the English, French, and Italian books on that subject. Then, sponsored by Baldwin and the Marquis de Lafayette, he gained admission to what was then the world's leading engineering college, the *École des Ponts et Chaussées* in Paris. And after completing three years of study, he visited England to learn what he could about the new Stephenson steam locomotives which had recently been constructed there.

He returned to Boston in April 1832. Construction work on the Boston and Lowell Railroad had just begun, and he obtained a position with his good



FIGURE 31.—Three eminent engineers who measured the discharge of Lowell canals in 1841: *a*, James Fowle Baldwin; *b*, George Washington Whistler; *c*, Charles Storrer Storrow. (*a*, Courtesy of Steponas Kolupaila; *b*, from *The Illustrated American*, 25 May 1895; *c*, from *Engineering News*, 16 February 1893.)

friend, James Fowle Baldwin, the Chief Engineer in charge of its construction. When the first trial run on this railroad was made between Lowell and Boston, Charles Storrow controlled the throttle of the Stephenson locomotive. From 1836 to 1845 he was the agent (general manager) of that railroad. During the earlier years of his work thereon, much of his spare time was devoted to writing his book, *A Treatise on Water-Works*. It was published in 1835 and contained the most authoritative information then available on hydraulics from both European and American sources. It is believed to be the first book completely devoted to hydraulics ever to have been written by an American and published in America.

Another participant in that canal-measuring project was James Francis (1815-1892). He had come to Lowell with George Washington Whistler in the early 1830s at the time Whistler became engaged as Engineer of the Proprietors of Locks and Canals for the special purpose of building, in the Lowell Shops, railroad locomotives similar to those built by Stephenson in England. Two of those British locomotives were brought to Lowell for that particular purpose, a heavy and a light model. Francis' first job was to make pattern drawings of every one of their cast parts so that castings could be produced for use on the Amer-

ican counterparts thereof. When in 1837, Whistler left Lowell to finish the earlier work he had started on the Providence and Stonington Railroad, Francis remained behind. Therefore, he was present at Lowell in 1841 when Baldwin, Whistler, and Storrow began measuring the discharges in those canals.

The method these engineers adopted for measuring those discharges was identical, in every respect except one, to that which the former preceptor of the Littleton Academy, Ithamar A. Beard, had used some ten or more years earlier on the Hamilton Canal. The exception was found necessary because there were considerably larger volumes of water involved than could be handled by a single measuring wheel. They solved that problem by widening the measuring sections in the canals, and stringing as many sixteen-foot-diameter, ten-foot-wide wheels (with piers between each) as were needed onto a common shaft. Seven wheels (the largest number) were used on the Western Canal (Figure 32).

Francis, who had kept the records for this project, and who saw to it that the instructions of the Commissioners were carried out, did such a good job thereon, that at least two members of the Commission recommended that he be placed in charge of the

future hydraulic work of the organization. It seems likely that the experience he acquired in hydraulics on this occasion is largely responsible for his having

pursued that subject diligently, and ultimately becoming one of the nation's most highly respected hydraulic engineers of his generation.

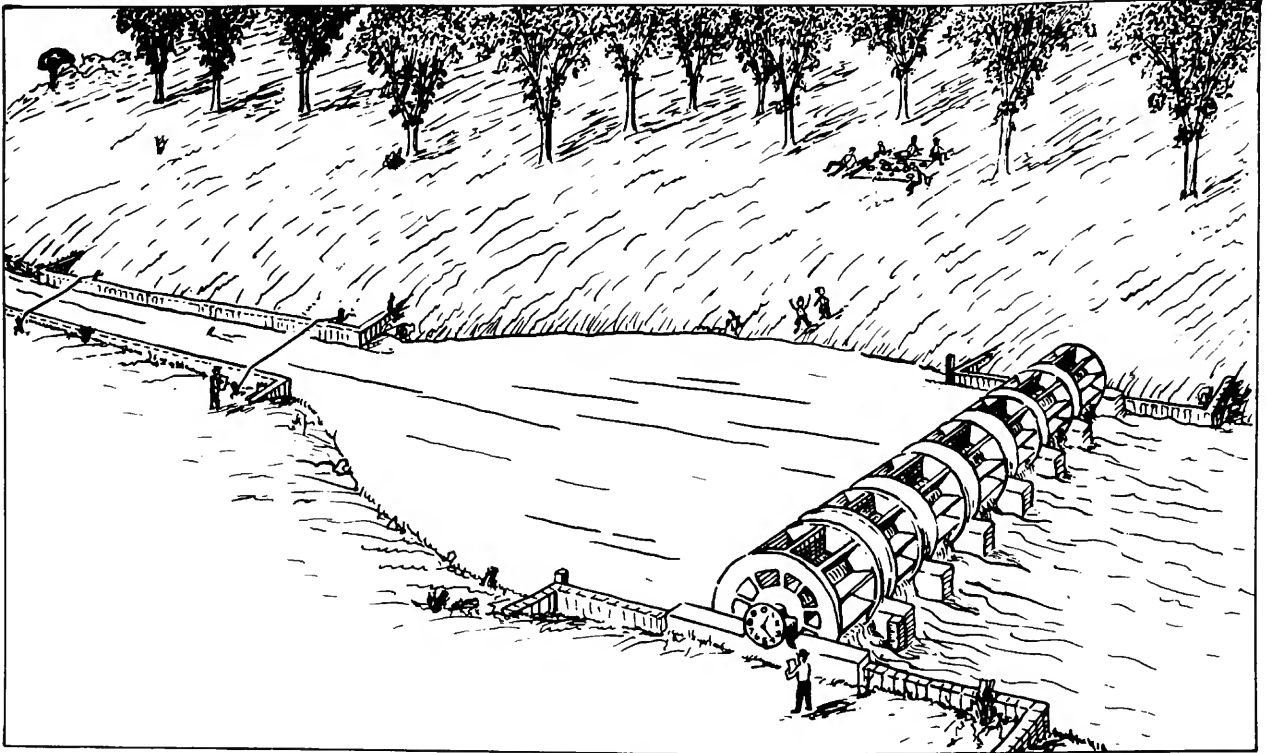

FIGURE 32.—Discharge measurement of the Western Canal in Lowell, Massachusetts, as conducted in 1841-1842 by Baldwin, Whistler, and Storrow. (Drawn by John Allcott and A. H. Frazier.)

TUBING APPLICATIONS

It has been mentioned previously that adjutages extending through the walls of Rome's water-supply reservoirs had cross-sectional areas of various multiples of "quinariae," and that such areas were the accepted unit of measure for the amount of water delivered to a consumer. They represented the earliest known use of tubing for measuring the flow of water. Without supplementary data, such as the head of water above them, and suitable mathematics, this "quinaria" method was, to put it mildly, extremely erratic. Despite its faults, however, the method per-

sisted to modern times. In fact it was still common practice in America during the late 1800s to measure flowing water by its modern equivalent, the "square inch."⁴⁸

The Pitot Tube

During the two thousand years between 300 B.C. and A.D. 1700, many studies had been made on how to evaluate the flow of water through pipes, orifices,

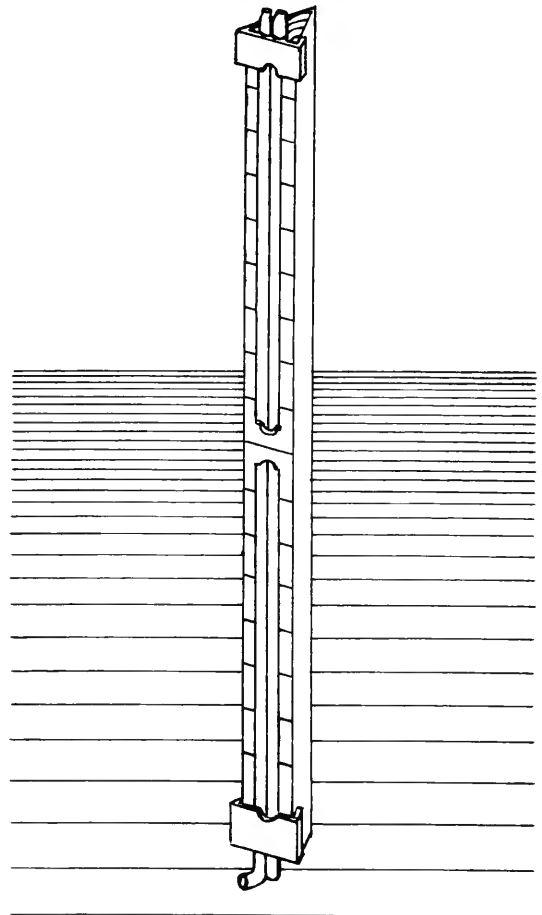

FIGURE 33.—Henri de Pitot and his tube. (Portrait from Rouse and Ince, *History of Hydraulics*; sketch by A. H. Frazier after description by Pitot, "D'Une machine pour mesurer la vitesse des eaux courantes.")

nozzles, etc., but it was not until near the end of that period that significant progress was made. In 1732, Henri de Pitot (1695-1771) (Figure 33) introduced his "tube" which, although it was especially intended for use in open channels, became useful in closed conduits. His paper thereon was presented before the French Academie Royale des Sciences, Paris, on 12 November 1732.⁴⁹

The original device consisted merely of two slender glass tubes mounted side by side onto one of the three flat surfaces of a triangularly shaped wooden rod. The lower inch or two of the first tube was bent at 90 degrees to allow it to point directly upstream while the main portion thereof was held vertically. The second tube was straight throughout its entire length, with its lower end at the same level as the bent section of the first tube (Figure 33).

Water entering the open end of the bent tube would cause the column of water in that tube to rise above the level of the water in the surrounding stream as a result of the kinetic energy in that filament of water being converted into a pressure head. No corresponding rise would take place in the straight tube. The differences in the elevations of water in those two tubes accordingly became a function of the velocity of the oncoming water.

Rouse has translated a comment by Pitot about his invention as follows:

The idea of this machine is so simple and natural that the moment I conceived it, I ran immediately to the river to make a first experiment with a glass tube, and the result confirmed completely my anticipation. After this first experiment, I could not imagine that such a simple and at the same time very useful thing could escape so many skilled people who have written and worked on the motion of water.⁵⁰

Pitot's method of computing the velocity from the readings obtained from his tubes was not entirely like that presently in use, but it at least led the way to more accurate methods.

As is true of almost every invention, later experimenters attempt to improve on their predecessor's device. For example, Henri P. G. Darcy, circa 1858, replaced the straight tube with one on which the lower end was bent 90 degrees in the downstream direction. This caused a draw-down to occur in the elevation of its column of water, thus doubling the reading made on the scale, and reducing probable errors entering into such readings. The invention, however, still retains its original characteristics and Pitot-type tubes are commonly used today in hydraulic



FIGURE 34.—A Pitot tube intended for use in hydraulic laboratories. This model was originally owned by the Proprietors of Locks and Canals of Lowell, Massachusetts. (NMHT 314776, Smithsonian photo 74335.)

laboratories (Figure 34) with only slight modifications. The tubes are made of metal, rather than glass. Since this material is not transparent, it is impossible to read the height of the water column directly; flexible tubes are connected from the metal tubes to a nearby manometer, from which the readings are made with greater facility and accuracy.

Although current meters of the conventional type have been found more practical for use on rivers, Pitot tubes have several characteristics that are advantageous for laboratory work and for certain special applications. For example, no timing is required in connection with an observation; they disturb the natural flow of the water much less than most other devices; and they are capable of collecting data from

a much smaller point in the cross-section of the stream.

The Bentzel Velocity Tube

The Bentzel velocity tube was developed in 1932 by Carl E. Bentzel, then Research Assistant at the U.S. Waterways Experiment Station at Vicksburg, Mississippi. Three different models thereof, as manufactured in the 1940s by Leupold and Stevens, Inc., are shown in Figure 35a. Like the Darcy model, both tubes are bent at their lower ends, with one pointing upstream, the other, downstream; but differ in that they are connected at the top so that the water can

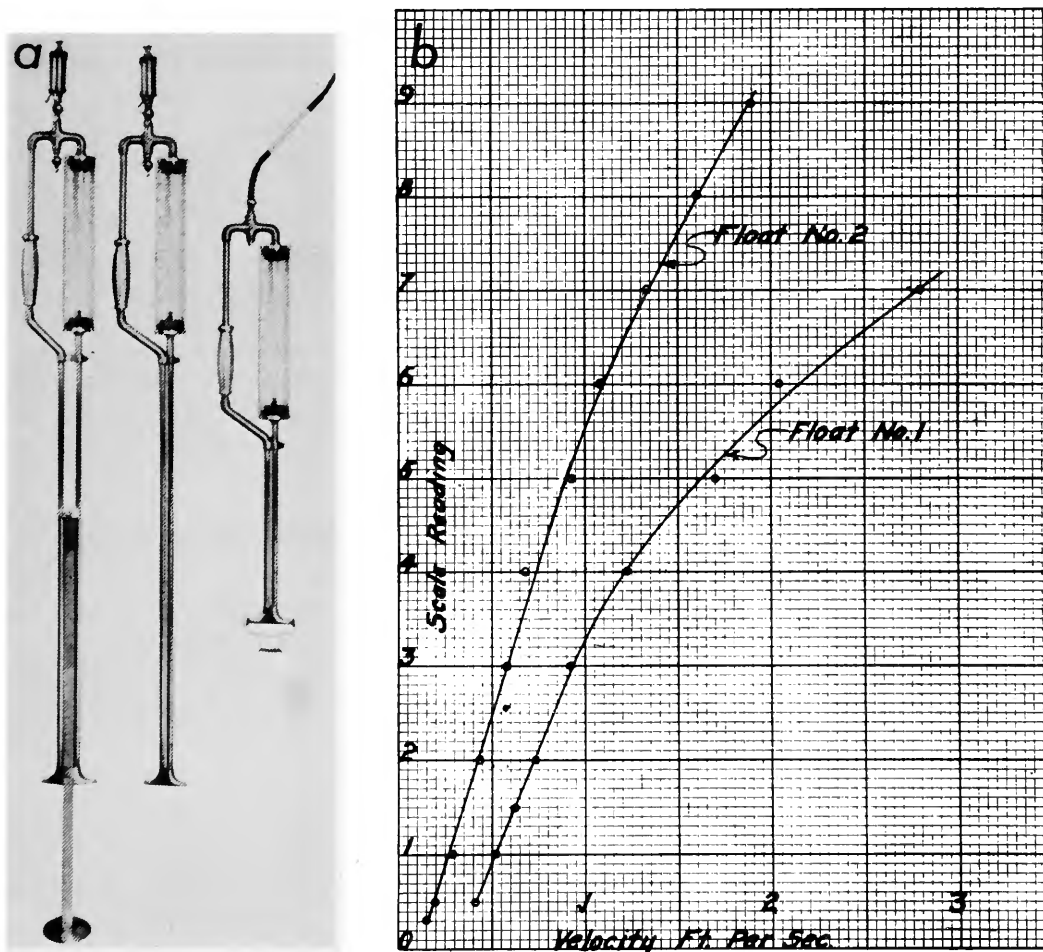

FIGURE 35.—a, Three models of Bentzel velocity tubes as manufactured in the 1940s by Leupold and Stevens, Inc.; b, sample rating curves for a Bentzel velocity tube. (From Leupold and Stevens catalog, ca. 1940)

flow upward through the front tube and continue downward through the other. At some point along that path is a long tapered glass tube within which the water-velocity has to vary (inversely) with the increase in diameter. A tiny loose float, slightly heavier than water, rests at the bottom (narrower) end of that tube when the instrument is submerged in still water; but when it is in flowing water, the float is pushed upward by the oncoming water until a balance occurs between the velocity and gravitational forces acting on it. Upon its arrival at that resting point, the operator reads its height on an adjacent scale, and converts that reading into a corresponding velocity value obtained from a rating of the instrument.

Another model based on this same idea has an inverted tapered section and a float that is lighter than water. The float tends to remain near the top of that section until pushed downward by the oncom-

ing water until the equilibrium point is reached. A similar rating is needed to convert that point, as read on the scale, to the appropriate velocity value. Instruments such as this are discussed at considerable length in the chapter on "Variable Aperture Flow Meters" in Troskolanski's *Hydrometry*.⁵¹

A variation on the use of tubing in current meters is of historical interest, though it was not in the main line of development. On 31 August 1806, Vittorio Fossombroni had presented, in behalf of Francesco Focacci (fl. 1806), a paper before the Italian Academy of Sciences. It was entitled, "Per Investigare la Celerita' Dell'Acque Correnti," and contained a report on the distribution of water velocities in a canal, as investigated by Focacci with his two current meters (Figure 36). It will be seen that horizontal tubing had been used as parts of both models, a unique application for such instruments.

One (Figure 36a) contained, in the box below the

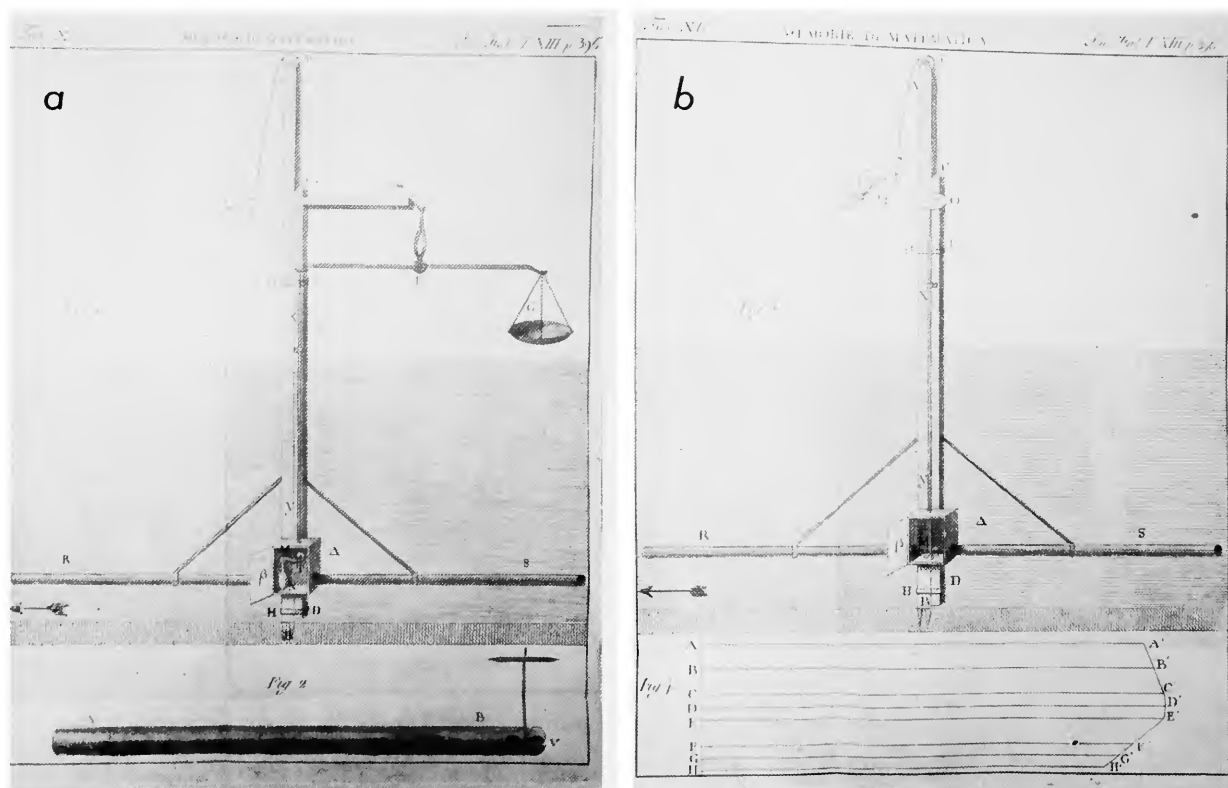

FIGURE 36.—Focacci's two current meters, 1806: a, balance scales are used to measure the force required to open the flap valve within the submerged box; b, pointer enables the operator to count and time the revolutions of the rotor within that instrument's box. Bottom of b is a vertical-velocity curve of the canal being studied, the earliest known publication of such a curve. (From Focacci, "Per Investigare la Celerita' Dell'Acque Correnti," page 396, plates 11, 12.)

water surface, a flap valve that covered the inner end of the downstream tube. Observations were made of the minimum weight necessary on the pan of the balance in order to open that valve. A comparison of this model with Darcy's version of the Pitot tube is of interest in that the weight required to open the flap valve (assuming the same size tubing were used) would be equal to the difference in weights of the two columns of water in the Darcy tube. In Focacci's meters, the force is a mechanical one, whereas in the other it is a hydraulic one.

On Focacci's other instrument (Figure 36b), either a cup-type or an "S-type" rotor replaced the valve mechanism. The axle thereof extended upward to the top of the apparatus where a pointer was fastened to it, which enabled the operator to count (and time) its revolutions.

The Venturi Tube

In 1797, Giovanni Battista Venturi [J. B. Venturi] (1764-1822), Professor of Natural History at Modena, published two works, entitled *Essai sur les ouvrages physico-mathematiques de Leonard de Vinci* and *Experimental Inquiries Concerning the Principle of the Lateral Communication of Motion in Fluids*, both originally in French. The first brought to public attention the wealth of scientific data (including hydraulics) in Leonardo's notebooks and focused interest on his achievements as a scientist, as distinguished from that of an artist—an interest that has never since abated.

In 1837, the second of Venturi's publications was translated into English by a civil engineer, Thomas Tredgold, in his *Tracts on Hydraulics*. By means of laboratory equipment, such as was previously designed by the Marquis Giovanni Poleni, Venturi studied the manner in which water emerged from a constantly filled tank through different types of outlets. One such outlet of his own design, to which he had attached three manometer tubes, is shown along with Venturi's portrait in Figure 38. This particular design of the tube bearing his name, allows any volume of water flowing through water mains to be metered continuously without using instruments that would interfere with the flow.

Little or no effort was made to adapt Venturi's design to any practical apparatus until 1888, when an outstanding American hydraulic engineer, Clemens

Herschel (1842-1930) exploited it to develop a device for measuring the amount of water flowing through pipes. In recognition of Venturi's experiments, Herschel named his device a "Venturi Tube." Tens, if not hundreds, of thousands of Venturi tubes are presently in use throughout the world. Herschel was

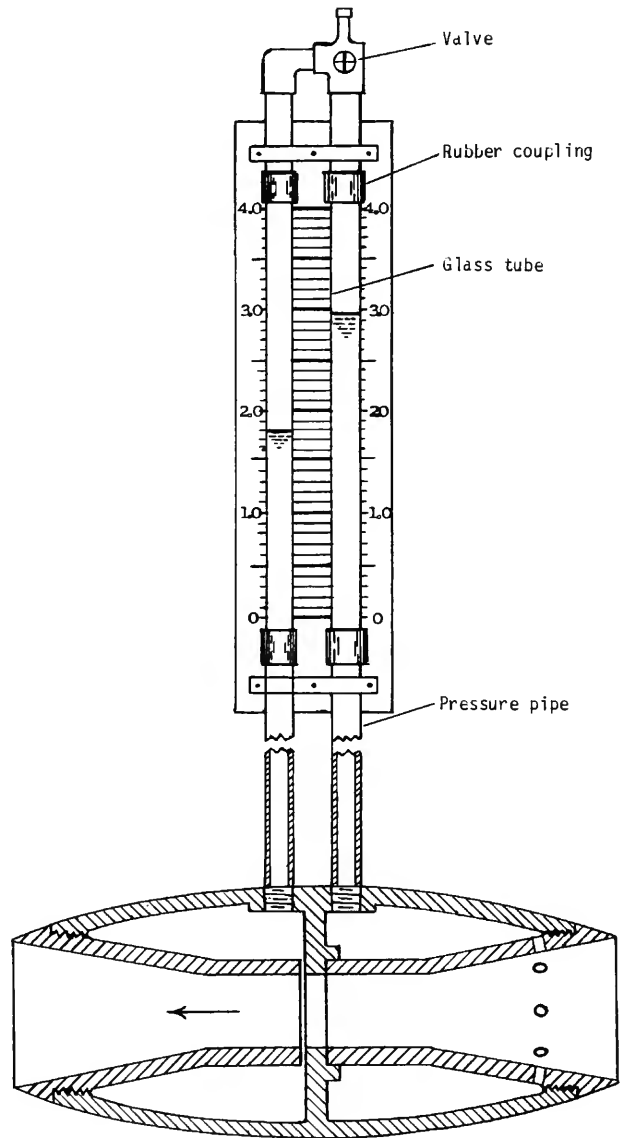

FIGURE 37.—The Venturi element (below) and manometer from Aggeler's current meter. (Redrawn by A. H. Frazier after Aggeler, "Design of a Venturi Type Current Meter.")

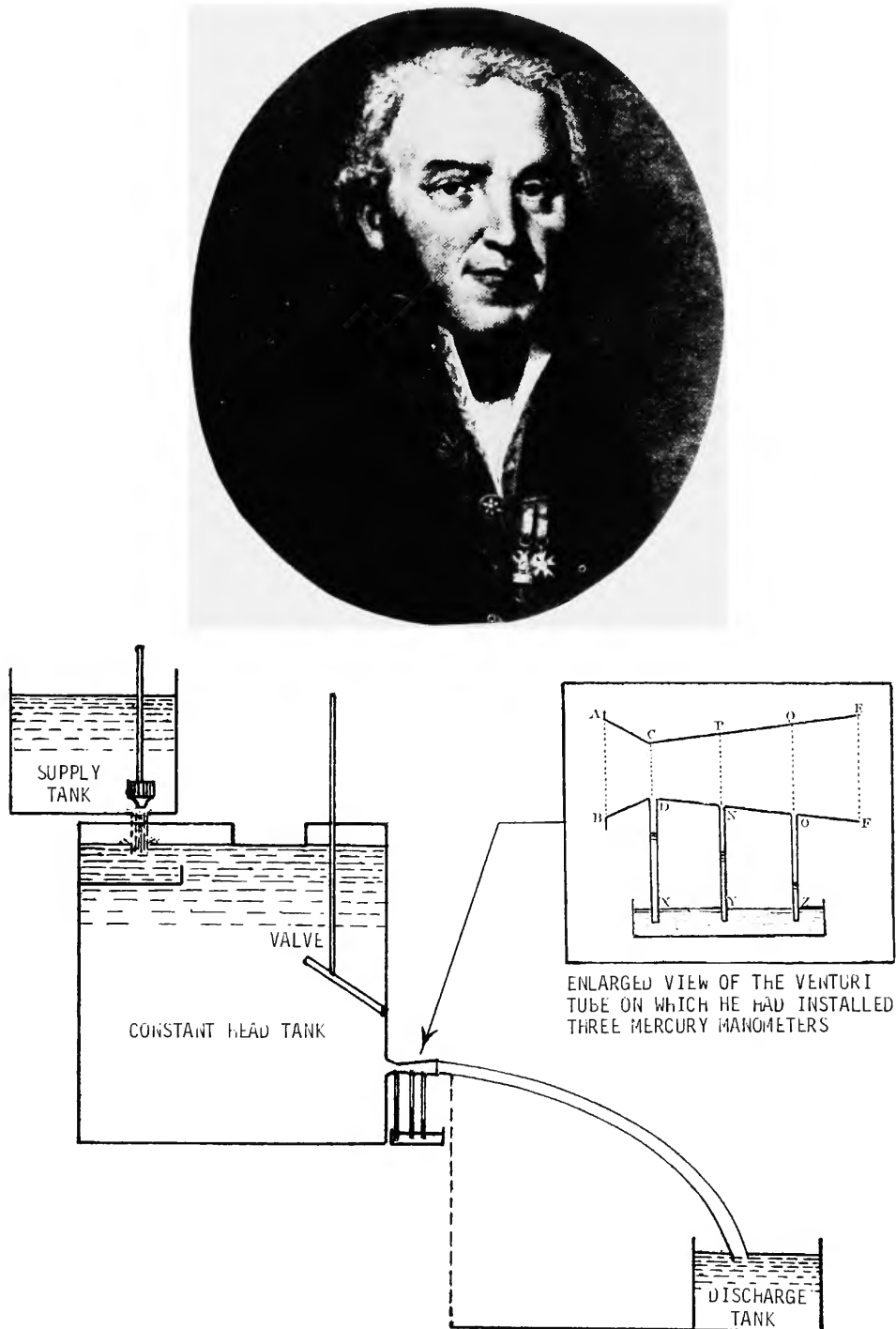

FIGURE 38.—Giovanni Battista Venturi and schematic of equipment used to test how rapidly the various types of outlets would permit filling of the lowermost (discharge) tank. The “winner” (insert) was ultimately known as the “Venturi tube.” (Portrait courtesy of Hunter Rouse; schematic adapted from Venturi, “Experimental Inquiries.”)



awarded a patent (U.S. 381,373) for it on 17 April 1888. His photograph, and a photograph of the first commercial model thereof (built for use in a water main in Newark, New Jersey, in 1892), are presented in Figure 39.

Inevitably, someone was bound to devise a current meter embodying the principles discovered by Venturi. Several of these meters are known, but only the first thereof is described here. It was conceived in 1926 by one Cecil Aggeler, then an engineering student at the University of California. His bachelor's thesis was

FIGURE 39—Clemens Herschel and his first commercial model of the Venturi tube. (*Courtesy of Steponas Kolu-paila.*)

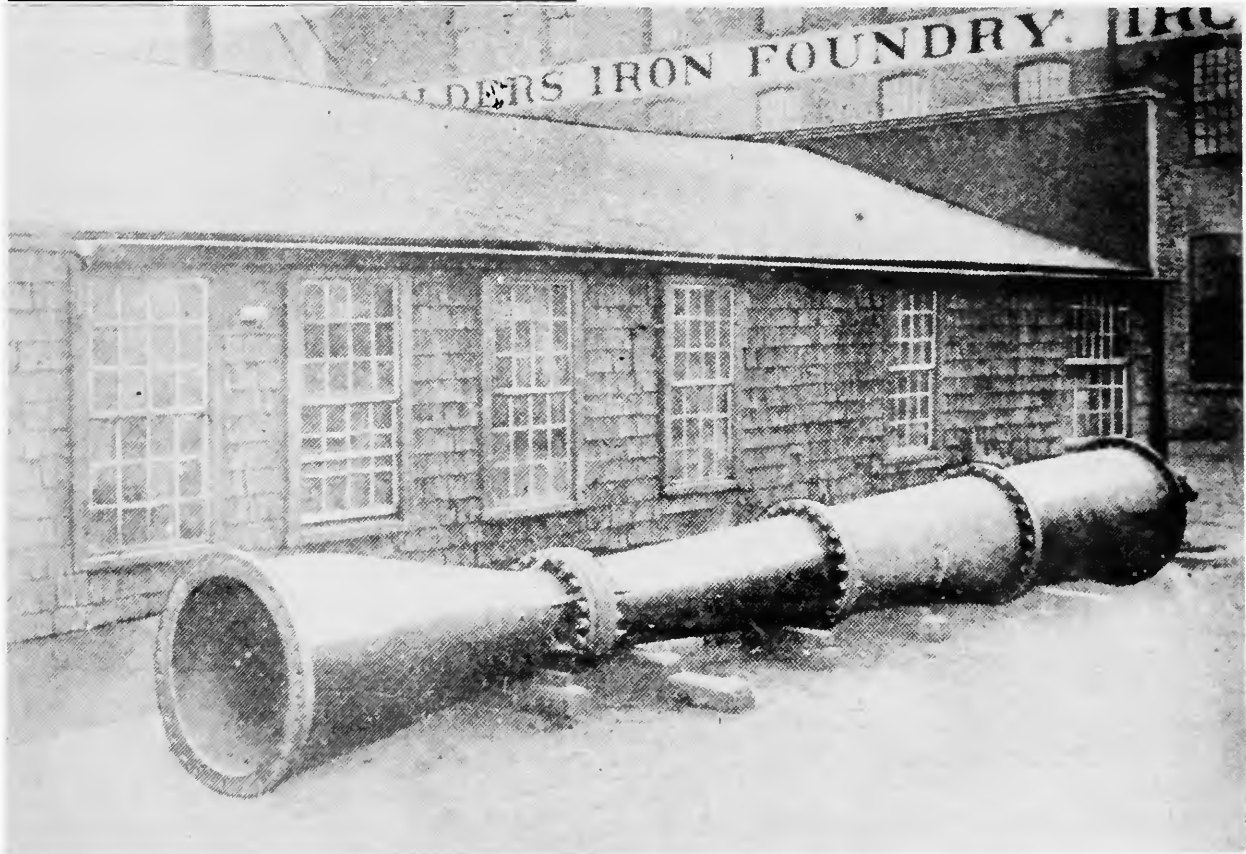

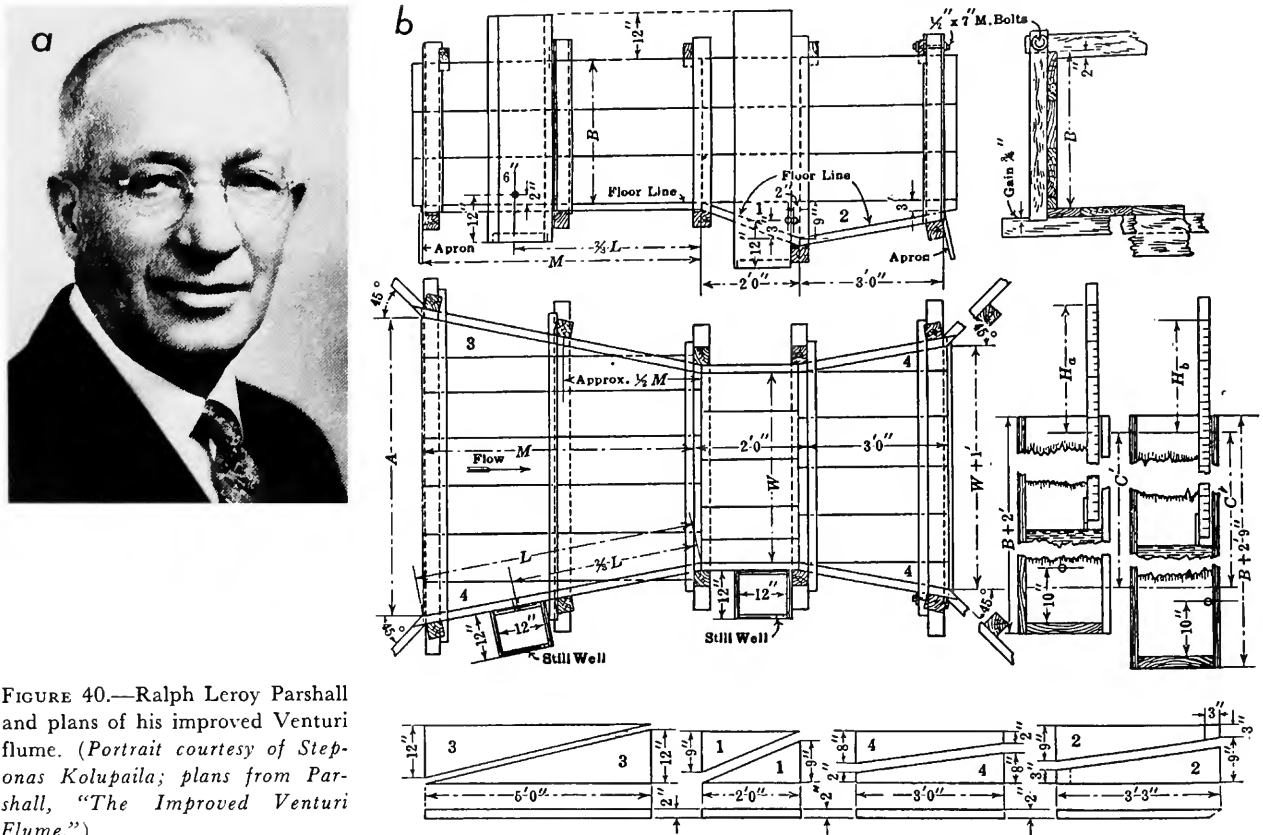

FIGURE 40.—Ralph Leroy Parshall and plans of his improved Venturi flume. (Portrait courtesy of Stephanas Kolupaila; plans from Parshall, "The Improved Venturi Flume.")

entitled, "Design of a Venturi Type Current Meter." The device consisted on an 8-inch-long cast aluminum tube with a Venturi-shaped opening through the center. The hollow space between its inner and outer walls was divided into two compartments, one of which communicated with the water flowing through the throat of the Venturi, the other with the water near the entrance thereof. The handle consisted of two small-diameter pipes which were connected, respectively, with each of those compartments. Glass tubes forming a manometer were fastened onto the tops of those pipes, and the water was drawn up to the elevation at which readings could be made of the relative heights of the two columns by evacuating most of the air in those pipes.

Drawings of that manometer and of the Venturi portion of this apparatus, appear in Figure 37.

Between 1915 and 1926, Victor Mann Cone (1883-?), Carl Rohwer (1890-1959), and Ralph Leroy Parshall (1881-1959), all irrigation engineers

of the U.S. Department of Agriculture, and connected more or less consecutively with the Colorado Agricultural Experimental Station at Ft. Collins, each wrote articles promoting the use of Venturi-type flumes for measuring the volume of water flowing in irrigation ditches. The most successful of such flumes was designed by Parshall (Figure 40) and was described in his article, "The Improved Venturi Flume."⁵²

Such flumes have been built in all sizes ranging from large permanent concrete or wooden flumes, intended for obtaining continuous records of the flow in large canals, to small portable sheet-steel models, which some hydrographers carry about like current meters for making measurements of very small streams. Perhaps the most up-to-date discussion on this subject is in *Technical Note No. 117: "Use of Weirs and Flumes in Stream Gauging,"* published in 1971 by the World Meteorological Organization, a specialized agency of the United Nations.

THE LONGITUDE CONTEST

In 1714, several captains of her Majesty's ships, merchants of London, and commanders of merchantmen, presented a petition to the House of Commons, claiming that a method for discovering the longitude of ships while they were at sea was of extreme importance to Great Britain for the safety of its Navy, its merchant ships, and for the improvement of its trade. For want of it, they contended, many ships had been delayed in their voyages, and many lost; and some persons might conceive of suitable methods and prove them before the proper judges. A committee was accordingly established to consider the subject. Among those who presented evidence before that committee was Sir Isaac Newton. He suggested that large sums of money be offered for the most acceptable solutions. In consequence thereof, Parliament passed an Act "for providing a Publick Reward for such Person or Persons as shall discover the Longitude at Sea. 12 Anne. Stat. 2. cap. 15."⁵³ The amount of the reward was graded in amount according to the degree of accuracy achieved:

£10,000 for a method accurate within 1 degree of longitude,
 £15,000 for accuracy within 40 minutes,
 £20,000 for accuracy within 30 minutes.⁵⁴

The administration of this statute was entrusted to commissioners known as the Board of Longitude.

De Saumarez' Ships' Logs

Among those who entered the contest was one Henry De Saumarez (fl. 1715), a member of one of the most prominent families on the Island of Guernsey. He failed to win any of the prizes, but he did accomplish much of historical interest. (No award whatsoever was made until 1762, when John Harrison obtained the maximum prize for the performance of his No. 4 marine timepiece on a voyage to Jamaica.) The De Saumarez entries consisted of two radically different types of ships' logs which he called "Marine Surveyors" (Figure 41). He described them as having been "contrived for the mensuration of the way [velocity] of a ship in the sea more correctly than by the log or any other method used for that purpose."⁵⁵ Although not mentioned in his claims, his logs were also used as

current meters for measuring the velocity of the water flowing in rivers.

The Log with a Vertical Axis

There is a practice presently in vogue of dividing current meters (and ships' logs) into two major categories, namely those which have vertical axes, and those which have horizontal axes. Although De Saumarez' 1715 models bear very little resemblance to their modern counterparts, both of them fall within those categories. The model with the vertical axis appears in Figures 41*a, b*. Its rotor has four spokes at the ends of which he had fastened (by means of hinges) flat pallets arranged in such a manner that the oncoming water would strike against their broad flat surfaces during the "driving" phase of its revolution; but during the remaining portion of that revolution, it would strike against only the narrow edge of the pallet. The unequal forces thus created would produce the desired rotary motion. A replica of this rotor, from the Smithsonian collection of current meters, appears in Figure 42.

De Saumarez obtained King George I's permission to perform experiments with his "machine" on the quiet waters of the canal in St. James Park in London. There he became satisfied that the rotor would make one revolution while the boat traveled a particular distance, regardless of the speed at which the boat was moving. After having satisfied himself in that respect, he adjusted the length of the spokes on the rotor until ten feet of travel would produce exactly one complete revolution.

Whether this principle of operation was borrowed from some previous invention, or rediscovered independently by De Saumarez is not known. It is known, however, that Edme Mariotte had described an old Chinese windmill that operated on much the same principle. Figure 43 depicts a model of either an anemometer or a windmill which also operates on this principle.⁵⁶ It may be noted from Figure 41*a* that a large dial constituted an important part of this equipment. De Saumarez explained its purpose as follows:

A Dial, which being placed anywhere on Board of a Ship, will by Correspondence with a small Wheel moving under Water, and a little Bell striking with the said Dial, curiously

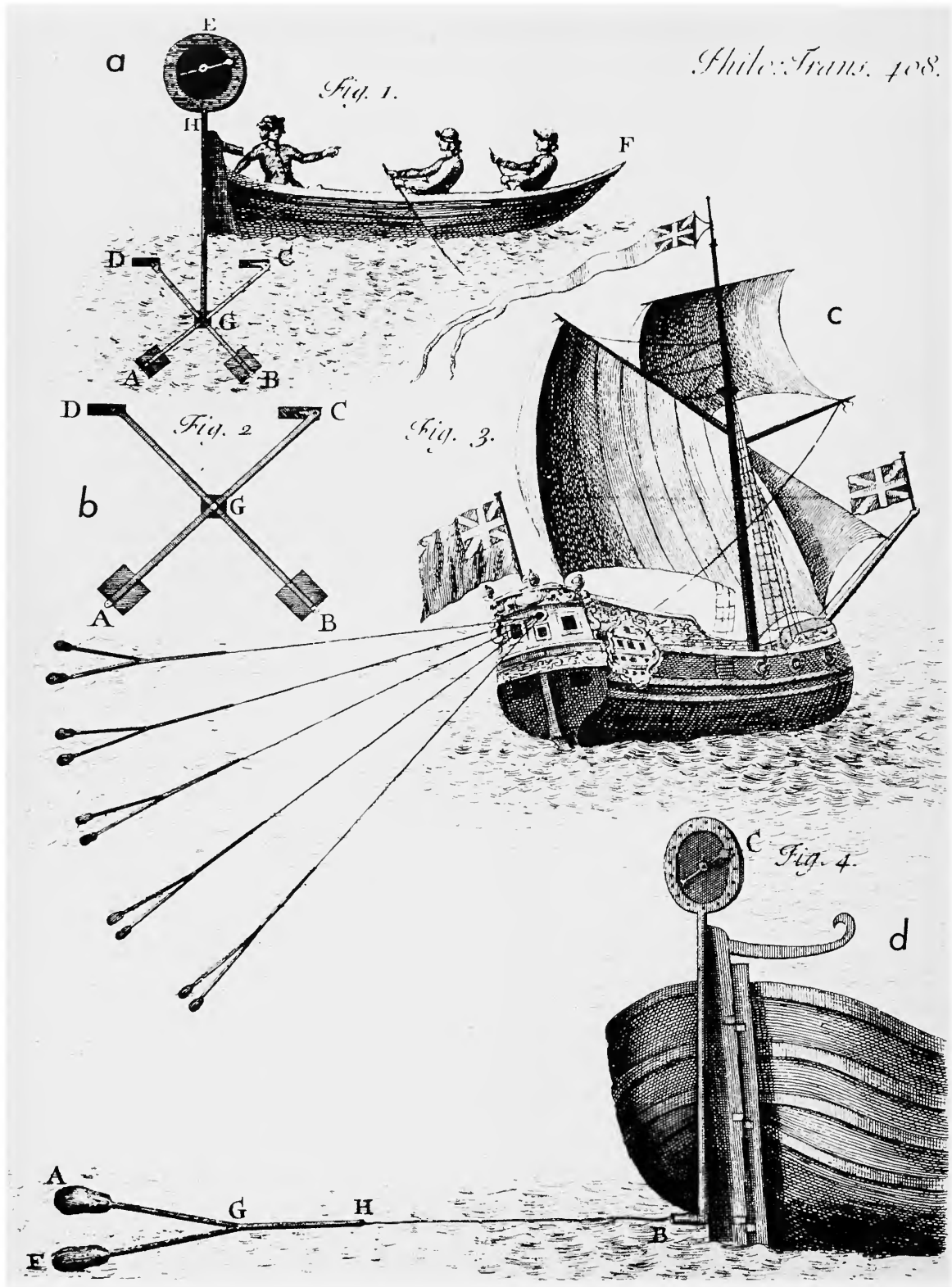

FIGURE 41.—De Saumarez' ships' logs: *a, b*, vertical-axis model; *c, d*, horizontal-axis model.
 (From De Saumarez, "III. A Further Account of a New Machine," figures 1-4.)

demonstrate the Geometric Paces, Miles, or Leagues which the ship hath run; which being applied in a proper manner, will be of little or no Hindrance to the Course or Sailing of the Ship. The said Wheel shall turn in any depth of the Sea, so that no storm, nor rough Sea, nor the violent Motion of the Ship will alter, hinder, nor stop the regular Working thereof, but the Swiftness and Slowness of the Ship shall be seen and heard by the striking of the little Bell in the said Dial.⁵⁷

Some of the difficulties that De Saumarez encountered in his effort to get the authorities to give consideration to his entries in the "longitude contest" will be described later (pp. 46-47). Although that effort was not successful, a considerable amount of discussion, including illustrations of his devices, appeared later in volumes 33, 34, and 36 of the *Philosophical Transactions of the Royal Society of London*.⁵⁸

One of the articles (*Philosophical Transactions*, volume 34) contains several tables showing the speed of the currents in the Thames Estuary as the tides ebb and flow therein. Two pages of those tables appear in Figure 44. De Saumarez obtained the data for those tables with his vertical-axis current meter. The tables are believed to contain the first of such velocity data ever to have been published.



FIGURE 42.—Replica of De Saumarez' rotor, which was used on his vertical-axis ships' log, ca. 1715. (NMHT 321481, Smithsonian photo 75593.)

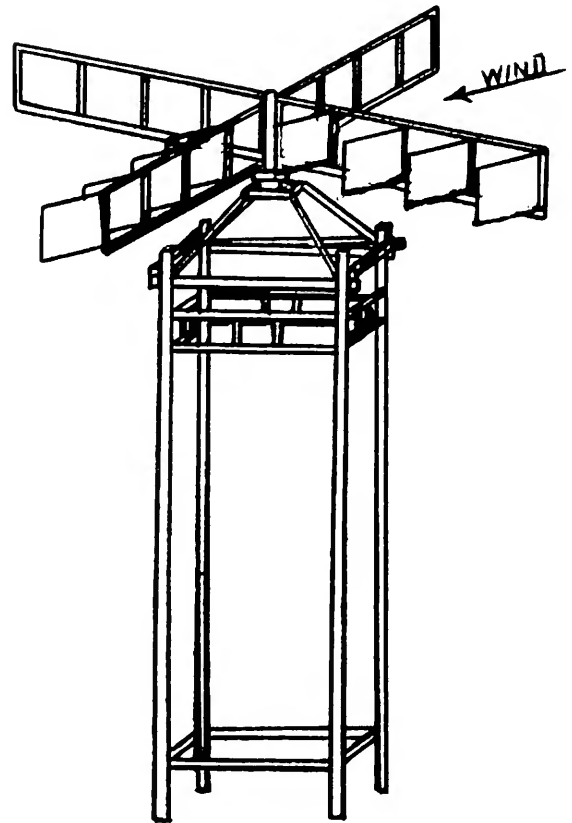

FIGURE 43.—A sketch of an instrument that appears in a painting entitled, *The Paris Academy of Science—A Visit by Louis XIV*. This device, a forerunner of De Saumarez' ships' logs, was doubtless a model of either a windmill or an anemometer. (Redrawn by A. H. Frazier, from Wolf, *A History of Science*, opposite page 63.)

Finding a correct designation for the type of rotor used on De Saumarez' vertical-axis model has not met with too much success. An article by Arthur T. Safford, a former Engineer of the Proprietors of Locks and Canals at Lowell, uses an expression, "flutter wheel"⁵⁹ to describe a mill wheel that seemed to operate on the same principle. It seems to fit the De Saumarez device, but it is not confirmed in the third edition of *Webster's New International Dictionary*.

The Log with a Horizontal Axis

One of the difficulties encountered with the vertical-axis equipment was a tendency for weeds and fibers to become entangled with the rotor. To overcome this

III. A T A B U L A R Account, shewing the Strength and gradual Increase and Decrease of the Tides of Flood and Ebb in the River *Thames*, as observ'd in *Lambeth Reach*, off of *Manchester Stairs*, and in the Middle of the River, with a new Instrument call'd the *Marine Surveyor*, on the 9th of *June*, 1720; It being then Full Moon, and consequently a Spring Tide. The Movement of the *Machine* 14 Inches under Water.

F L O O D .					
The Time of Flood.	The Depth of the River,	The Run of the Current in every 15 Min.	The whole Run of the Current to the Times express'd in the first Column.	The same reduced to Statute Miles of 5280 feet, or 528 Revolutions of the Machine.	The Reduction into English maritime Miles of 6000 feet, or 600 Revolutions.
H. M.	ft. In.	Feet.	Feet.	M. Pts. Rev.	M. Pts. Rev.
15	5	110	110	11	11
30	6	590	700	70	70
45	6 9	1100	1800	4 4/5 48	30
1	7	1400	3290	4 1/2 55	29
1 15	8	1870	5160	4 3/4 120	66
30	9	2230	7390	1 1/2 79	139
45	10	2500	9890	1 1/2 65	89
2	11 6	2660	12550	2 1/4 67	55
2 15	13	2730	15280	2 3/4 76	28
30	14	2740	18000	3 1/2 86	2
45	14 9	2720	20740	3 1/2 94	124
3	14 9	2570	23310	4 1/4 81	81
3 15	14 10	2410	25520	4 1/4 45	35
3 30	14 9	2220	27550	5 1/2 66	35
45	14	1900	29340	5 1/2 62	134
50	13 9	1300	29640	5 1/2 75	147

E B B .					
The time of Ebb.	The depth of the River.	The Run of the Current in every 15 Min.	The whole Run of the Current to the Times express'd in the first Column.	The same reduced to Statute Miles of 5280 feet, or 528 Revolutions of the Machine.	The reduction into English maritime Miles of 6000 feet, or 600 Revolutions.
H. M.	ft. In.	Feet.	Feet.	M. Pts. Rev.	M. Pts. Rev.
15	12 9	280	280	28	28
30	12 3	1140	1420	10	142
45	11 10	1900	3320	68	32
1	11 4	2080	5400	12	90
1 15	11 2	2120	7520	1 1/2 92	2
30	10 9	2120	9640	1 1/2 40	64
45	10 4	2170	11810	2 1/2 125	131
2	10	2130	13940	2 1/2 74	44
2 15	9 6	2060	16000	3 1/2 16	100
30	9 4	2040	18040	3 1/2 88	4
45	9	2020	20060	3 1/2 26	96
3	8 9	1910	21970	4 1/2 85	97
3 15	8 6	1900	23870	4 1/2 11	137
30	8 3	1910	25780	4 1/2 70	28
45	8	1860	27640	5 1/2 124	64
4	7 9	1810	29450	5 1/2 41	95
4 15	7 3	1780	31230	5 1/2 87	133
30	7	1690	32920	6 1/2 124	142
45	6 6	1620	34540	6 1/2 22	4
5	6 3	1570	36110	6 1/2 47	11
5 15	6 3	1570	37680	7 1/2 74	18
30	6	1570	39240	7 1/2 97	25
45	6	1560	40810	7 1/2 121	31
6	5 9	1550	42360	8 1/2 12	36
6 15	5 6	1500	43860	8 1/2 30	36
30	5 3	1460	45320	8 1/2 44	32
45	5	1410	46770	8 1/2 57	27
7	4 9	1410	48200	9 1/2 61	20
7 15	4 6	1400	49600	9 1/2 76	10
30	4 3	1380	50980	9 1/2 83	143
45	4 1	1340	52320	9 1/2 84	232
8	4	1370	53600	10 1/2 79	109
8 15	4 0	1300	54810	10 1/2 121	1
30	3 11	1210	56010	10 1/2 10	43
45	3	1170	57200	10 1/2 70	83
9	4	1150	58300	10 1/2 108	120
9 15	4 1	1100	59400	10 1/2 0	1
30	4 3	1070	60500	10 1/2 11	27
45	4 3	1050	61600	10 1/2 46	60

FIGURE 44.—Data compiled by Henry De Saumarez with his vertical-axis ship's log, showing the velocities in the Thames Estuary at the ebb and flood tides on 8 June 1720. These are the earliest known published data of this nature. (From De Saumarez, "IV. Observations upon the Tides in the River Thames," pages 69-70.)

tendency De Saumarez designed a horizontal axis model, which, shaped like a capital "Y" and towed through the water by means of a rope connecting the lowermost end of the "Y" to the dial aboard the ship, shed itself of such unwanted debris. Curved metal plates on the outer arms thereof caused the unit to revolve about its central axis as it was drawn through the water. The curvatures of those plates were so adjusted that the speed of its revolution would be the same as on the vertical-axis model, namely one revolution for every ten feet of travel, so the same dial facilities could be used on both models.

At very low velocities, however, the rotor of the horizontal axis model would tend to sink lower and lower into the water—the slower the speed, the deeper it would sink. This tendency is represented by the several positions shown of the rotor in Figure 41c. The objection was that as the horizontal angle of the rotor increased, it tended to register lower velocities than it should. Under most conditions, however, this fault was not present. De Saumarez found various other practical uses for this equipment, such as to obtain data for a navigation chart showing the locations and magnitudes of the velocities occurring in the Eng-

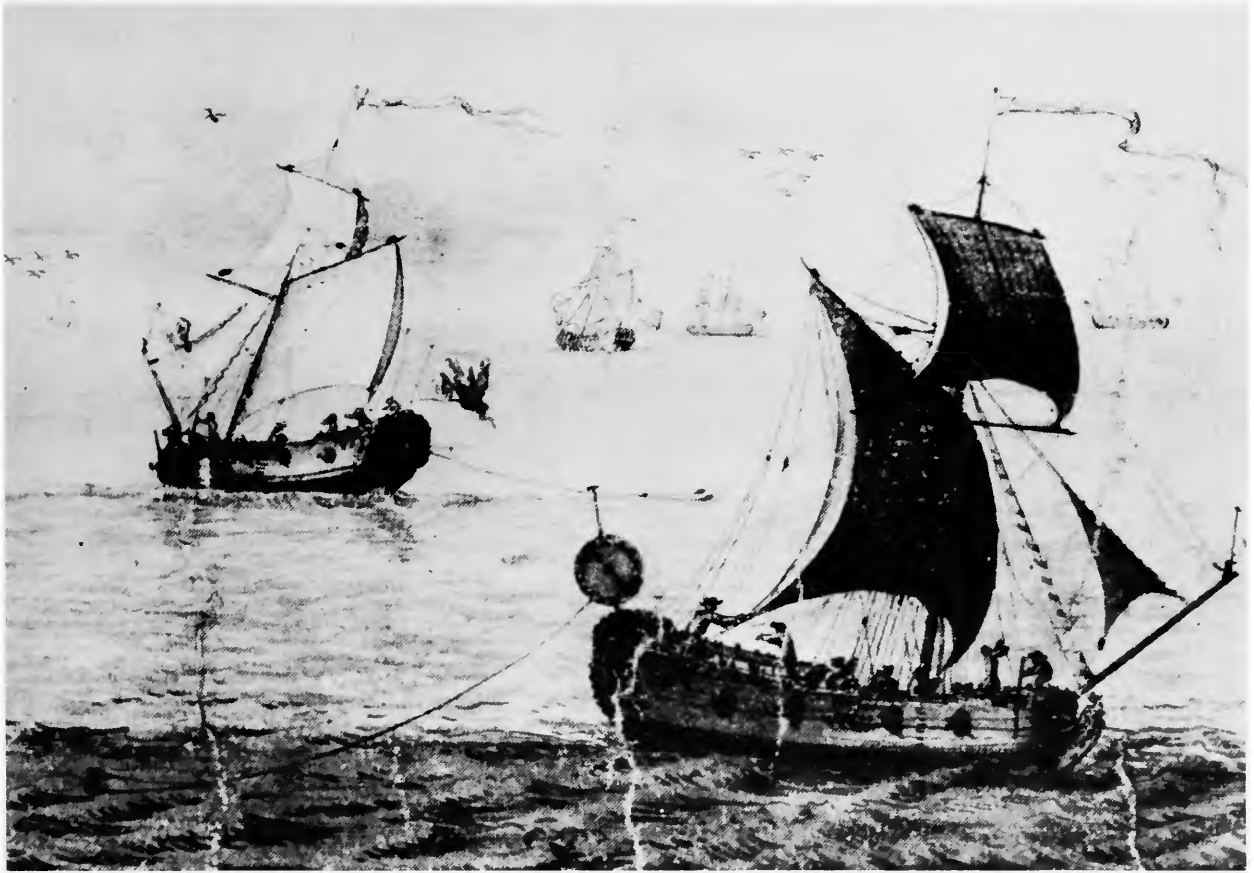

FIGURE 45.—A fleet of ships, ca. 1725, all equipped with De Saumarez' horizontal-axis ships' logs, purportedly gathering data on the currents in the English Channel. (Courtesy of the British National Maritime Museum.)

lish Channel. Such a chart, bearing the signature of its probable original owner, Captain Bligh of the *Bounty*, has been preserved in the British National Maritime Museum, Greenwich. At the top thereof is a painting showing a fleet of ships (Figure 45), all equipped with "Marine Surveyors," purportedly obtaining data for that purpose. A replica of the horizontal-axis rotor (Figure 46) is in the Smithsonian collection.

John Smeaton, the famous British engineer who built the noted Eddystone Lighthouse, had not yet been born at the time most of the above events were taking place. He studied, however, the De Saumarez' discussions of his ships' logs in the *Philosophical Transactions*,⁶⁰ and proposed what he thought would be a major improvement. His paper thereon was read before the Royal Society of London on 4 April 1754.⁶¹ His plan replaced the 27-inch-long Y-shaped rotor

and its stout cord, with a simple flat piece of brass, 10 inches long and 2½ inches wide, twisted into such a shape that it rotated in much the same manner as the original rotor. Because of its much smaller dimensions and weight and of the use of a much lighter and more slender cord, the drag forces and, consequently, the friction in the bearing that had to carry the load was greatly reduced—so much so in fact, that a different and much more efficient type of bearing could be used. Smeaton tested his apparatus in the serpentine river in Hyde Park, London, in much the same manner that De Saumarez had made his original tests. A replica of Smeaton's rotor is in the Smithsonian collection (Figure 47).

Apparently this idea did not prove to be as much of a success as Smeaton had hoped, because no mention of it can be found in later records.

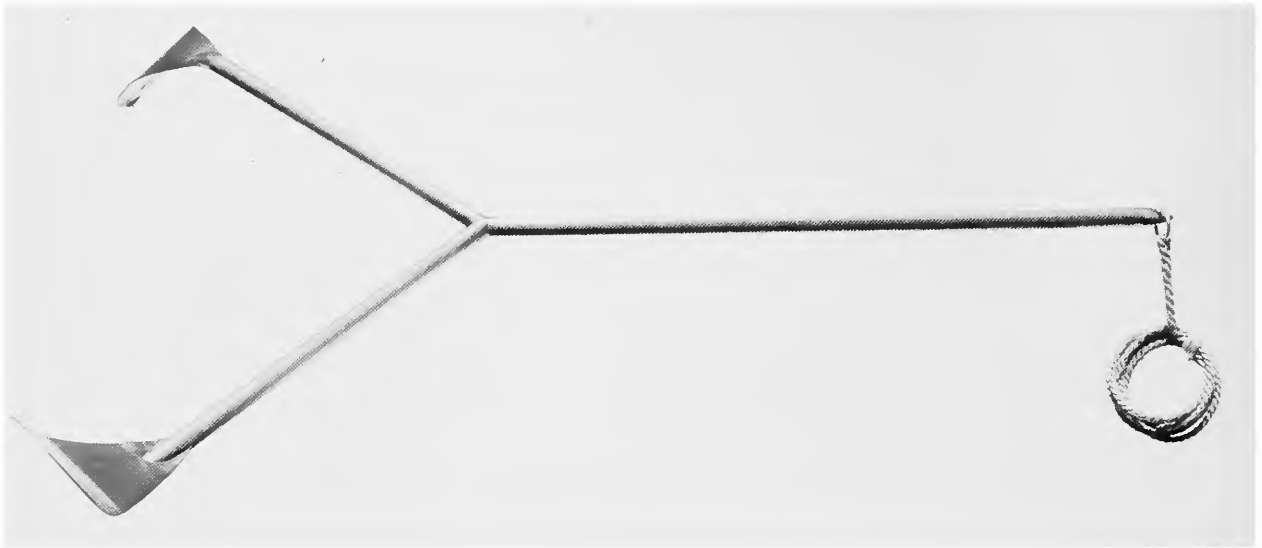

FIGURE 46.—Replica of the rotor used on De Saumarez' horizontal-axis ships' logs, ca. 1716. (NMHT 321480, photo by A. H. Frazier.)

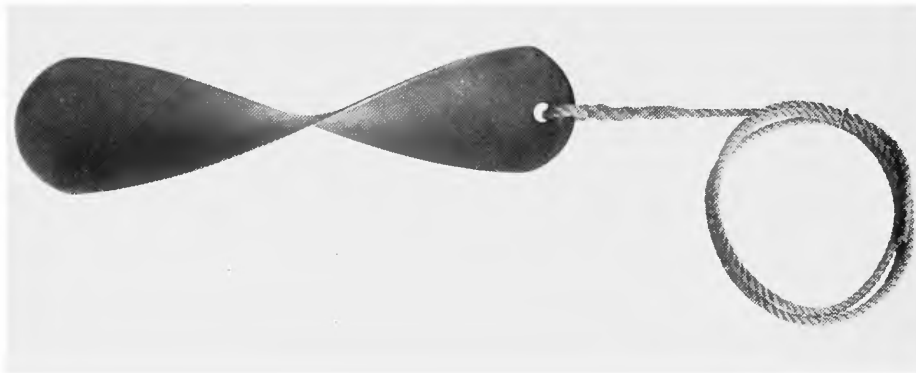

FIGURE 47.—Replica of the rotor John Smeaton proposed, ca. 1754, as an improvement over the Y-shaped De Saumarez model. (NMHT 321482, photo by A. H. Frazier.)

Administrative Strategy, 1716 Style

From what has been reported thus far about De Saumarez' ships' logs, it might be assumed that all of the problems he had experienced with them were of a mechanical nature. Those, however, which he encountered with the men concerned with "discovering the longitude" were much more frustrating. In 1717 he published a 17-page pamphlet setting forth his experiences with them.⁶² It revealed that his discovery had been offered to, and that he had been graciously received by, His Majesty, the King, but

that it had not been "so well encouraged by some of those appointed to examine and inquire into the same."⁶³ The King had suggested that he present his idea to the Royal Society of London for them to evaluate its merits. He accordingly visited Edmund Halley, of Halley's Comet fame, who was then Secretary of that society. Halley entertained him at his own house "in several friendly conferences" before De Saumarez presented his petition, but the Royal Society itself did not respond so cordially. It replied in effect that: (1) They did not conceive that the decision belonged to them; (2) it was not a new discovery;

and (3) the amount it would hinder the ships progress would not be compensated for by its anticipated advantages.

In December 1715, De Saumarez returned again to the King who, on this occasion, referred him to the Lords Commissioners of the Admiralty. They, as of 7 January 1716, referred his petition to Sir Isaac Newton, who was then President of the Royal Society. He, as of 27 January, submitted the following report to the Admiralty Office:

Sir,

According to the Order of the Lords Commissioners of the Admiralty, I have considered the inclosed Proposals of Mr. Henry de Saumarez, and discoursed with him upon the same, and am humbly of the opinion that by means of the Instrument he hath invented a Reckoning of the distance Sailed by a Ship may be kept with less trouble than by the Logg-Line, but I am not yet satisfied that the Reckoning will be so exact. The Instrument now proposed will keep a Reckoning of the Motion of the Ship with respect to the upper part of the Sea Water, but not of the driving of the Ship by Currents and Tides, and by the Motion of the upper Surface of the Sea caused by Winds, and how far it will keep a true Reckoning of the Motion of a Ship side Ways, occasioned by a side Wind, doth not appear to me, and therefore the Logg-Line is not to be laid aside . . . the Logg-Line alone should be depended upon, until it appears by Experience how far this New Instrument may be trusted. I have no Experience in Sea Affairs, nor ever was at Sea, and therefore my Opinion is not to be much Relied on.

[signed] Is. Newton

To quote De Saumarez: "The Lords of the Admiralty finding that Sir Isaac declined to give a decisive opinion they were pleased to put it into the hands of the Gentlemen of Trinity House."⁶⁵ After due consideration, that corporation prepared a list of objections to which De Saumarez responded on 14

April 1716. After considering that response, they sent a report to the Lords Commissioners of the Admiralty, dated 8 May, which stated bluntly that "the Corporation is of the opinion the same is wholly impracticable."⁶⁶

The Commissioners took no immediate action on that report. In fact, De Saumarez could not even get a copy of it, or information regarding its contents until 8 June. Then, upon finding what it contained, he attempted to obtain a patent on it, with the intention of building models at his own expense. He was told at the Patent Office, however, that no patent could be awarded thereon until the Lord Commissioners of the Admiralty submitted a report to the King, a procedure which they appeared reluctant to do.

On 5 July 1716, De Saumarez petitioned the Commissioners to report to the King in order that he, De Saumarez, would not be "hindered" from proceeding with the project on a personal basis. They thereupon forwarded immediately to the King the report they had received from Trinity House, stating that "we have nothing further to add thereto."⁶⁷

The concluding chapter of De Saumarez' pamphlet is headed: "Upon all which, the following observations are humbly offered." The chapter contains only five paragraphs, the most succinct of which states in effect that if he had been treated as promptly and respectfully by the gentlemen of the Trinity House as he had been by the Royal Society, he might in less than half an hour, have been saved a great deal of pains, loss of time, costs, and charges, and returned home where he "might have taken other measures." De Saumarez did indeed build several models and, as already explained, used them for studying the velocities in the Thames Estuary, and for charting those in the English Channel.

HORIZONTAL-AXIS METERS

Early European Developments

Robert Hooke

Robert Hooke (1635-1703), the author of *Hooke's Law of Elasticity*, and the first Curator of Experiments at the Royal Society of London, was a man of extraordinary talents. Several writers have ranked him second only to Leonardo da Vinci insofar as inventive ingenuity and conceptual creativity are concerned. Like Leonardo, one of the devices he conceived was intended for measuring the velocity of

flowing water. His model was considerably more sophisticated than Leonardo's in that it was provided with a velocity-sensing mechanical rotor, quite similar to those on modern current meters of the horizontal-axis type. He used rotors of that same type in at least three different applications: the current meter, a deep-sea sounding facility, and on a ship's log which he called "A Way-wiser for Sea" (Figure 48).⁶⁸ Figure 49 illustrates the rotor described in Figure 48 as the "Vane, Fly, or first mover of the whole."

*A Way-wiser For Sea.
November the 28th 1683.*

A WAY-WISER FOR SEA
November the 28th, 1683

*I shew'd an Instrument I had contriv'd
and shew'd some of the Society about 20
years since By which the way of a Ship
through the Sea might be exactly measured
as also the Velocity of any running Water
or River and thereby the comparative velocity
of it in its severall parts, by this also the quantity
of the water vented by any River into the Sea
or any other River might be found It was
one part of a way wiser for the Sea. The
whole Engine being designed to keep a true
Account not only of the Length of the Run of
the Ship through the water. but the true Rumb
or Leeward way, together with all the Jackings
and workings of the Ship This part of the Engine
now shewn was the Vane, Fly, or first Mover
of the whole, feeling as it were & distinguishing
the severall Qualifications of the Ships Course,
but was to be regulated by severall other
Additions in the compleat Engine which I
designe shortly to get executed.*

I shewed an instrument I had contrived
and shewed some of the Society about 20
years since by which the way of a ship
through the sea might be exactly measured
as also the velocity of any running Water
or River and thereby the comparative velocity
of it in its several parts, by this also the quantity
of the water vented by any River into the Sea
or any other River might be found. It was
one part of a way wiser for the Sea. The
whole Engine being designed to keep a true
Account not only of the Length of the Run of
the Ship through the water, but the true Rumb
or Leeward way, together with all the Jackings
and workings of the Ship. This part of the Engine
now shown was the Vane, Fly, or first Mover
of the whole, feeling as it were & distinguishing
the several Qualifications of the Ship's Course,
but was to be regulated by several other
Additions in the completed Engine which I
designe shortly to get executed.

FIGURE 48.—Hooke's report on a ship's log. (Photocopy from Register of the Royal Society of London, volume 6, pages 84-85; courtesy of the Royal Society of London; transcription by A. H. Frazier.)

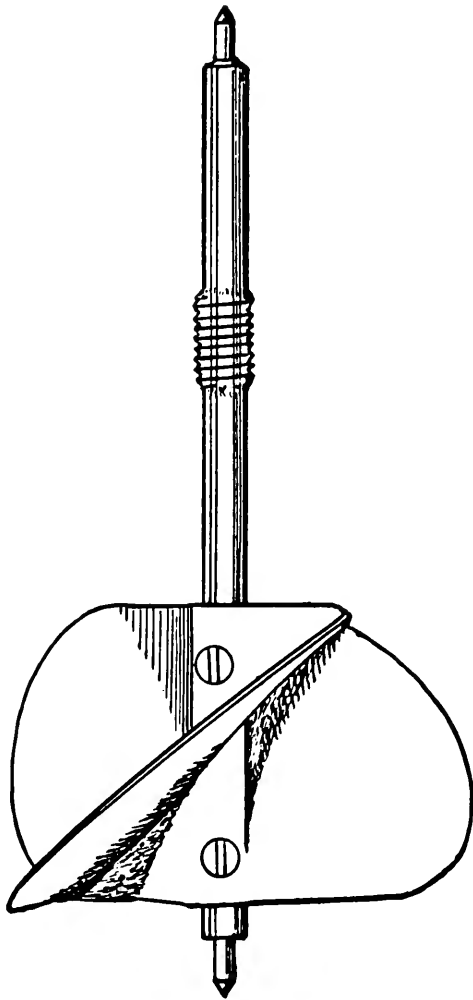

FIGURE 49.—Author's reconstruction of rotor that Robert Hooke used on his current meter, sounding device, and ship's log. (Drawn by A. H. Frazier.)

Although Hooke's current meter was not responsible for starting the present vogue for horizontal-axis meters, it represents the earliest of any devices of that type to have been found so far.

The second meter of the horizontal-axis type to have received any appreciable attention, was the one previously made by Henry De Saumarez. That too, failed to make any lasting impression or attract any appreciable number of followers.

Reinhard Woltman

Considerably more than a century after Robert

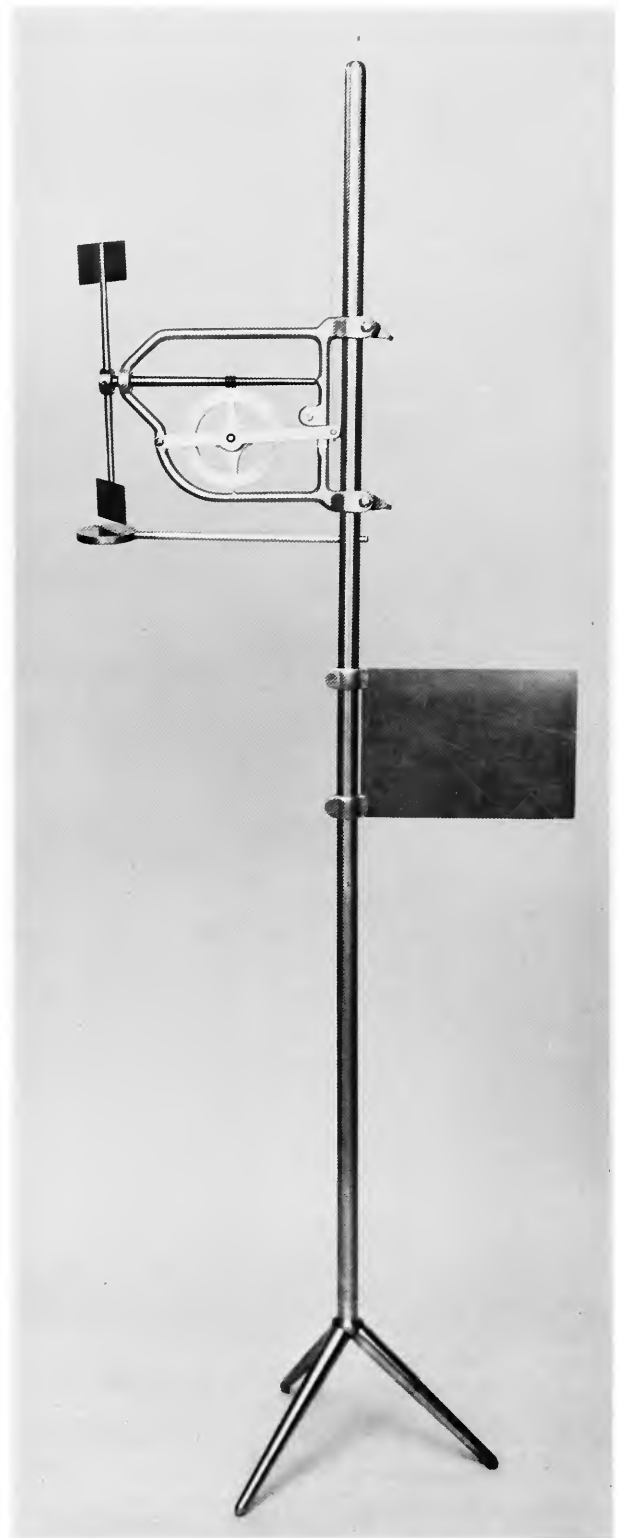

FIGURE 50.—Replica of the Woltman current meter, ca. 1790. (NMHT 317671, Smithsonian photo 72259.)

Hooke produced the first of the horizontal-axis-type current meters, Reinhard Woltman (1757-1837), who in 1784 was in charge of hydraulic operations at Cuxhaven, Germany, produced one that started the present vogue (particularly in Europe) of building current meters in that manner. It seems unlikely that Woltman had known about either the Hooke or the De Saumarez meters, but the principle of his rotor, and his use of a worm gear arrangement for counting the revolutions were very similar to those conceived by Hooke.

In 1790, Woltman published a booklet entitled *Theorie und Gebrauch des Hydrometrischen Flügels*, describing his new meter. It explains how he built an anemometer, after which he was faced with many problems about "rating" (i.e., calibrating) it. After several false starts, he finally rated it successfully in still water. This gave him the idea that by reducing the overall diameter of the rotor from about one meter to about one foot, the modified device would serve excellently as a water current meter. A replica of this water current meter (Figure 50) is presently in the Smithsonian collection.

Julien John Révy

Julien John Révy (fl. 1870), an Austrian by birth, but a resident of England in his later years, was a civil engineer of considerable importance. In 1857 he was the Director of the Martenson Machine Factory in England. Later he became a member of the Austrian Institute of Civil Engineers, and from 1869 to 1878 (probably the date of his death) he was a member of the British Association for the Advancement of Science. In that association's Annual Report for 1862 is a description of his bold plan for constructing a vehicular tunnel, lined with cast iron pipes, beneath the English Channel. His most important written work was his report on the *Hydraulics of Great Rivers: the Parana, the Uruguay, and the La Plata Estuary*. In it he describes how the discharges of those streams were measured under his supervision for the British Admiralty. In view of the fact that the La Plata Estuary alone is at its narrowest over twenty miles wide, this must have been the most ambitious stream gaging project of all time.

Many pages of Révy's book are devoted to the faults he found with the use of floats for measuring water velocities. Current meters, properly handled, he

claimed, could produce far more accurate results. Before leaving England to start work on that project, he had a current meter of his own design built. As his work in South America progressed, he kept alert for any changes by which it might be improved. His final design (arrived at after the project had been completed) became a regular stock item with the firm of Elliott Bros. (successors to Elliott & Sons) in London, and was listed along with Saxton's meter in several editions of their catalog.

American establishments that purchased at least one of the Révy meters were the United States Geological Survey, and the Coast and Geodetic Survey, both of which contributed their models to the Smithsonian Institution. A photograph of the one originally owned by the Geological Survey is shown in Figure 51. Among the innovations Révy introduced in his new current meter were the following:

1. The rotor was so designed that it would have no weight when submerged in water. The 2-inch ball at the center thereof was filled with air, and had just enough buoyancy to make the overall specific gravity of the rotor-and-shaft assembly equal to that of water. The purpose was to reduce the weight (and consequently the friction) on the bearings which supported those parts.

2. The compartment within which the counting gears were located, was filled with clean water, thereby preventing sand, grass, or other materials from becoming lodged between the gear teeth and slowing down the normal speed of the rotor.

3. Although Révy used a vertical bar to support the meter when using it in relatively shallow water, he suspended it from a long *horizontal* metal bar when making velocity measurements in deep water. On such occasions it was suspended from a surface vessel by means of two wires, one at each end of the vessel supporting the corresponding ends of the horizontal bar. (This method has come to be known as the "bi-filar" method of suspension.) The arrangement greatly reduced the tendency of the meter to swing like a pendulum when operating at great depths, and it provided better control of the apparatus while obtaining average velocities by the "integration" method.

The "integration" method consisted of lowering the meter slowly to the bottom, and then raising it to the surface at the same speed, with the counting gear engaged throughout the entire period of the "run," with the time required to make that run, carefully determined. The results thus obtained would be the

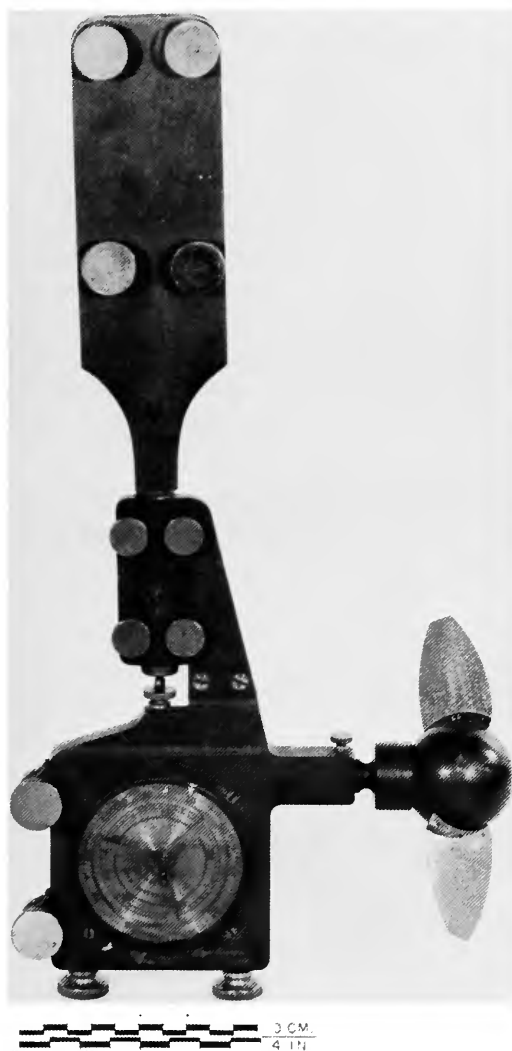

FIGURE 51.—The Révy current meter, manufactured by Elliott Bros., London, ca. 1874. (NMHT 289646, Smithsonian photo 44538-C.)

average, or *integrated* velocity throughout the vertical at that point in the stream. It was, as a matter of fact, the only method that could be applied with a “bi-filar” suspension system, because it was not possible to manipulate a third wire or cord properly for engaging or disengaging the counting gear on the meter. Point observations could only be obtained with this meter when it was suspended from a vertical rod or bar, but the maximum depth at which such a bar could be handled even when the velocities were moderate was quite limited.

Révy’s current meters—in fact all current meters having a similarly geared counting arrangement—were eclipsed in popularity with the advent of Henry’s electrical contact facility, which, as will be described, reduced the amount of friction in meters, eliminated the need for the operator to raise the meter to where he could make “before” and “after” readings of the dial for each run, and allowed either “point” or “integrated” observations at any depth without any loss of time or any changes in his equipment.

Joseph Saxton

Joseph Saxton (1799-1873) the first and most outstanding American to invent a current meter, has in the past received perhaps the least attention of any such inventors. The story of his life would have been a fitting subject for Horatio Alger. He was a descendent of George Saxton who came to America in about 1663 and lived first near Windsor, Connecticut, and then at Westfield, Massachusetts. Subsequent members of his family line lived successively at Huntington, Long Island; Hopewell, New Jersey; Frederick, Maryland; and finally, at Huntingdon, Pennsylvania, where Joseph was born 22 March 1799. His grandmother was Sarah Harlan of the same family of Harlans from which the two Justices of the United States Supreme Court descended, and his brother John was the founder of the still-active newspaper, *Akron (Ohio) Repository*, and the grandfather of Ida Saxton McKinley, wife of the martyred President.

Joseph left school at the age of twelve to begin working at his father’s nail factory. That work soon lost its appeal, and he was apprenticed to a local watch-maker. During that apprenticeship, he learned the importance of precision workmanship, and the subject fascinated him. To constantly improve his talent in that field became a primary goal of his career. Upon the death of his employer, the nineteen-year-old Joseph left Huntingdon for Philadelphia. That city, then the science center of America, seemed to offer further opportunities for achieving his goal.

In 1824, the Franklin Institute in Philadelphia was established, and Joseph was among its early members. During that same year, the Institute held its first public exhibition. Prizes were offered for many classes of entries, and one of the local clock dealers entered a clock into that competition which Saxton had built

for him. The clock was unusual in two special respects: the pallets on its escapement did not have to be kept oiled, and it had a unique type of temperature-compensated pendulum. Saxton received the highest award offered for such an entry, a silver medal.⁶⁹

One of the persons who judged that contest was Isaiah Lukens, one of Philadelphia's finest mechanics, a vice president of the Institute, and perhaps the leading manufacturer of tower clocks in the Philadelphia area. He took Saxton into his shop as an associate, and within the next four years they built one of the three tower clocks that has occupied Philadelphia's historic Independence Hall.

In about 1829, Saxton, still searching for oppor-

tunities to improve the precision aspects of his work, left Philadelphia for a seven-year sojourn in London. Just as Philadelphia was the *American Mecca* for those who wished to develop their scientific talents, London had become the *world Mecca* in that respect. A possible additional inducement that led Saxton to make the trip was the imminent completion there of a new museum officially called the "Gallery for the Illustration and Encouragement of Practical Science" (later abbreviated to the "Adelaide Gallery" because of its location at No. 7 Adelaide Street in the Strand). Contemporary observers described that gallery as both large and elegant—perhaps the most elegant in the metropolis (Figure 52). The Gallery had originally been intended to serve as a showplace for exhibiting

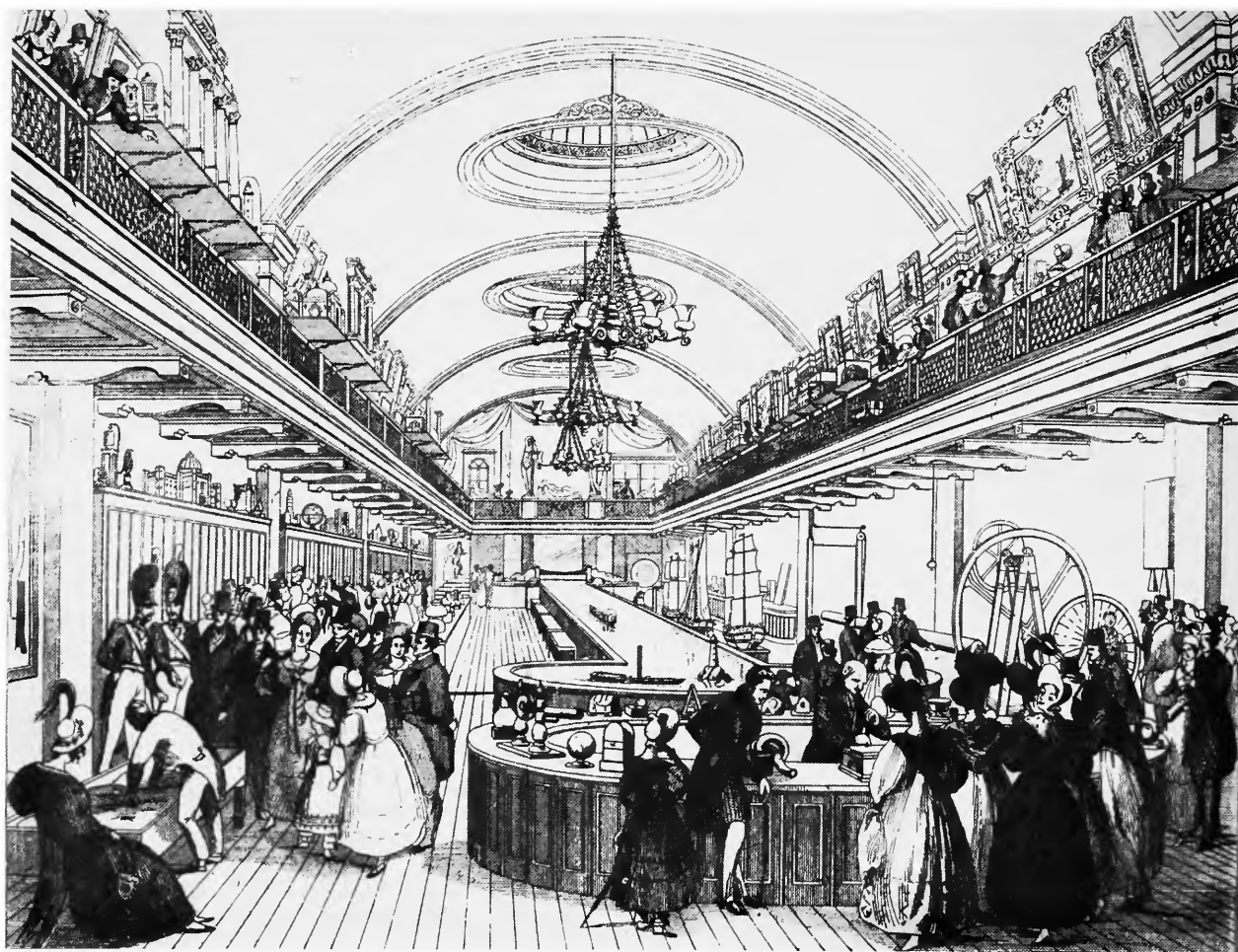

FIGURE 52.—The "Long Room" of the Adelaide Gallery in London. In 1832, Saxton rated his current meter in the 70-foot-long tank of water shown in this room. (From the catalog of the Adelaide Gallery, May 1836.)

the steam boilers and other inventions of Jacob Perkins (1766-1849), an ingenious Philadelphian who, before moving to London in 1819, had been a manufacturer of fire engines with Coleman Sellers, one of Saxton's close friends.

Whether Saxton had been assured in advance that he would receive work building permanent exhibits for that new gallery is not known, but it is well established that promptly after his arrival, he received orders to build several of such exhibits. The work was performed at his newly established shop at 22 Sussex (now Huntley) Street, one block east of Gower, near the University College. After the Gallery opened on 4 June 1832 he gave lectures there concerning those and other exhibits.

During the mid-1830s, while Saxton was still at London, Franklin Peale, acting in behalf of the United States Mint, placed an order with him to build an assay balance. That balance turned out so well that several more balances were ordered, and R. M. Patterson, then Director of the Philadelphia Mint offered him "a good job to begin with" if he would return to America and perform work for the Mint. Saxton accordingly returned to Philadelphia in 1837, and worked for the Mint until 1843, when A. D. Bache, then Superintendent of the United States Coast Survey, induced him to move to Washington, D.C., and assume charge of the Office of Weights and Measures, the forerunner of the National Bureau of Standards. While holding that position, Saxton finished building and delivering to those States not supplied, a complete set of volumetric, lineal, and weight standards, together with a set of balance scales (one large, one medium, and one small) for use with those standard weights. It would seem that in building those precision standards for most of the States, Saxton's goal in life had finally been achieved. He continued in that position until his death, 26 October 1873.

Among the many honors Saxton had received during the course of his lifetime, were those of being selected a charter member of the National Academy of Sciences, and a member of the American Philosophical Society. One of the "State" balances he had constructed was sent to the Great Exhibition in London in 1851, for which he was awarded a gold medal.

Saxton's first efforts in developing current meters came as a result of a purchase order from Joseph Cubitt—son of the prominent civil engineer William Cubitt (1785-1861)—while Saxton was working at the

Adelaide Gallery in London. Saxton mentions some of the subsequent work on the meter in a diary, which is preserved in the Smithsonian Archives:⁷⁰

May 25, 1832. Saw J. Cubitt and Mr. Cooper [at the Royal Institution] who introduced me to Mr. Faraday.

August 2, 1832. At work at a current meter for Cubitt.

August 11, 1832. Went to 7 Adelaide Street. Made experiment with the current meter.

August 21, 1832 7 Adelaide Street. Saw there J. Cubitt and his sisters.

August 23, 1832. At 22 Sussex Street. Finished current meter for Cubitt.

When, in 1836, the gallery published its first issue of *The Magazine of Popular Science*, it contained an illustrated article entitled: "Description of the Current Meter as Recently Improved by Mr. Saxton." A reproduction of those illustrations appears in Figure 53. As may be seen in that figure, the rotor on this meter consisted of a flat piece of brass twisted into such a shape as to cause it to revolve when water moved through it. Whenever the "engaging" cord was held taut, the rotating shaft would cause the counting wheel to start operating. Saxton "rated" his current meter in the 70-foot-long water tank in the Long Room of the Adelaide Gallery (Figure 52). The rating consisted of increasing or decreasing the amount of twist in the rotor until it would make exactly one revolution for every foot the meter traveled through the still water in that long tank.

In this connection it should perhaps be mentioned that Saxton, Charles Wheatstone (famed for the "Wheatstone Bridge" for making electrical measurements), together with a John Martin and two other persons, made a measurement of the flow of the Colne River at Denham Point near London with Saxton's current meter on 22 June 1834, in accordance with a plan proposed by Martin for improving London's water supply.⁷¹

During the 1830s there existed in London a firm by the name of Watkins and Hill that sold scientific instruments and laboratory equipment. After Saxton arrived in London, their catalogs listed several articles that Saxton had designed and furnished to them. Saxton's current meter, however, does not appear in any of their few surviving catalogs. Nevertheless when that firm was taken over by the Elliott organization in the 1850s, it was listed in the catalog that showed the combined products of the two firms. An illustration of the meter also appeared in 1858 as "Fig. 129A" in the first edition of W. Davis Haskoll's book entitled *The Practice of Engineering Field*

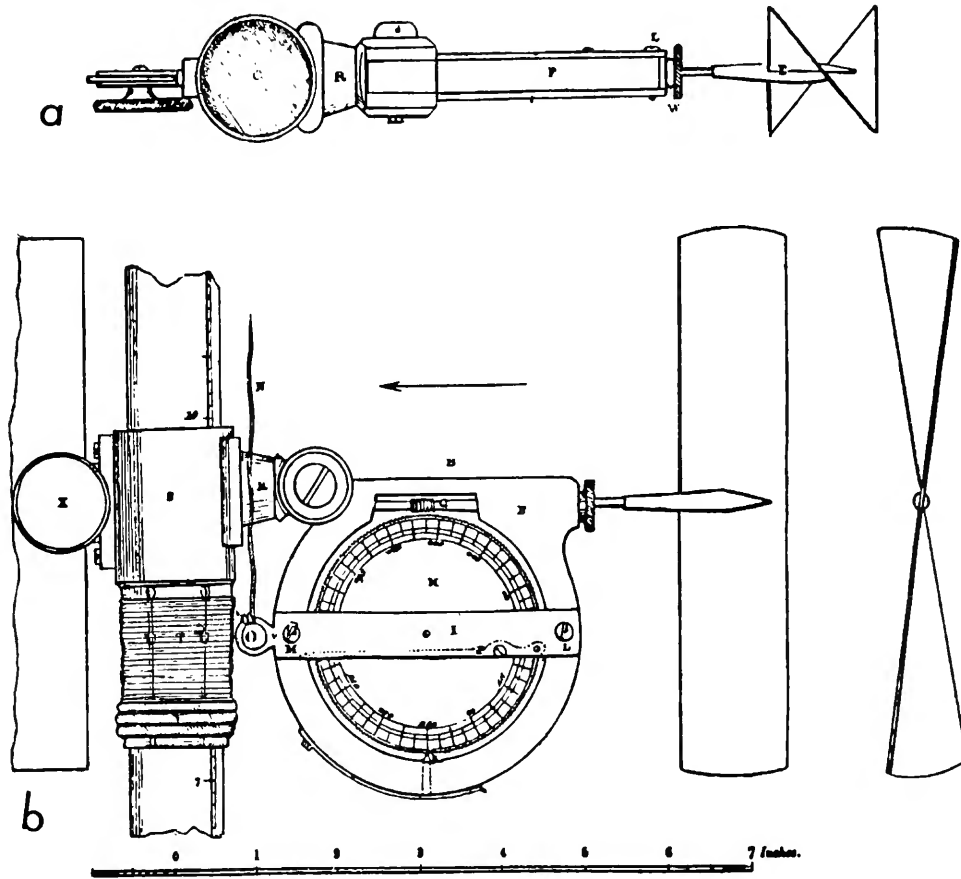

FIGURE 53.—Joseph Saxton's water current meter: *a*, top view; *b*, side and end views.
(From Adelaide Gallery, "Description of the Current Meter.")

Work, together with the following statement: "Elliott's [i.e., Saxton's] Current Meter is a most useful instrument for ascertaining velocities, either a few inches below the surface, at the bottom, or at any depth between."⁷²

In any event, the Proprietors of Locks and Canals of Lowell, Massachusetts, were among those who acquired one of Elliott's models of the Saxton meters, and in 1956 they contributed it to the Smithsonian Institution (Figure 54).

Although Saxton's meter was never listed in any American manufacturer's catalog, quite a number of them were custom-built here, and they made appearances in several unexpected places. One such appearance is mentioned in the Humphreys and Abbot famous *Report Upon the Physics and Hydraulics of the Mississippi River*.⁷³ Saxton's was the only current meter used in that study, whereas over 99 percent of the other observations were made with floats. On an-

other occasion, Professor William P. Trowbridge of the U.S. Coast Survey⁷⁴ attached two Saxton current meters (both pointing downward) onto a device he had invented in 1857 for sounding the depths of the ocean in places too deep to be reached with the conventional line and weight. Their function was to measure the depth as the device descended to the bottom. Upon arriving there, a detent locked their motion, so that upon raising the assembly, the operator could observe on the counting wheels the number of rotations made by their rotors and thereby compute the ocean's depth.

Prior to the Civil War, Humphreys, Trowbridge, and Saxton were fellow employees in the U.S. Coast Survey, and were well acquainted. There seems little doubt but that all of these meters were built in the instrument shop of the Office of Weights and Measures, where the lineal, volumetric, and weight standards had been built under Saxton's supervision for

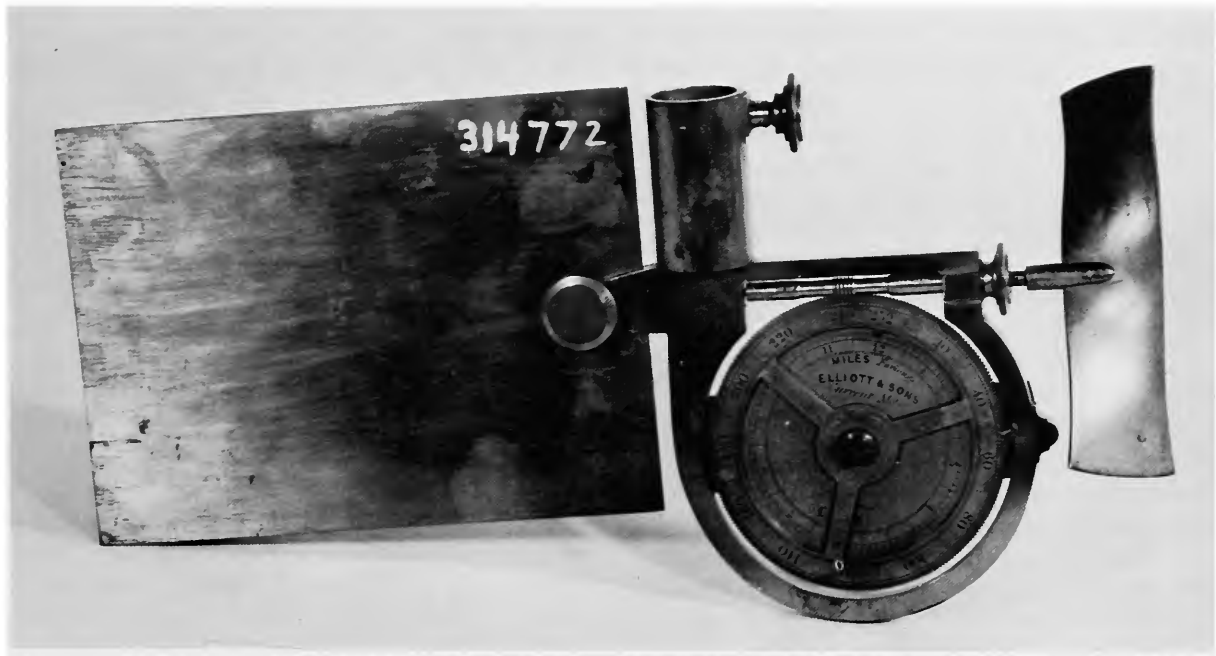

FIGURE 54.—Saxton's current meter as manufactured by Elliott & Sons, London.
(NMHT 314772, Smithsonian photo 44536-A.)

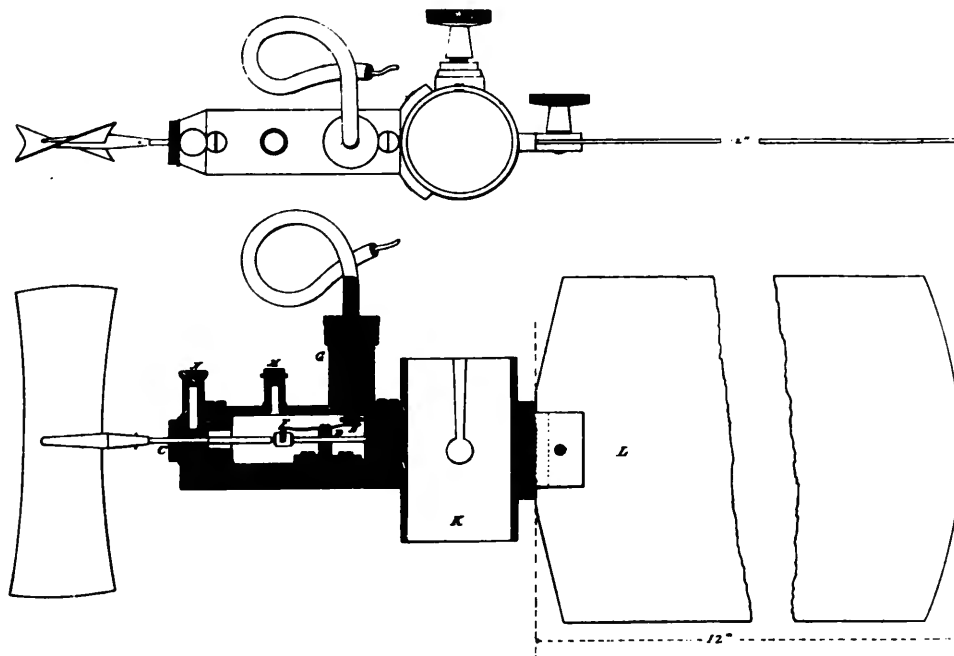

FIGURE 55.—The "Abbot" meter. (From Payson, "Current-Observations in San Francisco Harbor, California.")

the American States.

Perhaps the most unexpected circumstances under which Saxton current meters were used occurred in 1877 and 1878 when the federal government made a study of the hydraulic aspects of San Francisco Bay.⁷⁵ In his report on that study, Lt. A. H. Payson called them "Abbot" current meters. General Henry Larcom Abbot had provided them for use on that study after having redesigned certain parts to overcome the problems caused by using them in sea water. A drawing of one of these meters, as it appears in Payson's report, is shown in Figure 55.

Current meters were not accepted without controversy, even by those who were the forerunners in hydraulic engineering. In Humphreys' and Abbot's report on the Mississippi River, it had been stated that double floats were superior to any other device for measuring water velocities.⁷⁶ In 1868, when Daniel Farrand Henry of the U.S. Lake Survey ventured to invent and use current meters for measuring the outflow of the Great Lakes, both Henry and his superior, General William F. Raynolds were severely disciplined for having used meters for that purpose.⁷⁷ Henry Abbott, the co-author of Humphreys' Mississippi River report, expressed himself as follows in a subsequent report: "In my opinion, . . . instruments of this class are pretty toys, which have contributed more to retard the progress of discovery in the science of river hydraulics than any other one cause,"⁷⁸ and for many years thereafter, Abbot and Henry debated this subject bitterly.

One of the major improvements Henry had made on current meters was the electrical facility for counting the revolutions made by the rotor. After having first installed such facilities on his Saxton current meter, and finding them to work successfully, he next applied them to the cup-type meters of his own invention, the latter of which received favorable attention in several European technical magazines.

In view of Abbot's opposition to the use of any current meters, the advent of the "Abbot" meter at San Francisco ten years after his objections were published, must have surprised many of those familiar with the acrimonious Abbot-Henry debates. Moreover, Abbot's meter consisted essentially of a Saxton meter furnished with an electrical contact, just as Henry had originally changed it. The only difference was that Abbot had enclosed the contact facilities within an oil-filled brass compartment intended to exclude the salt water from the area where the con-

tacts took place.

If Abbot ever felt that his action represented any softening of his attitude toward Henry's work, he never admitted it publicly.

The Baumgarten Meter

Table I in Professor Kolupaila's *Bibliography of Hydrometry* is a list of "Significant Hydrometric Measurements in the 19th Century." The third entry refers to measurements obtained of the Tiber River in Italy by Giuseppi Venturoli (1784-1846) starting in 1821, and the seventh entry refers to those obtained of the Garonne River in southern France by André Gustave Adolphe Baumgarten (1808-1856) starting in 1838. Venturoli was a professor of mathematics at the University of Bologna, and Baumgarten was an engineer at the Ponts et Chaussées in Paris. In both Venturoli's book, *Elementi di Meccanica e Idraulica*, and Baumgarten's article, "Sur le moulinet de Woltmann . . .,"⁷⁹ the same type of current meter is illustrated (Figure 56a, b). Venturoli did not identify the person who designed that meter, but Baumgarten made a special point of crediting Woltman. It was, in fact, an improvement over the original Woltman meter (cf. Figures 50 and 56), and Woltman probably had nothing to do with the changes that had been made. That generous gesture, however, has resulted in numerous subsequent writers of modern hydraulic text books maintaining the same designation for this type of meter, i.e., Woltman meter, whenever they used Baumgarten's illustration.

In any event, unless Venturoli himself conceived this improved model, the name of the person responsible for it has not received the credit due him. By 1847, this meter became a regularly manufactured product of the firm of Lerebours et Secretan of Paris. Copies of several of their catalogs illustrating it among their hydraulic instruments still exist. The Proprietors of Locks and Canals at Lowell, Massachusetts, purchased from them a meter of this type, which in 1956 they contributed to the Smithsonian Institution (Figure 56c).

This meter was just the first of two with which Baumgarten had become concerned. While using it, he realized that the relatively small pallets (or vanes) on this meter could utilize only a small portion of the total driving force present within the circle defined by their rotation; if the total force available within that

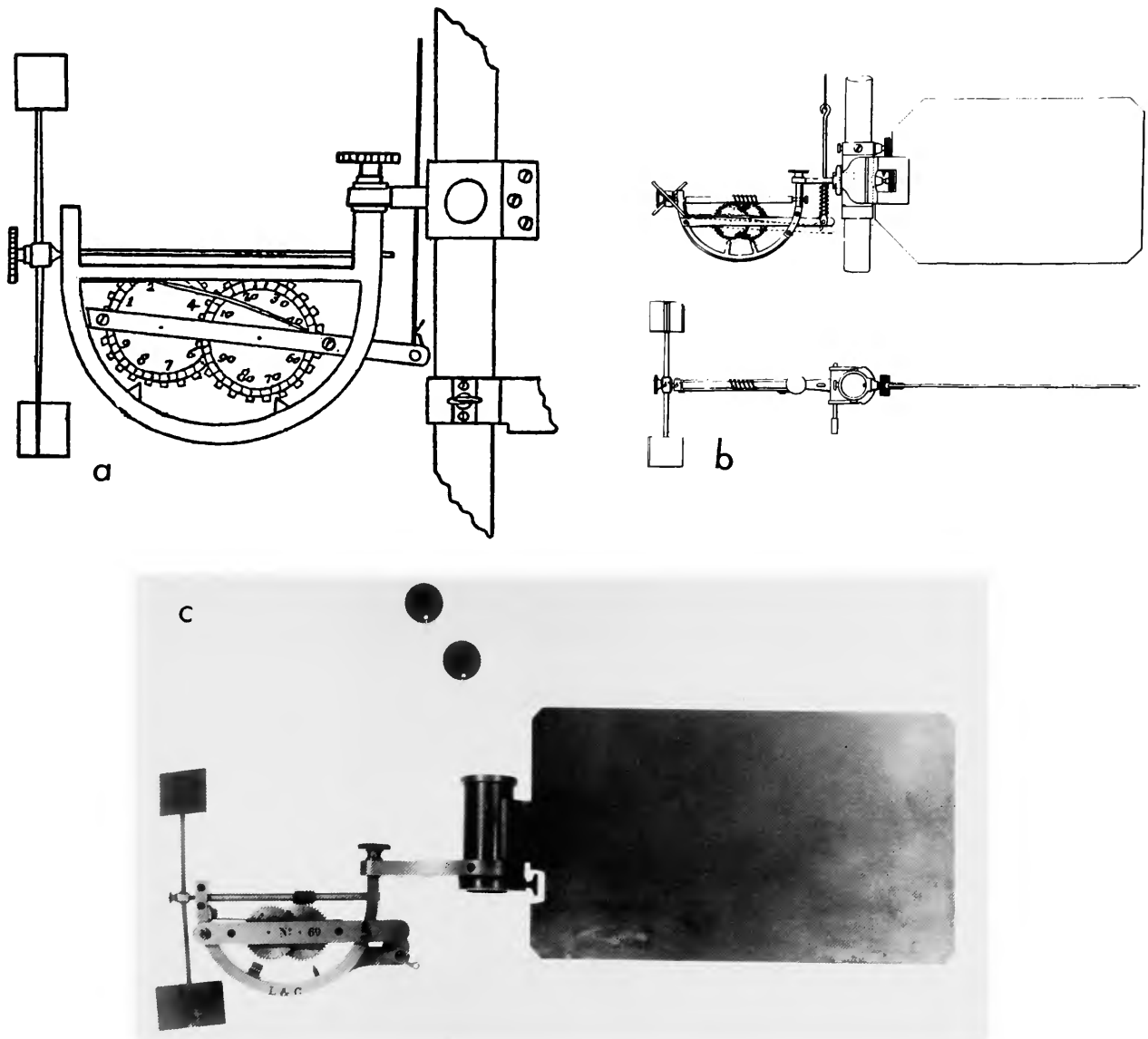

FIGURE 56.—Woltman current meters: *a*, Venturoli's version, 1818; *b*, Baumgarten's drawing, 1847; *c*, improved model manufactured by Lerebours et Secretan, Paris. (*a*, Redrawn by A. H. Frazier after Venturoli, *Elementi di Meccanica e Idraulica*; *b*, from Baumgarten, "Sur le moulinet de Woltmann"; *c*, NMHT 314769, Smithsonian photo 73-777.)

circle were made use of, the driving force would be much enhanced. In fact, a rotor of much smaller overall dimensions probably could be used without any sacrifice of power. He accordingly suggested that change to his supervisor, Jean Victor Poncelet (member of the French Academy of Sciences), who assigned a Paris instrument-maker named Conte to work with Baumgarten to produce a new meter with at least two rotors of the suggested type. Each rotor was to have

four helicoidal blades surrounded by a wide metal band for strengthening the assembly. Each blade extended to the axle, and occupied one-fourth of the projected area within the ring. The rotors differed however, in that they had pitches of 0.08 and 0.12 meters, respectively. Either could be installed on the same meter, so that their performances could be compared under identical operating circumstances. The meter was completed late in 1846. During the months



FIGURE 57.—Baumgarten's current meter, manufactured by Secretan of Paris, ca. 1846.
(NMHT 314773, Smithsonian photo 44536.)

that followed, Baumgarten performed his tests on it while conducting his studies on the Garonne River. Illustrations of it appeared in Secretan's catalog (successors to Lerebours et Secretan—Marc Lerebours having died in 1867) for numerous years. Baumgarten died a suicide in 1859.

Two of the 1846 models were to contribute to hydraulic history in America. The Proprietors of Locks and Canals of Lowell purchased one of them (Figure 57), and Clemens Herschel, the noted hydraulic engineer who often did work for those Proprietors, purchased the other.

In the early 1870s, two major hydraulic projects were being undertaken in the northeastern United States. General Theodore Grenville Ellis (1829-1883), a member of the Corps of Engineers, U.S. Army, under the Chief of Engineers, A. A. Humphreys, had been placed in charge of a study aimed at improving the Connecticut River for navigation, and Alphonse Fteley (1837-1903) had been named the resident engineer in charge of the construction of the new water supply for Boston from the Sudbury River. Baumgarten current meters served a useful purpose on both of those projects.

In about 1870, when General Ellis began his work on the Connecticut, he purchased the Baumgarten current meter from Clemens Herschel. In view of General Humphrey's strong opposition to the use of such instruments, it seems likely that any publicity regarding its purchase would have been kept to a min-

imum. In fact, when Ellis wrote his official report on the project, and had to admit having made use of such a current meter, he spent several pages explaining his reasons for having done so.⁸⁰ His arguments were so convincing that Humphrey credited him with having used good judgment, and the ban against the Army's use of current meters was thereupon lifted.

Before Ellis could make any use of the Baumgarten current meter, it had to be rated to establish an equation showing the relationship between the number of feet per second (f), at which the water was flowing, and the number of revolutions per second (n), performed by the rotor. Ellis made one such rating in 1870, and another in 1874, and found that for velocities between 0.7 and 9.0 feet per second that equation was: $f = 5/12 n + 0.25$. On the same occasions, however, he learned that the meter "ceased to register accurately and in exact conformity with the formula below 0.7 feet per second."⁸¹

Ellis made considerable use of this meter during the first four years of his work on the Connecticut River, but its lack of precision in the lower velocity range, caused him to explore other possibilities. By June 1874 he had designed a vertical-axis cup-type current meter similar (but smaller) to that designed several years earlier by Daniel Farrand Henry of the U.S. Lake Survey. The new "Ellis" meter was so superior to Baumgarten's model that he performed the remaining measurements of his project with the new one.

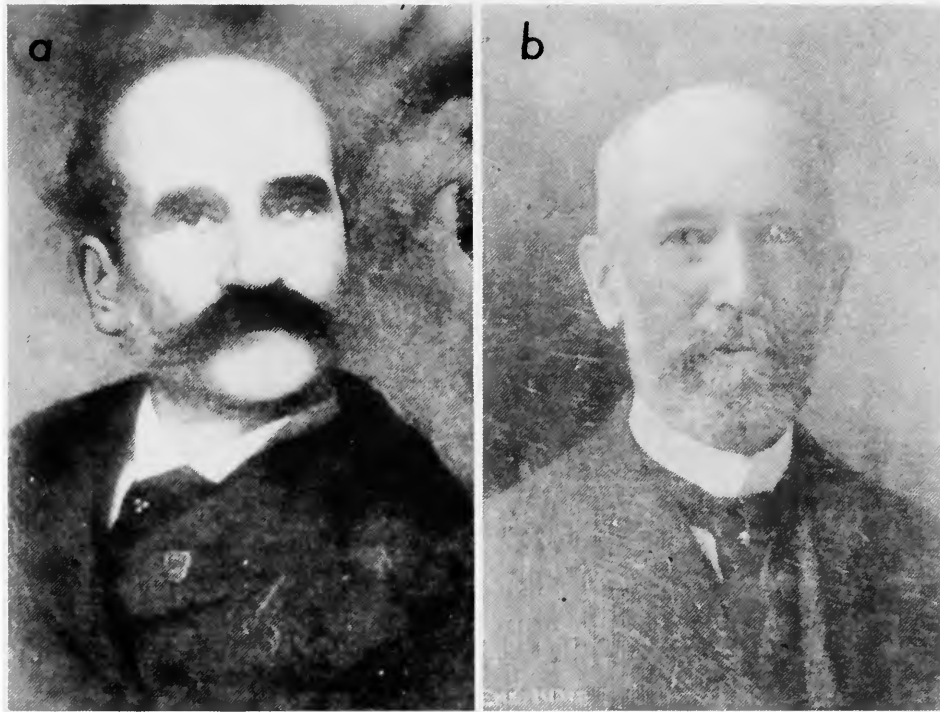

FIGURE 58.—The principle hydraulic engineers who constructed the Sudbury River water-supply system for Boston and designed many other outstanding hydraulic projects in America: *a*, Alphonse Fteley; *b*, Frederick Pike Stearns.

The “Ellis” meter will be discussed shortly. The point to be observed here is that the Baumgarten meter played an important part in overcoming the Corps of Engineer’s prejudice against the use of current meters, and it contributed to the development of Ellis’ considerably better instrument here in America.

Work on the Boston water-supply project began in 1873, just a short while before Ellis stopped using the Baumgarten meter. Alphonse Fteley (Figure 58*a*), who was the resident engineer in charge of the project, soon found that he too needed a current meter. The need was met by borrowing the Baumgarten meter from Ellis, and having a local instrument manufacturer, Buff and Berger, make a copy of it (Figure 63*a*). The new model differed from the original in two respects: its rotor was slightly larger in diameter, with more blades having a longer pitch; and the facility for disengaging the counting wheels was reversed in that the spring that formerly kept those wheels disengaged (until activated by a pull on the operating cord) now kept them engaged during the periods of operation. It had been noted while in Ellis’ possession, that the force applied to the cord was

sometimes great enough to damage the gears. Such an effect could not take place if the spring were used to keep those gears in mesh, and the cord used only for disengaging them. A drawing of that new current meter (Figure 63*a*) appeared in an article by Frederick P. Stearns, Fteley’s principal assistant (Figure 58*b*).

Fteley and his assistants used this meter for several years for measuring the flow of the Sudbury River and nearby streams. He also found it satisfactory in most respects, except for measuring low velocities. Like General Ellis, he thereupon developed a new meter.

About the only part of the new meter which resembled any part of Baumgarten’s was the rotor, and even that was modified. It had several more vanes, all with a longer pitch. The axle extended completely through the rotor, and was supported by both front and rear bearings. The counting wheels were smaller in diameter, and arranged to face upward, so that the operator could read them without lifting the meter completely out of the water. The first models of this meter were manufactured by Buff and Berger.

It should be noted that the Fteley meter (often referred to as the "Fteley-Stearns Meter" because Stearns assisted in its development) was of a special-purpose type. Its major purpose was to measure, through a manhole, the velocities occurring in underground conduits which had been built for conducting water from the Sudbury River to Boston. It was always suspended from a rod. The operator could therefore easily maintain its proper orientation which eliminated the need for a tailpiece. While that feature admirably served the need on this water-supply project, it restricted the use of the meter to relatively shallow streams and conduits where cable-suspension facilities (and tailpieces) were not essential.

Practically no changes were made in the design of the Fteley-Stearns meters for over 25 years. In 1911, however, while still an Assistant Engineer of the Proprietors of Locks and Canals at Lowell, Massachusetts, Arthur T. Safford (1867-1951) proposed changing the design of that meter by decreasing the number of vanes thereon from 8 to 6, increasing the diameter of the rotor from $3\frac{1}{2}$ to 5 inches, and making the frame larger and somewhat stronger.

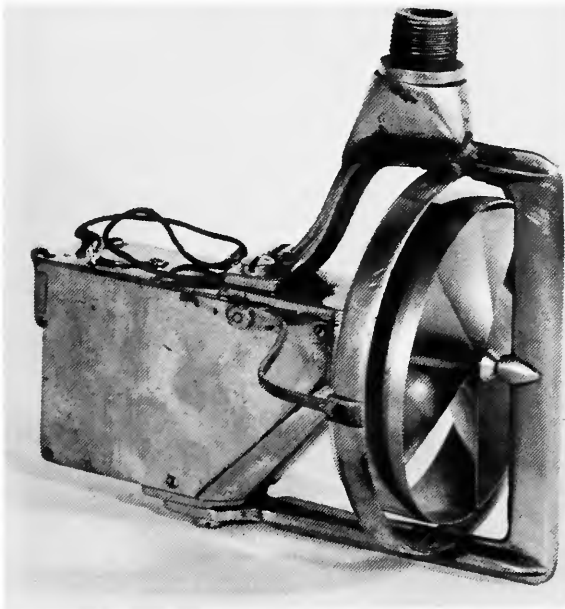

FIGURE 59.—A current meter contributed to the Smithsonian Institution by the Proprietors of Locks and Canals of Lowell, Massachusetts, which may be an experimental model designed by A. T. Safford. (NMHT 314771, Smithsonian photo 44536-C.)

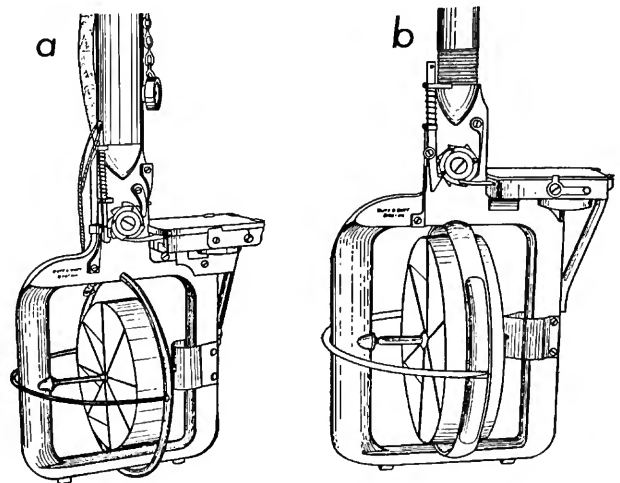

FIGURE 60.—Comparison of the original (a) and improved (b) Fteley-Stearns current meters as presented by Hughes and Safford, *A Treatise on Hydraulics*, 1916.

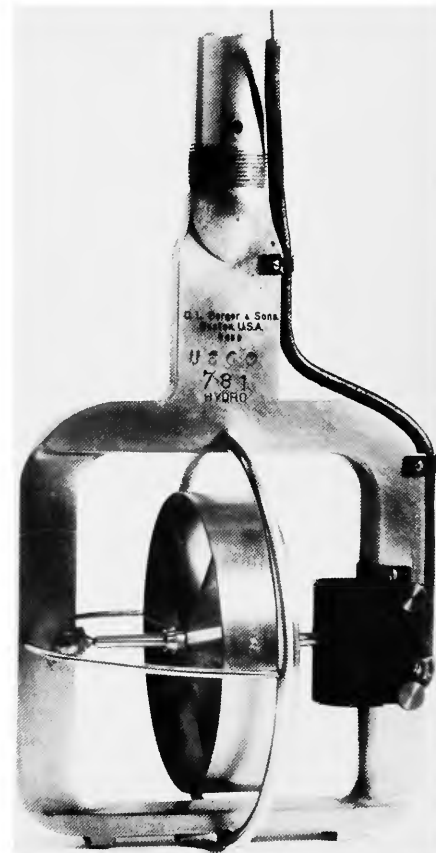

FIGURE 61.—A Fteley-Stearns current meter manufactured by C. L. Berger & Sons, Boston. (NMHT 330410, Smithsonian photo 75409.)

Although its record is not entirely clear, there is in the Smithsonian collection, a current meter (Figure 59) that came from the Proprietors of Locks and Canals, which has about the same type of rotor that Safford had advocated. Its counting gears, however, are located in a rather bulky metal box behind the rotor with a glass window at one side for observing the readings. Since no other current meters like it are known to exist, this might well have been an experimental model which Safford had designed while developing the "improved" instrument. The final model was provided with a much smaller counting wheel box, which faced upward and was located in a far more convenient location. Figure 60 shows a comparison between the old Fteley-Stearns and the new Safford models.

In later models, the counting wheels were eliminated entirely in favor of the electrical contact method as conceived by Daniel Farrand Henry. While all this had been taking place, the firm that had constructed the original Fteley-Stearns meter, Buff and Berger, had dissolved its partnership, and both members thereof set up separate businesses, but both of those separate firms continued manufacturing all of the

models in which Fteley, Stearns, and Safford were involved. One of those later models, as manufactured by C. L. Berger & Sons, was eventually added to the Smithsonian collection (Figure 61).

From all these events it is apparent that the Baumgarten current meter that Clemens Herschel sold to General Ellis produced a truly notable impact on the design of such instruments in America. This, however, does not mark the end of the saga. The story of the meter shown in Figure 57—the one that the Proprietors of Locks and Canals purchased at the same time that Herschel obtained his—also deserves attention.

James Francis, who at that time was the Chief Engineer of Locks and Canals of Lowell, Massachusetts, was favorably impressed with the Baumgarten current meter although he too recognized as a deficiency its failure to operate satisfactorily at low water velocities. In the belief that much of that deficiency could be remedied by improvements in the bearings, he requested Herschel to take the matter up with George Louis Buff (1839-1923), the senior member of the Buff and Berger firm in Boston, to see what he thought could be accomplished in that respect. Buff was born in the university city of Geissen, Germany,



FIGURE 62.—Three experimental rotors manufactured by Buff and Berger, Boston, ca. 1876, for trial on the new "Herschel" meter, an American version of the Baumgarten meter (NMHT 314766, 314767, 314768; Smithsonian photo 44536-B.)

and was of the old German school of fine instrument makers.

A transcription of the first letter, dated 20 September 1876, that Herschel wrote to Francis on this subject and which had been preserved in the Office of the Proprietors of Lock and Canals, follows:

To James B. Francis
Civil Engineer,
Agt. Props. Locks & Canals
Lowell, Massachusetts.

From Office of Clemens Herschel
Civil and Hydraulic Engineer,
66 State Street, Boston,
Sept. 20, 1876.

Dear Sir:

I have not exactly got Mr. Buff started on making your new current meter, but am gradually starting him. My idea is to make the instrument of certain defined dimensions & mathematical shapes or forms throughout, so that from its description, another just like it may be made elsewhere. If I can induce someone to order another instrument, we can then try whether two instruments made exactly alike (the word "exactly" being used in the common mechanic's sense of that term) will register velocities alike, or how near alike. Now, to the end of making the new instrument such that it can be regarded as a model, and, (if two instruments made alike, register alike) to the end that our experiments may be considered valid for *many* other like instruments, it has occurred to me that it might be advisable to make the new current meter in the metric dimensions. Of course, it can be *rated* to any desired measures & used in the same; the article itself only, to be bounded & described metrically. How does this idea strike you? Mr. Buff is neutral in the matter, and as for me, I have no decided wish either way; perhaps this is being neutral also. Will you please decide.

When we get a sketch of the proposed instrument I will show it to you before starting on the construction of the instrument. The model for the propeller wheel is to be begun in July, but I will stop it until I hear from you. It is to be a true helicoid, cut into 4 equal parts, and placed around the axis so as to occupy the $\frac{1}{4}$ height of the whole helicoid, a mathematical figure that can be reproduced even should the model be lost.

Truly yours,
[signed] Clemens Herschel

In a second letter, dated 22 September 1876, that Herschel wrote to Francis, he transmitted a list of ideas he had in mind for the new meter.

General Plan for Current Meter

1. The propeller wheel to be abt. 5" diam., each $\frac{1}{4}$ part of a true helicoid of 5" rise. This makes the wheel $1\frac{1}{4}$ " deep. A guard rim at periphery. The wheel to be set well forward of the rest of the instrument.
2. The two journals to be agate; the collar & the end-pivot of German silver.
3. The propeller wheel and the axis that turns with it, to

be without weight in water; this to be attained by making the axis hollow.

4. The counter-wheels, throw-in & out gear, & general frame, like the one owned by Locks & Canals & the one once owned by C. Herschel, now by Genl. Ellis.
5. The frame to be a *closed* box, however, the side next the figured side of the counter wheels of glass, and so arranged that it may be filled with water.
6. The spindle large enough to hold a $2\frac{1}{2}$ inch rod.
7. All the dimensions of the instrument to be some even measure, & the shapes mathematical shapes, so that the instrument can be reproduced from its description.

(2 & 3, I should expect, will about annihilate [sic] the friction at the axis. 5 causes all the parts to move always in the same medium, whether working in clean or gritty water, etc.)

Sept. 22, 1876

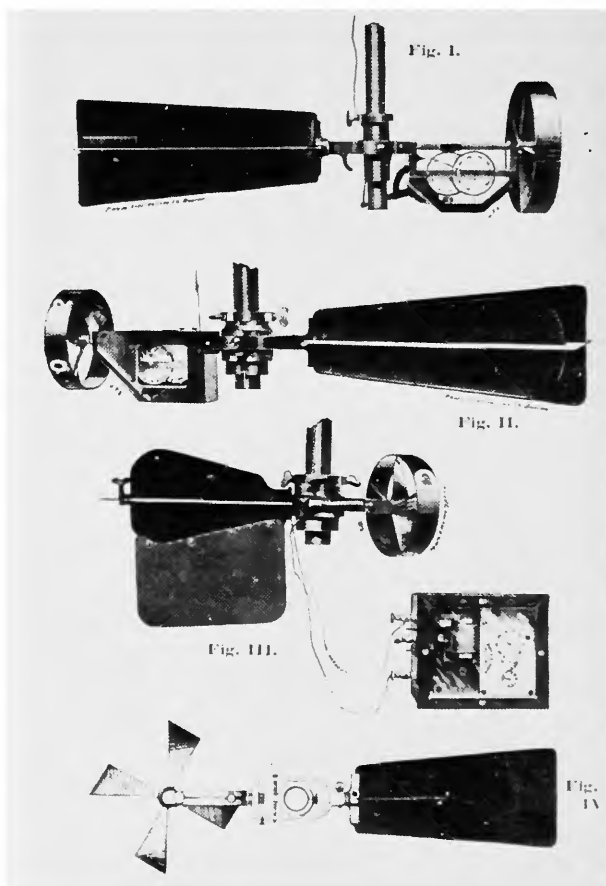

FIGURE 63.—Current meters in the 1885 catalog of Buff and Berger, Boston, probably the first American firm to list such meters in its catalog: *a*, copy of Baumgarten meter requested by Ellis for the Boston water-supply project; *b*, *c*, meters made for Proprietors of Locks and Canals, Lowell, Massachusetts; *d*, Ellis' cup type meter.

In connection with this development project, three different experimental rotors were built. Two of them had four helicoidal blades each, and one had five of them. One had just a plain metal band surrounding the blades, the other two had flat, hermetically sealed tubes in that location. Those tubes, being filled with air like the balls on the Révy current meters, caused the rotors to have the same weight as water, thereby reducing the pressure (and consequently the friction) on the bearings. The two rotors that had the "weightless" feature were six inches in diameter, whereas the one having just a plain band around it, was five inches in diameter. All three of these rotors have been preserved, and are in the Smithsonian collection (Figure 62).

The final outcome of all the experiments and negotiations was that two models were produced. Both had agate main bearings. One (Figure 63*b*) continued the original use of counting wheels (but they were inclosed within a glass-covered box filled with clean water to keep out grit and fibers); the other (Figure 63*c*) used the electrical-contact system which eliminated the counting gears. An article, entitled "Current Meter—from advance sheets of Buff and Berger's enlarged catalog of Improved Engineer's Instruments," appeared in the 25 April 1878 issue of *Engineering News* and stated in reference to these meters that

careful experiments were made at Lowell, in the summer of 1877 under the direction of James B. Francis, Engineer of "The Proprietors of Locks and Canals on Merrimac River" and warrant to say that velocities as low as 0.17 of a foot per second can be measured.

To have reduced the minimum velocity at which the meter could operate dependably from 0.70 to 0.17 feet per second was indeed an important accomplishment. It is believed that Buff and Berger is the first American firm ever to have listed current meters in its catalogs.

Other American Models

Hall's Current Meters

While the Baumgarten current meter was making hydrometric history in the northeastern corner of the United States, something of a similar nature (although not as extensive) was occurring in the Far West. It began in 1877 and 1878 when the Saxton current meter (as modified by General Abbot) had been used by the Corps of Engineers while making a



FIGURE 64.—William Hammond Hall, California's first State Engineer. (Courtesy of Mrs. Hosea Blair.)

study of the currents in San Francisco Bay (see Figure 55). During the latter of those two years, William Hammond Hall (1846-1934) became California's first State Engineer (Figure 64), during which time he is most remembered for his conception and creation of San Francisco's magnificent Golden Gate Park. When the State legislature established a new Department of Engineering as of 29 March 1878, it stipulated that its primary objective should be to ascertain why the Sacramento and San Joaquin rivers flooded so frequently. California thereupon became the first State in the Union to engage in organized stream-gaging activities, preceding the federal government by all of ten years in that respect.

As State Engineer, William Hammond Hall was immediately faced with the problem of obtaining equipment with which to measure the flow of those rivers. The solution thereto was ultimately published in a report,⁸³ which stated in part: "Six current meters were used by the Department. Two of these were the property of the Engineer Corps of the U.S. Army, and four others were closely patterned after these two." From the description of those meters which fol-

lowed, there can be no doubt that the two Corps of Engineers' meters were of the same type (if not the identical instruments) as had been used in San Francisco Bay. With respect to the other four meters (undoubtedly built in California), the writer added: "The blades of the wheels should be heavier, and their upper and front edges should be made sufficiently conical in outline to ward off floating leaves, twigs, etc."⁸⁴

Later in his career, Hall was employed in the Irrigation Survey of the U.S. Geological Survey. A few of his current meters were acquired by that Survey for use in its early stream-gaging program. Two of those meters—one intended to be used while suspended from a rod, the other while suspended from a cable—were preserved and in time transferred by the Geolog-

ical Survey to the Smithsonian Institution (Figure 65).

The Haskell Current Meter

Almost every hydrographer worth his salt, who had used a current meter designed by someone else, seems to have come up with a better design of his own. So it was with Eugene Elwin Haskell (1855-1933) (Figure 66). He graduated from Cornell University in 1879. His earliest job experiences were in Detroit as a recorder for the Survey of the Northern and Northwestern Lakes (now more commonly referred to as the "U.S. Lake Survey"), and in charge of a party of engineers employed by the Mississippi River Com-

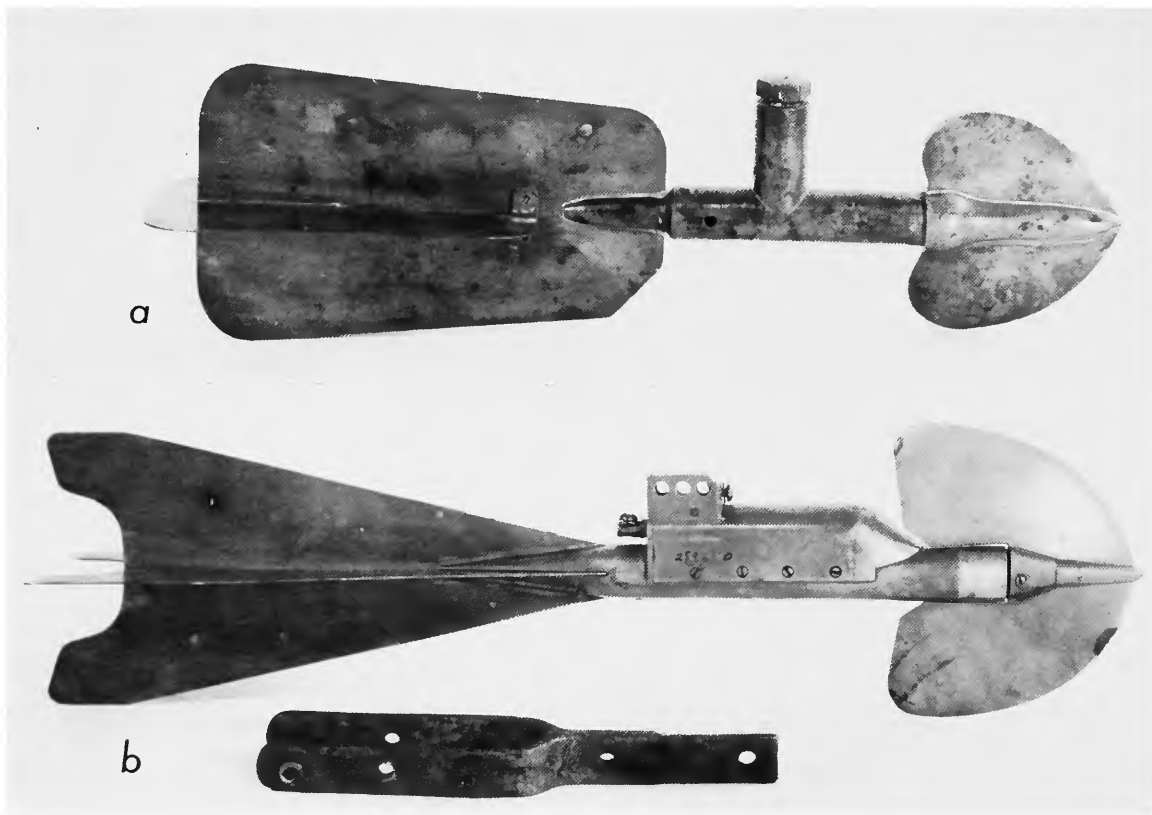

FIGURE 65.—Hall's current meters designed ca. 1880: *a*, meter for use with rod suspension (NMHT 289639, Smithsonian photo 445537-F); *b*, meter for use with cable suspension (NMHT 289640, Smithsonian photo 44537-G).



FIGURE 66.—Eugene Elwin Haskell, Dean, College of Engineering, Cornell University, 1906-1921. (Courtesy of Cornell University.)

mission, measuring the discharge of the Mississippi River at Point Pleasant, Missouri.

During the period 1885 to 1893, Haskell was employed in the U.S. Coast and Geodetic Survey. One of his first assignments there was to plot, under Professor Henry Mitchell's supervision, the direction and magnitudes of the currents in New York Harbor. It was while he was so employed that he invented his current meter. It differed from the cup-type meters then in vogue on the Mississippi River in that his was of the earlier horizontal-axis, screw-type design, and it included a direction-indicating facility. To quote Haskell's *Reminiscences*:

Mr. E. S. Ritchie, inventor of the liquid compass, had solved the problem of reading a distant compass electrically; accordingly I joined forces with him and a direction current meter was the result. This was put in use in the Spring of 1886 on the New York Harbor work.⁸⁵

Haskell later used this current meter in a study of the currents off the Florida coast and in the Gulf Stream. As of 12 June 1888, U.S. Patent No. 384362 was awarded to him for it (Figure 67). For many years thereafter, the E. S. Ritchie firm in Brookline, Massachusetts, manufactured them.

In the course of his eventful and eminent career, Haskell became a member of several important re-

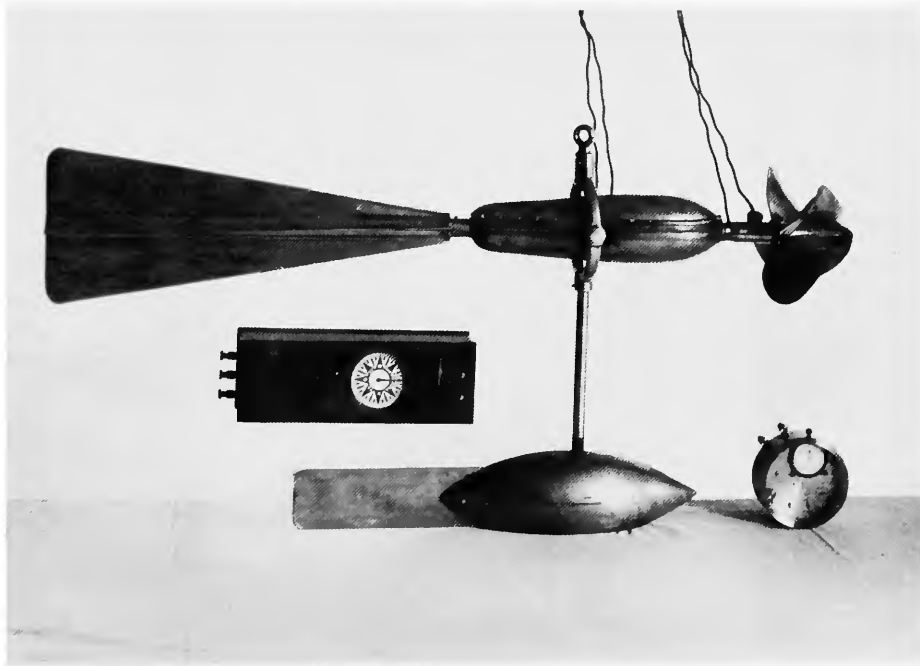

FIGURE 67.—The Ritchie-Haskell direction-indicating current meter. (Courtesy of U.S. Geological Survey.)

gional, national, and international commissions dealing with hydraulics. In 1906 he became Dean of the College of Engineering at his old alma mater, Cornell University, a position he held until his retirement in 1921.

U.S. Irrigation Survey Models

On 2 October 1888, Congress passed a Sundry Civil Bill appropriating \$100,000 for studies concerned with irrigating the lands west of the 100th meridian. The new agency was called the United States Irrigation Survey, and made a part of the Geological Survey in the Department of the Interior. One of its first objectives was to establish a temporary camp of instruction on the Rio Grande at Embudo, New Mexico, for training a group of young engineers in the art of gaging streams.⁸⁶

At the time that bill was passed, the Geological Survey did not have any current meters or other stream-gaging equipment with which that group could gain the desired experience. John Wesley Powell, then Director of the Survey, appealed to some of the other likely federal agencies for the loan of any such instruments that they might have to spare. While waiting for those agencies to respond, the group made measurements with different types of floats fashioned

from locally available materials, and also by running levels down the stream to determine its slope, and computing the discharge from existing formulas.

Powell's appeal eventually met with one lone response. The Navy Department shipped to the camp a 36-inch-long, cable-suspended Ritchie-Haskell direction-indicating current meter, such as shown in Figure 67. It, however, turned out to be far too large and much too cumbersome for use in the shallow waters which normally occur at Embudo during the winter seasons. This being the only current meter available up to this point, they immediately set about redesigning it in a manner that would better serve their needs. One of the group was sent with the resulting plans to an instrument-maker in Denver, and within a short period of time a much smaller and more convenient model, similar to that shown in Figure 68 (but arranged for rod suspension), was produced and placed in service.

During the years that followed, almost a dozen variations from the Irrigation Survey's (and William Hammond Hall's) models were tested. Four of them along with the direction-indicating meter, were added to E. S. Ritchie and Sons' line. Two of those four models (Figures 68 and 69) are now in the Smithsonian collection. The one shown in Figure 69 was listed in the catalogs as "Current Meter 'B' complete with lead weight and extra wheel." The rotors or

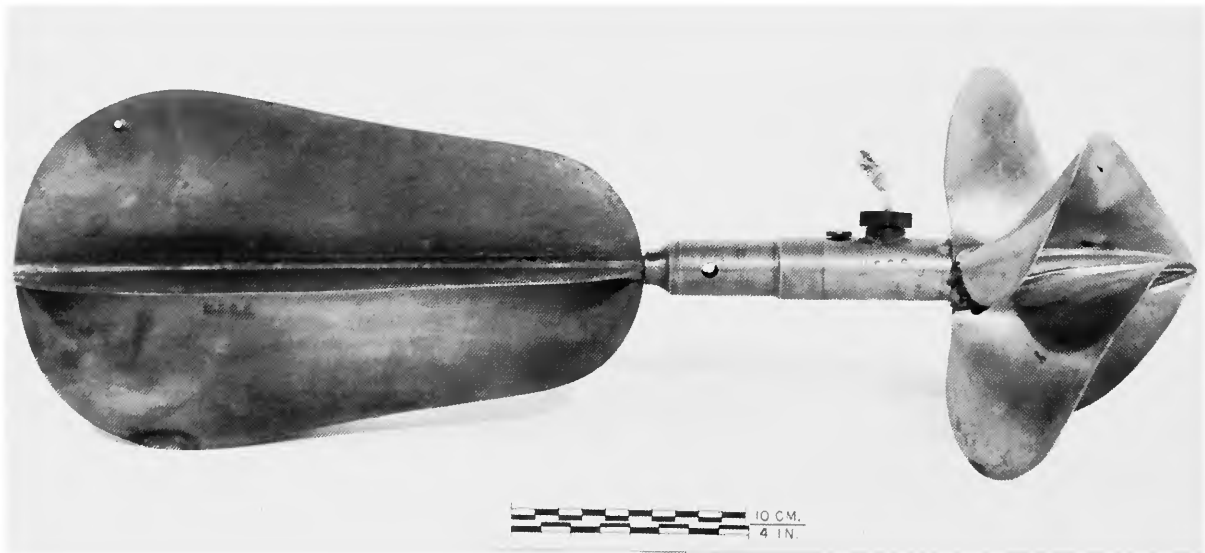

FIGURE 68.—A variation of the Haskell current meter as conceived in 1888-1889 by engineers of the U.S. Irrigation Survey. (NMHT 248697, *Smithsonian photo 44537-B.*)

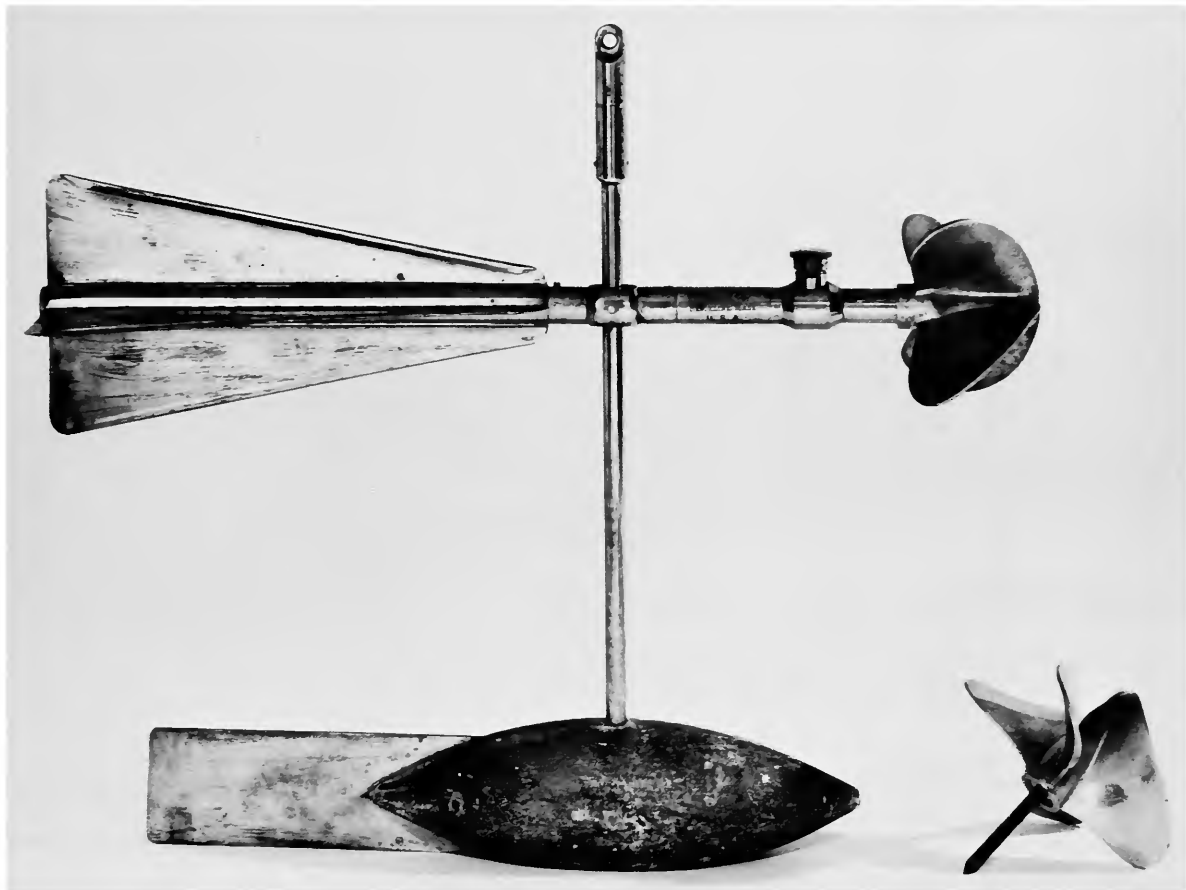

FIGURE 69.—Current Meter B (an early variation of the Haskell current meter) with sounding weight, manufactured by E. S. Ritchie & Sons, Brookline, Massachusetts, ca. 1900. (NMHT 316590, Smithsonian photo 72237.)

“wheels” then in use had diameters ranging from $7\frac{1}{2}$ inches down to $5\frac{1}{2}$ inches. Some had a high (screw) pitch, others had a low pitch. The latter would operate better in the lower velocities, although they ceased to perform reliably below 0.5 foot per second. When operating in velocities above say four feet per second, they revolved so rapidly that their revolutions could not be counted accurately. The slower turning, higher pitched wheels would then be installed on the meters.

In 1889, the activities of the Irrigation Survey were practically brought to an end, but in 1904, the Water Resources Branch of the Geological Survey was officially activated, and stream-gaging operations were revived not only in the area west of the 100th meridian, but throughout the entire United States. This work is

still being carried on. At present the more recently designed, vertical-axis, Small Price current meter (on which only a single rotor is required) is the favored instrument of the Survey, but for several of its earliest years, meters of the type just described had been preferred.

Other European Developments

Moore's Current Meter

While the foregoing events were taking place in the United States, European engineers were also taking considerable interest in the design of current me-

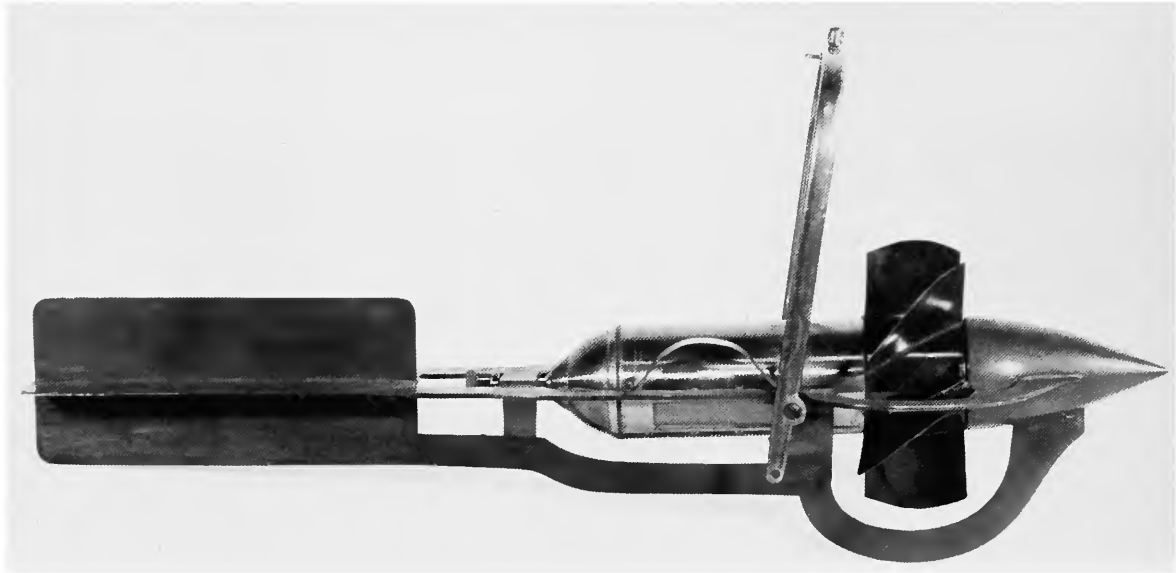

FIGURE 70.—A current meter patented in 1875 in the United States by Benjamin T. Moore of Middlesex County, England (NMHT 308551, Smithsonian photo 44536-H.)

ters. The Saxton and Révy meters manufactured by Elliott Bros. in London, and the Baumgarten meters manufactured by Lerebours and Secretan in Paris, have already been discussed, but no mention has yet been made of the Moore or Ott meters made respectively in England and Germany.

Benjamin T. Moore obtained a U.S. Patent (No. 169024, dated 19 October 1875) for his "current meters, water meters, and ships' logs." On 1 January 1876, he used the current meter to measure the flow of the Thames River at Staines, about 20 miles upstream from London. (The discharge amounted to 2612 cubic feet per second.)

At the time this patent was granted to Moore, current meters were all classified by the U.S. Patent Office under "Ships' Logs."

The earliest American patents for current meters were taken out in 1851. There are now [1927] on file in the Patent Office, classified under ships' logs, more than 50 patents for devices for measuring the velocity of water. Many unpatented devices have also been constructed.⁸⁷

Moore not only described his instruments in his patent, but he also submitted to the Patent Office a model of his current meter. That model was later trans-

ferred to the Smithsonian Institution (Figure 70).

The Firm of A. Ott

In 1790, Reinhard Woltman publicly introduced his horizontal-axis water current meter. Its basic design soon became traditional and many of the improved models which came after it were called "Woltman" meters, out of respect for the original inventor. A firm that perhaps has done the most to preserve this tradition is that of A. Ott of Kempten, Bavaria—today in West Germany. Albert Ott (1847-1895), its founder (Figure 71a), was the son of a farmer and postmaster in Nesselwang, South Bavaria. After serving an exacting apprenticeship in the shop of his uncle, Clemens Riefler, who manufactured drawing instruments in Nesselwang, he attended the Polytechnic School in Munich. For short periods thereafter, he worked at instrument shops in Munich, Vienna, Berlin, London, and Milan before returning to Bavaria.

In 1873, A. Ott and G. Coradi became partners in a small shop in Kempten, where they manufactured surveying instruments. Seven years later, however, Coradi left for Zurich to establish a separate, and subsequently famous, shop of his own.

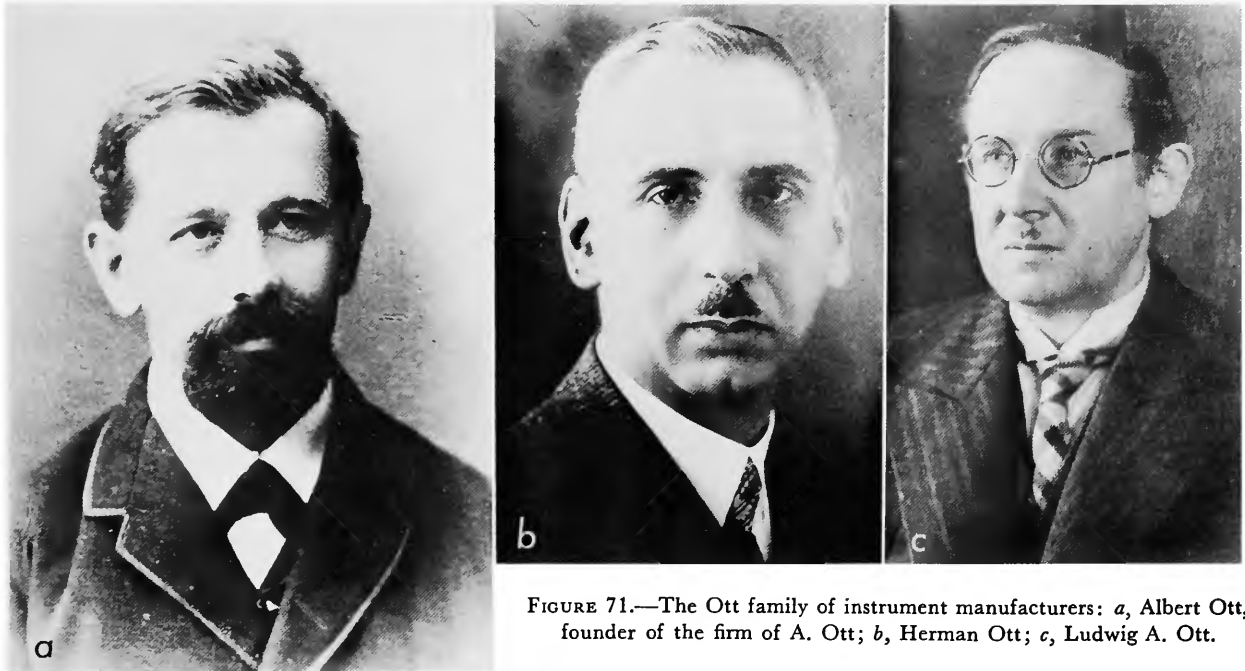

FIGURE 71.—The Ott family of instrument manufacturers: *a*, Albert Ott, founder of the firm of A. Ott; *b*, Herman Ott; *c*, Ludwig A. Ott.

Upon being left the sole owner of the shop in Kempten, Ott sought ways of increasing his line of scientific instruments. In 1881, therefore, when a leading hydraulic engineer, Professor Andreas Rudolph Harlacher, head of the Hydrographic Services in Bohemia, proposed to Ott that he manufacture Woltman current meters supplied with electric registering facilities on which Harlacher possessed a patent, Ott complied eagerly. Ever since then, the Ott firm has supplied Germany and many other countries throughout the world with current meters, practically all of which have been of a horizontal-axis type such as Woltman had originally conceived.

This was a family-owned firm, and when Albert died, it was inherited by his two sons, Herman (Figure 71*b*) and Ludwig (Figure 71*c*) with Ludwig (when coming of age) taking the most active part in its operations. In the course of time, Ludwig received a Doctor of Engineering degree from the Technical University in Munich, and was honored for the excellence of his hydrometric, cartographic, and mathematical instruments. Among the several instruments manufactured by the Ott firm that have been contributed to the Smithsonian Institution are the two fairly recent current meters shown in Figure 72.

After Ludwig Ott's death in 1946, his elder brother,

Herman, carried on the administrative and developmental work.

Steponas Kolupaila

During the course of its highly successful operations, members of the Ott firm collaborated with many distinguished European hydraulic engineers and often incorporated their suggestions into their instruments. The circumstances under which one such engineer, Dr. Steponas Kolupaila (1892-1964) became involved warrants special attention here.

Before World War II, Kolupaila had been in charge of Lithuania's Hydrometric Bureau, an agency which was comparable to that of the Water Resources Division of the U.S. Geological Survey. Data concerning the discharge of rivers in Lithuania were collected and published under his supervision, as was the rating and repair of the current meters used on such work. In fact, the meters used in neighboring countries like Estonia and Latvia were often sent to him to be rated.

In 1940, Estonia, Latvia, and Lithuania were overrun by the Russian army, and their freedoms as independent republics came to an end. Dr. Kolupaila was among the few scientifically trained engineers who

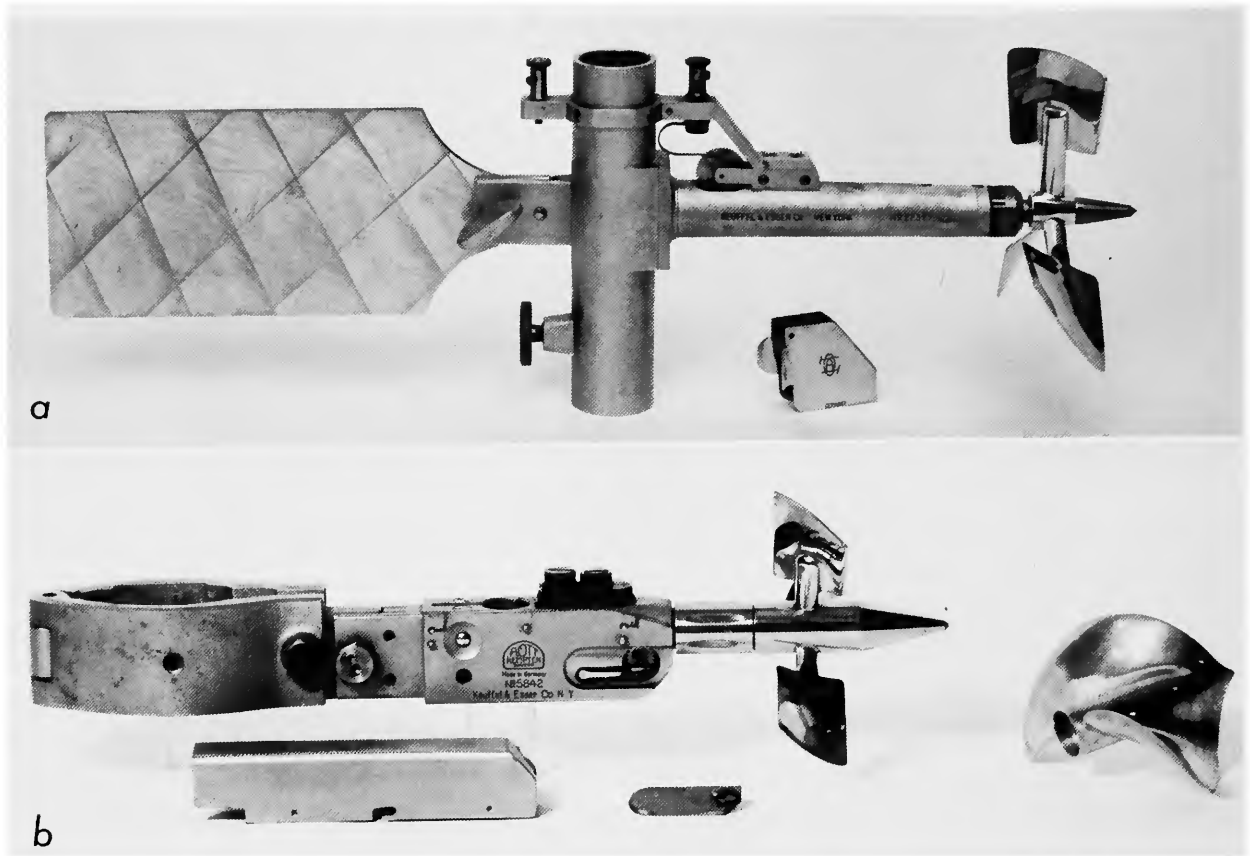

FIGURE 72.—Ott current meters: *a*, ca. 1917 (NMHT 316593, Smithsonian photo 72242); *b*, ca. 1932 (NMHT 316595, Smithsonian photo 72256).

fled to Germany, where he found employment in the firm of A. Ott. One of his projects during the four years while he was there was to develop a rotor for use on horizontal-axis meters that would register only that component of the velocity of a stream which corresponded with the direction in which the meter was pointing. In other words, if a meter held on a rod, were pointed directly into the current, the rotor would register 100 percent of the velocity in effect there, whereas if it were pointed at right angles from that direction, the rotor would not turn at all. At any intermediate angle, the rotor would revolve at a rate which represented the corresponding component of the velocity. This innovation is of particular importance where a meter can be held in a fixed position and used in highly turbulent water, or in places where water tends to flow at unpredictable angles such as occurs in the vicinity of hydraulic turbines.

Kolupaila succeeded in developing such a rotor. Before leaving that firm in about 1944 to accept a position in America as Professor of Civil Engineering at the University of Notre Dame, the Ott firm presented him with one each of the major instruments on which he had contributed improvements. The instrument case containing a current meter with his "component" rotor, carries a brass plate engraved as follows:

TO OUR HYDROMETRICAL COLLABORATOR
PROFESSOR STEPONAS KOLUPAILA
IN GRATITUDE FOR VALUABLE SCIENTIFIC WORK
A. OTT, MATH. MECH. INSTITUTE
KEMPTEN, BAVARIA

After Kolupaila's death in 1964, that case of current meters, which included numerous accessories, was presented to the Smithsonian Institution (Figure 73). His "component rotor" appears in Figure 74.

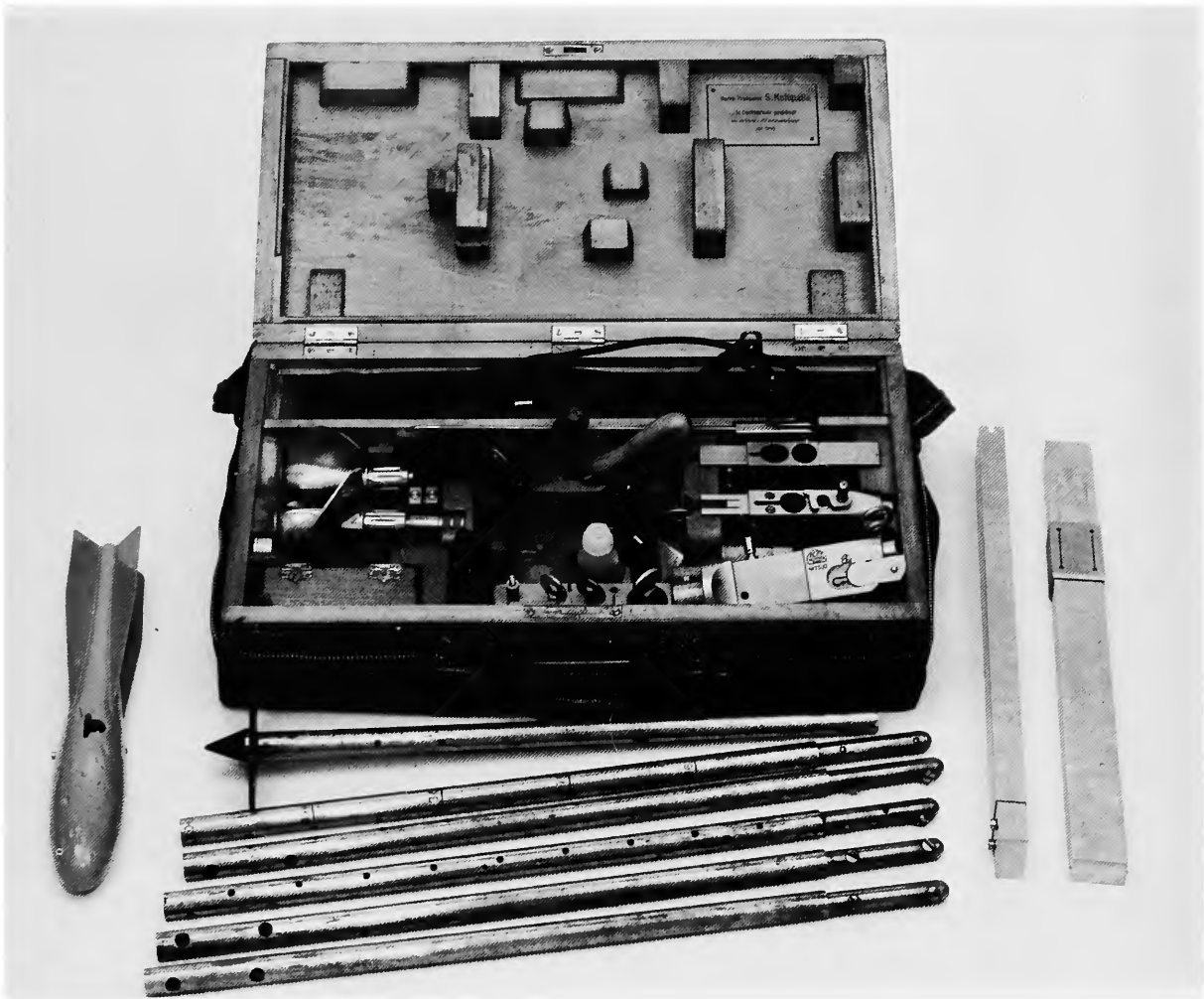

FIGURE 73.—Current meters and accessories presented to Dr. Steponas Kolupaila for designing the “component rotor.” (NMHT 328631, Smithsonian photo 62664.)

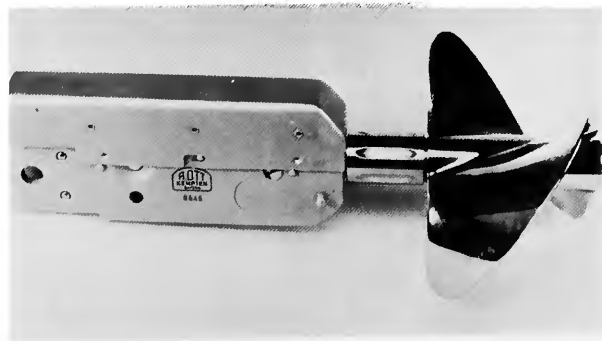

FIGURE 74.—A modern Ott meter equipped with Kolupaila’s “component rotor.” (NMHT 328631, photo by A. H. Frazier.)

VERTICAL-AXIS METERS

During the development of instruments for stream gaging, a number of current meters were produced, which, although never generally accepted, are never-

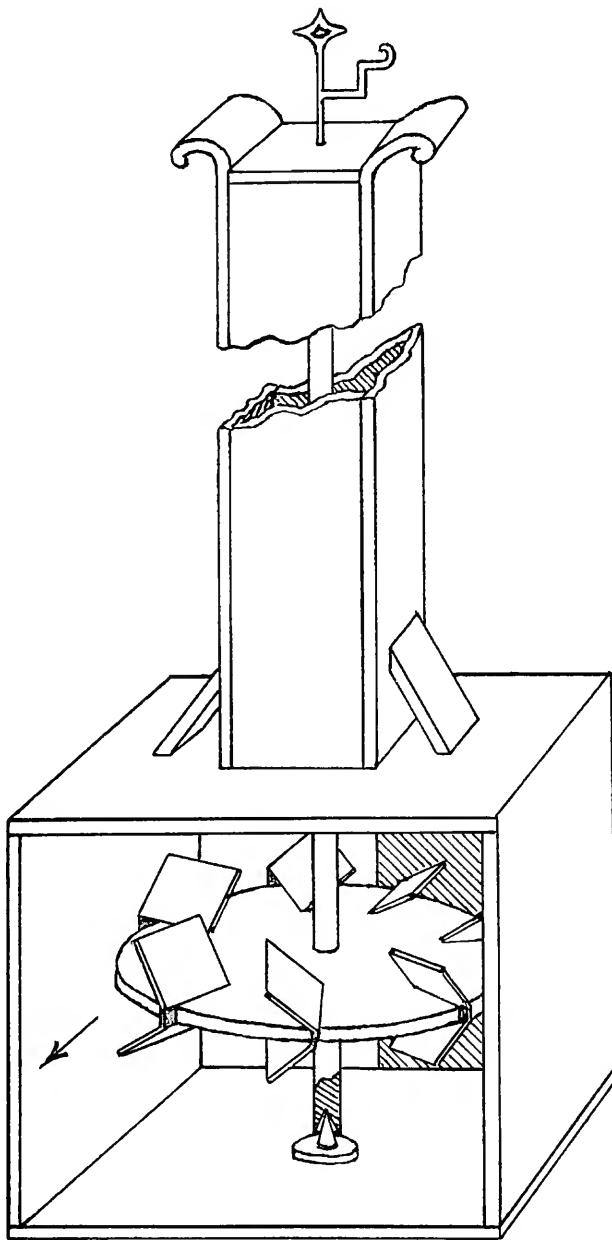

FIGURE 75.—Tolotti's "rota idrometrica," ca. 1823, a forerunner of modern vertical-axis current meters. (Drawn by A. H. Frazier, from Tolotti, *Rota Idrometrica*.)

theless of considerable historical interest. Such was the case with the Hooke and Focacci meters, previously discussed, and such was the case with the little-known Tolotti meter.

Most of the presently available information concerning the Tolotti meter is contained in a little pamphlet entitled *Rota Indrometra*, by Antonio Semipiterni Tolotti. The drawings in that pamphlet were obviously prepared by an unskilled draftsman, so a more readily understood modern perspective drawing thereof is being presented in Figure 75. The apparatus consisted of a circular rotor with seven equally spaced, V-shaped vanes around its periphery, all mounted within a box-like container. The downstream face of that container was left completely open, but a half of its upstream face was closed to form a shield for the vanes moving in the upstream direction (a practice followed in several modern instruments). Its axle was supported on an upward-pointing pivot (also a modern practice). The axle projected well above the surface of the water, where a pointer was attached to it, which enabled the operator to count and time its revolutions. Although this apparatus badly lacked streamlining, the principle of its operation is essentially the same as that of many modern current meters.

The Tolotti current meter in turn had forerunners

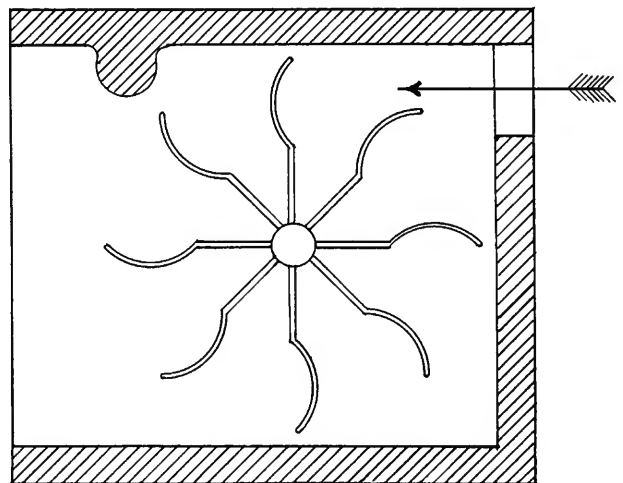

FIGURE 76.—Cross-section of early Persian windmill, a forerunner of the Tolotti current meter. (Drawn by A. H. Frazier after Vowles, "Early Evolution of Power Engineering," plate 24.)

of its own but in the meteorological field. For example, in an article entitled "Early Evolution of Power Engineering" by Hugh P. Vowles is a "diagrametric cross-section of a Persian windmill," a copy of which

appears in Figure 76. The windmill too, operated on the same principle, and Vowles implied in his article that such windmills may have been used in Persia as early as the 7th century A.D.



FIGURE 77.—Daniel Farrand Henry. Note parts of a current meter and counting mechanism on table; cf. Figure 78. (Painting by Percy Ives, courtesy of Prismatic Club, Detroit, Michigan.)

The Henry Meter

The current meter that initiated the present vogue of current meters of the vertical-axis type was the one designed by Daniel Farrand Henry (1833-1907) of the U.S. Lake Survey in 1868 (Figure 77). A replica of the meter is now in the Smithsonian collection (Figure 78).

Not long after the Civil War, Henry (no relation of Joseph Henry, the first Secretary of the Smithsonian Institution) had received orders from his supervisor, General William Franklin Reynolds, to measure the discharge from several of the Great Lakes. During the course of that project, he built a current meter like that shown by installing a flier (rotor) from one of his Robinson cup-type anemometers into a suitable frame and fitting it with an electric contact facility for counting its revolutions (the first successful device of that nature). He rated the assembly in the still waters of a convenient reservoir. The complete story regarding this historic meter appears in the Fall 1964 issue of *Technology and Culture*.⁸⁸

Despite the fact that both Henry and his supervisor were severely disciplined by the Chief of Engineers, General A. A. Humphreys, for not having followed the "double float" method prescribed in the famous Humphreys and Abbot report on the Mississippi Riv-

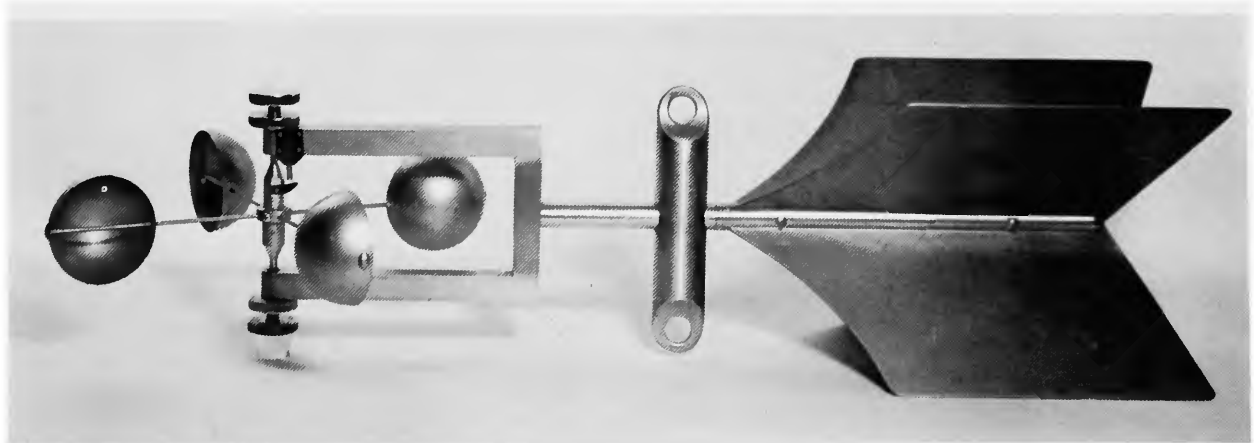

FIGURE 78.—Replica of Henry's cup-type, electric-contact current meter. (NMHT 317670, Smithsonian photo 72258.)

er, this meter started the vogue favoring vertical-axis cup-type current meters, which persists throughout North America to this very day.

When, in 1876, the United States International Exhibition was held in Philadelphia for commemorating the Nation's first centennial, Henry was persuaded to exhibit his current meter and an inlet pipe strainer for water works as a part of the display of the American Society of Civil Engineers (an organization of which he was a member). Because of the electrical counting facility he had installed on that meter, it became classified among the "electric" rather than the "hydraulic" instruments at the exhibit. Joseph Henry of the Smithsonian Institution judged those instruments, and it was he, therefore, who wrote the following Judge's report awarding Henry a medal for his exhibits:

AWARD 351: D. FARRAND HENRY, DETROIT, MICHIGAN, U.S.A. CURRENT METER AND INLET PIPE AND STRAINER FOR WATER WORKS

Report

Commended for an improvement on the ordinary form of current meters and for the application of electricity to the recording part of the instrument; also for the arrangement of a strainer and inlet pipe for water works, so as to prevent the interruption from the accumulation of anchor ice.⁸⁹

The Ellis Meters

The man who had persuaded D. F. Henry to exhibit his current meter at the Philadelphia exhibition, was General Theodore Grenville Ellis (1829-1883) (Figure 79), a vice-president of the American Society of Civil Engineers, and the Chairman of its Centennial Commission. During the Civil War, he had participated in the Battle of Antietam and no less than 23 other engagements while pursuing General Lee to Appomattox. After the war he returned to Hartford, Connecticut, where he had made his home since 1854, and resumed his engineering activities. In 1867 he was placed in charge of the U.S. Corps of Engineers' navigation-improvement study of the Connecticut River, a job on which he remained for about ten years.

While measuring the flow of the Connecticut during his earlier years on that job, he initially followed the procedure recommended in the Humphreys and Abbot report, namely that of using the double-float method. Like Daniel Farrand Henry in the Great Lakes area, however, he ultimately decided to give



FIGURE 79.—General Theodore G. Ellis.
(Courtesy of Library of Congress.)

current meters a trial. One of his first steps in that direction was, as previously stated, to acquire the Baumgarten meter which Clemens Herschel had purchased from the Secretan firm in Paris (Figure 57).

In the meantime, Henry, with the consent of his supervisor, General Reynolds, had been using his cup-type current meter with gratifying success. Reports thereon were being printed in the same House and Senate Executive Documents in which the reports of Ellis' own work on the Connecticut River were being published, so he became fully aware of them as well as aware of the criticism which the Chief of Engineers Humphreys was heaping upon those two hapless Lake Survey engineers. Despite that criticism, Ellis proceeded in 1874 to build a current meter very similar to, but much smaller than, Henry's. His official report thereon, supported by his own immediate superior, General G. K. Warren, was expressed in such diplomatic language that Humphreys even praised his action. By the time the Ellis' report of 20 March 1875

was being prepared, the controversy in the Corps of Engineers about the use of current meters had subdued to such an extent that Ellis ventured to add the following footnote to his description of the new current meter:

A telegraphic current-meter was first used by D. Farrand Henry, esq., civil engineer, upon the United States lake survey, and to whom the writer is much indebted for valuable suggestions in the use of the instrument. A full description of Mr. Henry's meter will be found in the *Journal of the Franklin Institute*, volume LXI.⁹⁰

Figure 80 shows the two earliest versions of his meter, both of which are in the Smithsonian collection. They differ from each other in that the more recent model (Figure 80*b*) is provided with a "contact chamber" which houses both the upper bearing of the rotor as well as the electric contact facility. In the earlier model (Figure 80*a*), the contacts took place in the open water, the method that had been used on the Henry meters. It may be noted that the original

model corresponds exactly with the illustration in Buff and Berger's 1885 catalog, as previously shown in Figure 63.

The use of Ellis meters spread quite rapidly after he had rated his first model in June 1874, particularly among the hydrographers of the Corps of Engineers (then the largest group of current meter users in the United States). With the introduction of the meter designed by W. G. Price in 1882, however, its popularity soon came to an end (page 78).

The Nettleton Meter

Edwin S. Nettleton (1831-1901) (Figure 81), was born in Medina, Ohio, and educated at the Medina Academy and Oberlin College, after which he became an apprentice of Zacharia Deane in civil and mechanical engineering. He reached the age of maturity when Horace Greeley's admonition, "Go West, young man,



FIGURE 80.—Early Ellis current meters: *a*, as originally designed (NMHT 317669, Smithsonian photo 72257); *b*, with first improvement (NMHT 289637, Smithsonian photo 44538).

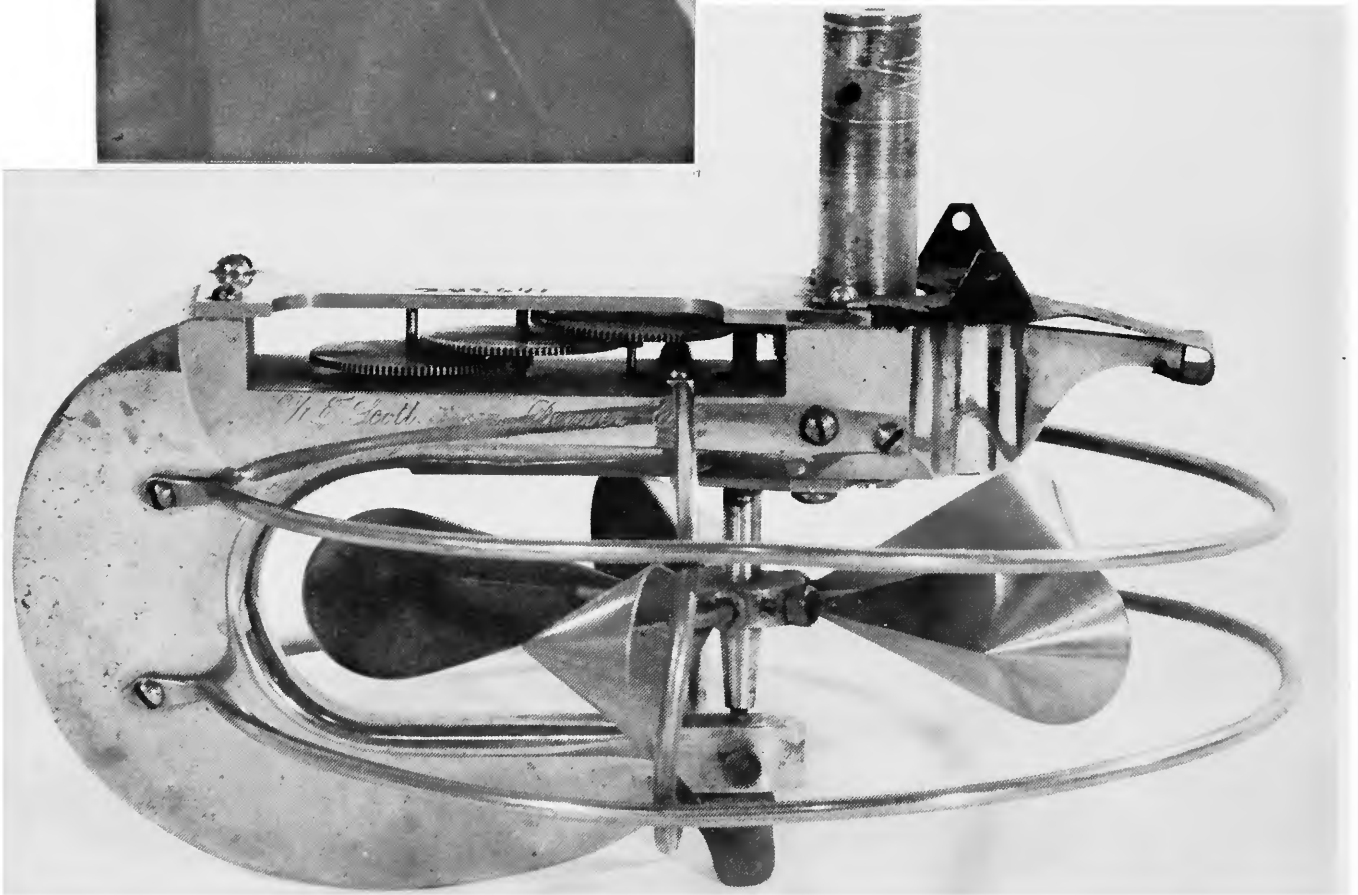

FIGURE 81.—Edwin S. Nettleton and his current meter. (Portrait from Eleventh Biennial Report of the State Engineer to the Governor of Colorado for the Years 1901 & 1902; meter NMHT 289641, Smithsonian photo 44537-H.)

and grow up with the country," began to have its greatest effect.⁹¹

Apparently inspired by Greeley's oratory, Nettleton joined the Union Colony emigrating to Colorado in 1870 as its engineer-in-chief. Upon their arrival in that State, he laid out the town and surroundings of Greeley, and built its irrigation canals. In 1871 he laid out the towns of Colorado Springs and Manitou, complete with a canal system for that area.

By 1881 the legislature of Colorado had appointed its first State Engineer, one Eugene K. Stimson, who served in that capacity for the fiscal years of 1881 and 1882. He was followed by Edwin S. Nettleton, who



carried that work forward for the next four years. It is of interest in this connection that during most of those years his Assistant was Ellwood Mead, for whom Lake Mead, the lake impounded by the well-known Hoover Dam between Arizona and Nevada, has been named.

Of greater interest, insofar as the present study is concerned, is the current meter that Nettleton designed. In his account of the stream-gaging operations published in the *Biennial Report to the Governor of Colorado for 1883-1884*, he remarked:

At first the Fteley current meter was used for measuring current velocity, but it was soon apparent that this instrument was entirely too delicate for the rough torrents, filled with drift of all sorts, in which it was necessary to use it. *An instrument was designed by me more suitable to the work (named the "Colorado" current meter), a description of which is given elsewhere.* The main object kept in view in designing this instrument, was to make it self-clearing, the great defect of the Fteley meter being its liability to error from clogging with grass, weeds, etc. which at times would vitiate many hours' work. . . . Three "Colorado" meters having been made for this department by W. E. Scott & Co. of Denver; these instruments have since been in continuous

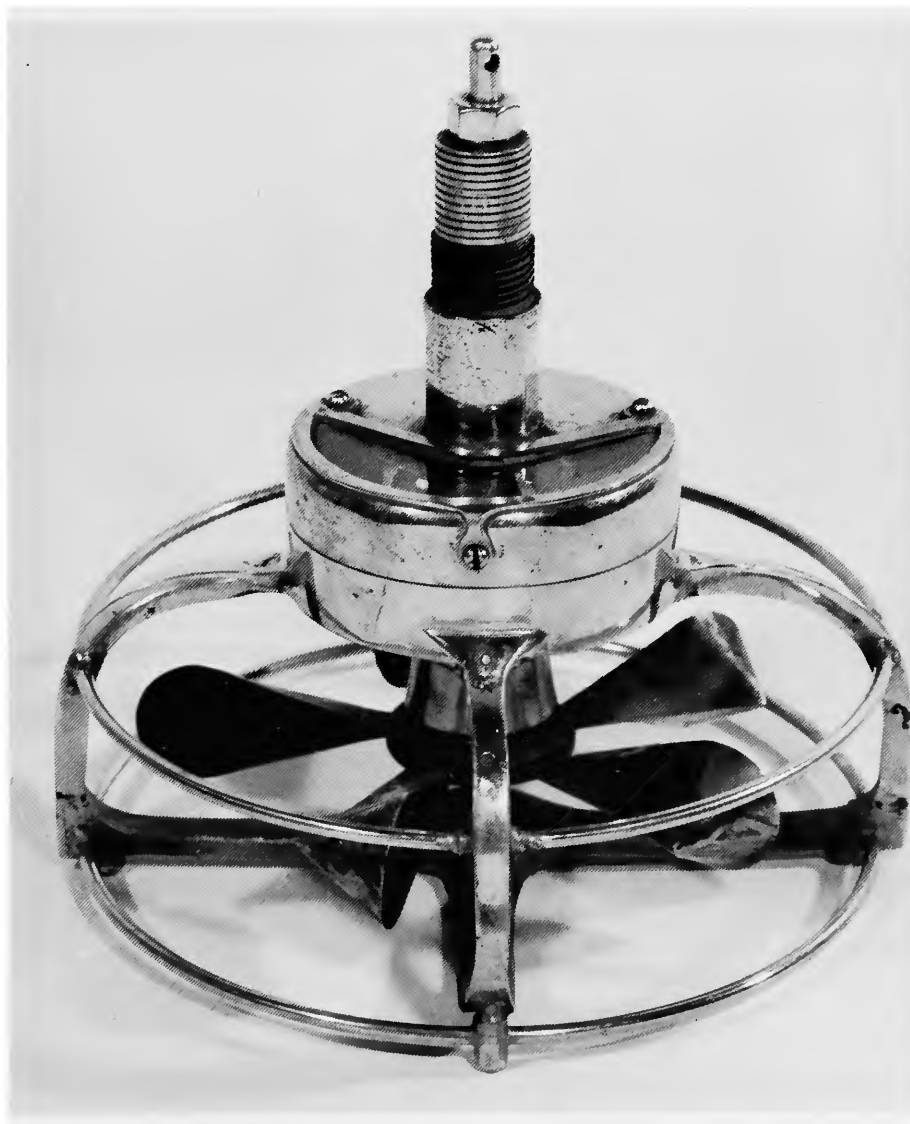

FIGURE 82.—The "Bailey" meter, a modified version of Nettleton's meter, ca. 1889. (NMHT 24896, Smithsonian photo 44538-A.)

use in gauging rivers and ditches giving entire satisfaction."⁹² [Italics added.]

One of the current meters built for him by W. E. Scott & Co. is shown in Figure 81. It will be seen that the major change from the Fteley-Stearns current meter (Figure 61) consisted of substituting a vertical-axis rotor, such as General Ellis had used on his meters, for the horizontal-axis, screw-type rotor that Fteley preferred.

In 1889, after the U.S. Geological Survey's "Camp of Instruction" for the Irrigation Survey got under way at Embudo, New Mexico, Nettleton, like California's State Engineer William Hammond Hall, lent a model of *his* current meter to that Survey. Soon the engineers at that camp redesigned Nettleton's meter, just as they had redesigned the Navy Department's Haskell meter, only this time the change was not as drastic. It consisted merely of enclosing the counting wheels within a glass-covered compartment so as to keep silt and the plant fibers from interfering with the action of the gears. The revised instrument became known as the "Bailey" meter (Figure 82), presumably because most of the change had been accomplished by the junior member of the firm in Denver then known as "Lallie and Bailey." As in the case of the Nettleton meter discussed above, one of these original "Bailey" meters, after having been preserved for many years by the Geological Survey, was transferred to the Smithsonian Institution.

The Price Meters

All of the remaining current meters presently in the Smithsonian collection are vertical-axis, "Price-type" models having cup-type rotors. As in the case of the previously described Woltman meters, numerous modifications have been made from the original model built by Price, but his name has always remained attached to all of them even though some have failed to meet his approval. Meters of this type are by far the most commonly used in North America, whereas those of the horizontal-axis type are the most popular in Europe.

William Gunn Price (1853-1928) (Figure 83) was born in Knoxville, Pennsylvania, but spent most of his youth in Chaseville, New York, about two miles southwest of the picturesque village of Schenevus. His aptitude for invention and engineering became evident quite early, and after having received four years

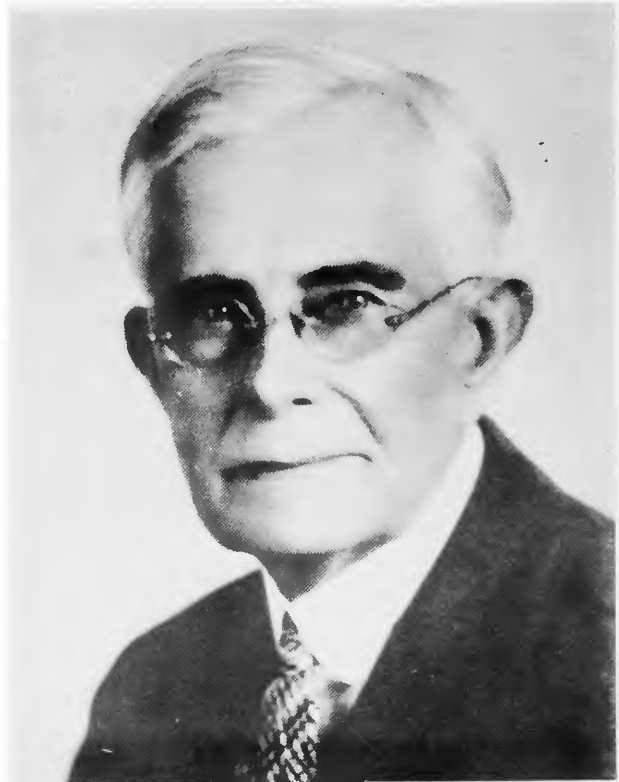

FIGURE 83.—William Gunn Price.
(Courtesy of W. G. Price, Jr.)

of instruction in mathematics and engineering under J. H. Serviss at Englewood, New Jersey, he embarked on a brilliant career in both of those fields.⁹³

Between 1879 and 1896 Price was an assistant Engineer with the Mississippi River Commission, measuring the flows of the Mississippi, Ohio, and Missouri rivers, including many of their tributaries. In 1882, after having installed a river gage on the Ohio River at Paducah, Kentucky (Figure 84), he conceived the design of his first current meter. The circumstances which prevailed on that occasion are described in the following letter which he wrote on 20 April 1927 to Nathan C. Grover, then Chief Hydraulic Engineer of the United States Geological Survey:

In January, 1882, I began measuring the discharge of the Ohio at Paducah, Kentucky, under orders of Captain Smith S. Leach, Corps of Engineers, U.S.A., who was Secretary of the Mississippi River Commission. My equipment included a meter which was designed by Clemens Herschel.

The Herschel meter was of the propeller type, having a horizontal shaft, and there were no means for excluding water from its bearings.



FIGURE 84.—The catamaran used by W. G. Price in 1882 for measuring the flow of the Ohio River at Paducah, Kentucky. Note current meter next to Price, second from right at stern of boat. (Courtesy of W. G. Price, Jr.)

The Ellis meter had a cupped wheel which revolved in a horizontal plane, and there was no provision for excluding water from its vertical-shaft bearings.

I rated these meters in clear, still water, and plotted ratings indicated that they would give accurate measurements.

I then began using them for river measurements. The water was very muddy, and boils in the swift current carried fine sand to the surface which I caught in my drinking cup. Neither would give discharge measurements which corresponded with the gradual increase in gage.

I then rated both meters in a bayou which had been recently filled with muddy water from the river, and the rating dots were irregular in location. Some dots indicated an increase of friction in the wheel bearings.

I then rated the meters in a smooth-flowing chute, carrying sand and fine silt from the river. The meters were moved alternatively upstream and downstream. These ratings were very inaccurate, indicating the effect of grit in the bearings.

I then wrote to Captain Leach that using these waters, I was unable to secure discharge measurements which at all corresponded with the daily increase in stage. The river was

having a slow continuous rise. I asked Captain Leach to send me a meter which would give accurate measurements. The next day at 5 p.m. I received the following telegram: "Have no meter to send you. Do the best you can."

Almost immediately the idea occurred to me that by using inverted cup bearings which would trap air, I could exclude the water and grit. I made drawings for such a meter that night, and by employing four mechanics, the meter was completed the next day at 3 p.m.

This meter was used for measuring the great flood of that year, 1882.⁹⁴

In other documents, Price explained that among those mechanics he had employed to build the meter was a tinsmith, a blacksmith, and a locksmith. They were the best mechanics in town. The actual current meter constructed on that occasion is now one of the most treasured current meters in the Smithsonian collection (Figure 85).

Among the many U.S. patents that have been awarded to Price, the following four were for current meters: No. 325,011 dated 25 August 1885; No.



FIGURE 85.—The original Price current meter, built by him and four mechanics at Paducah, Kentucky, in 1882. (NMHT 289638, Smithsonian photo 44538-H.)

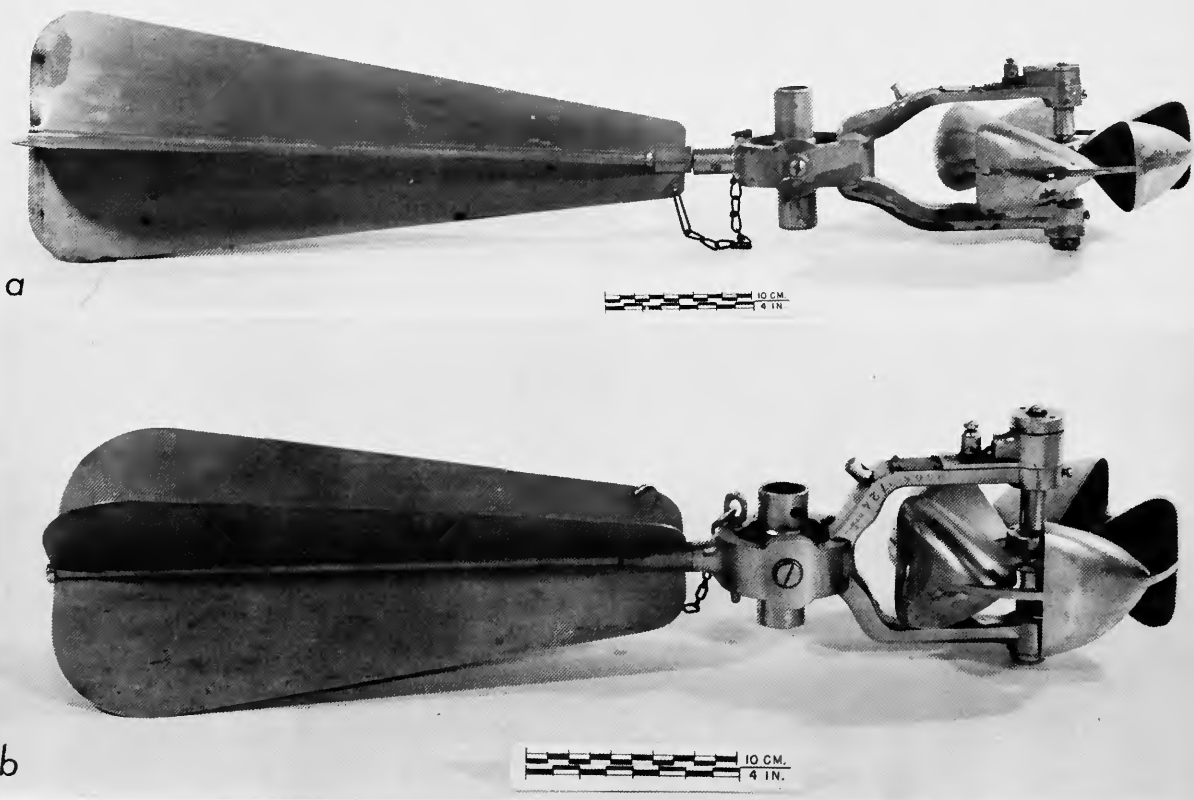

FIGURE 86.—Price's current meters, ca. 1886, manufactured by W. & L. E. Gurley: *a*, 34-inch-long version (NMHT 311708, Smithsonian photo 44538-D); *b*, 24-inch-long version (NMHT 289642, Smithsonian photo 44538-G).

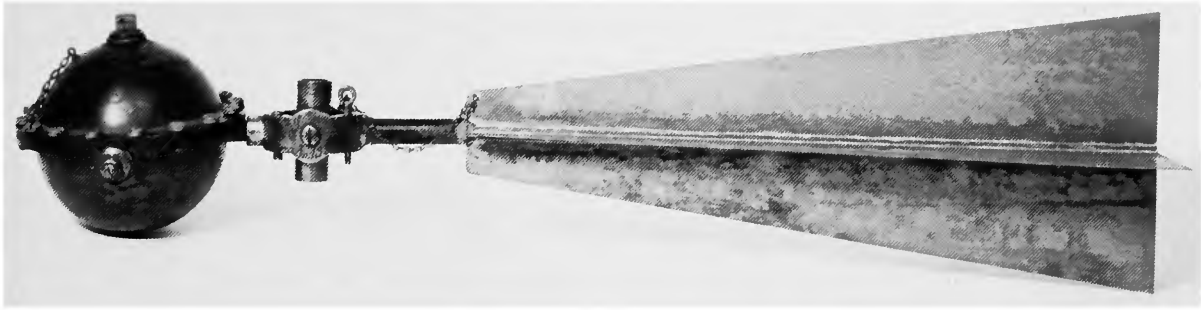

FIGURE 87.—W. G. Price's subsurface direction meter with cover in place, ca. 1886.
(NMHT 316592, Smithsonian photo 72239.)

582,874 dated 18 May 1897; No. 1,413,355 dated 18 April 1922; and No. 1,571,433 dated 2 February 1926.

On 14 January 1885, just before Price applied for the first of those patents, he wrote to the W. & L. E. Gurley firm of Troy, New York, saying in part:

It is a great trouble to me to find a machinist who can make them, and I have been obliged to do all of the fine work myself. I wish you would undertake the manufacture of these instruments and furnish them to the U.S. Government at a reasonable price. . . . Of course, there is not much demand for them just now, as engineers are only just finding out that it is the only accurate way to measure the discharge of rivers. But the engineers on the Mississippi alone are likely to require as many as 3 or 4 every year . . .⁹⁵

Before the end of that year (1885), Price entered into a contract with the Gurley firm to manufacture his current meters on a royalty basis, and took a model of his 32-inch-long meter to them as a sample. While in Troy, a decision was reached for Gurley to manufacture not only one, but two different models. The larger thereof (34 inches long, with a 7½-inch-diameter rotor) was announced in the 26th edition of Gurley's *Manual of the Principle Instruments Used in American Engineering and Surveying* (January, 1886) as their Item No. 375, "Deep Water and Harbor Meter," and the smaller (24 inches long with a 6-inch-diameter rotor) as their Item No. 376, "River and Smaller Stream Meter." At the same time they introduced a Subsurface direction meter of Price's design which registered the compass direction of the velocity in the location at which it was positioned in the water.

Models of these three instruments are shown in Figures 86 to 88. The 34-inch-long model (Figure 86a) had originally been purchased from Gurley's by

the Mississippi River Commission in about 1890. It was used until 1929 by their engineers for measuring the flow of the Mississippi at various points between Rosedale and Vicksburg, Mississippi, and finally trans-

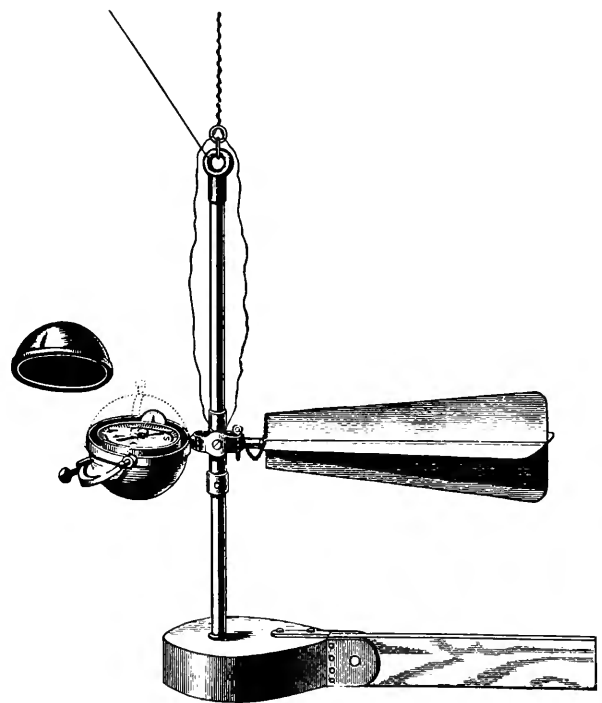

FIGURE 88.—Price's subsurface direction meter assembly with compass cover removed. When observations are made, an electrical current operates a solenoid within the sphere, which locks the position of the compass both vertically and horizontally until a reading is taken. (Courtesy of W. & L. E. Gurley.)

ferred to the Smithsonian in 1939. The shorter model (Figure 86*b*) had been owned and used for many years by the U.S. Geological Survey before being transferred to the Smithsonian in 1916.

Price was probably the Nation's foremost authority on current meters for a longer period than anyone else either before or after his time. Beginning in 1883, just one year after he had invented his first model—and continuing for ten years thereafter—he was in charge of the discharge-measuring operations of the Mississippi River Commission. He conducted many hydraulic studies such as those concerned with the shape of the vertical-velocity curves in rivers, and with the relationship between the velocity of the water at mid-depth as compared with the average velocity in the entire vertical at the same location. His active interest in such subjects continued until the very last days of his life.

On one occasion in 1894, while working on the Missouri River for the Mississippi River Commission, he delivered a speech on irrigation at a conference at O'Niell, Nebraska. Newspaper accounts of that conference described him as an "enthusiastic irrigation-

ist." In response to a need he found in that field, he designed and patented his "Acoustic Current Meter" (Figure 89). That meter received its earliest publicity in an article entitled "A New Current Meter, and a New Method of Rating Current Meters" in the 10 January 1895 issue of *Engineering News*. It too, was manufactured by W. & L. E. Gurley.

The rotor on this meter is smaller (only 5 inches in diameter) and lighter than that on any previous model. The word "acoustic" was used to identify it because of the manner in which sound was conducted from the instrument up to the ear of the operator. While the rotor would be making ten revolutions in the water, a worm gear on the upper end of its axle (which extended to the top of the enlarged chamber on the rod) would cause a lever (in the form of a tiny hammer) to be depressed against a spring. Upon completion of each tenth revolution, the hammer would be released, causing it to swing upwards and strike a metal diaphragm located in the upper end of the chamber. This cycle of operations would then be repeated over and over again as long as the rotor continued to turn. The sound produced each time the



FIGURE 89.—Price's "acoustic current meter," ca. 1895, without brass suspension rods. (NMHT 316594, Smithsonian photo 72243.)

hammer struck the diaphragm would proceed up the inside of the hollow suspension rods to the earpiece worn by the operator, thus enabling him to count, by tens, and to time a certain number of the revolutions with a stopwatch. With the information thus obtained, he could enter a table of corresponding velocity values, and convert it into a figure representing the velocity of the water at the point of observation. These acoustic current meters were quite popular in North America for many years after their introduction.

The last two current-meter patents awarded to Price were never manufactured. They both reflected an opposition he felt toward some of the changes that were being made from his earlier designs, and he had hoped to correct them. About two years after having received his final patent, he left on a trip from his home in Yakima, Washington, to Troy, New York, to confer with members of the W. & L. E. Gurley firm about manufacturing new meters which would contain those latest improvements; but that plan was never consummated. He got only as far east as Detroit, Michigan, when he was seized with a heart attack and taken off the train. He died soon thereafter in Detroit's Fort Shelby Hotel on 6 July 1928, his 75th birthday.

The Geological Survey in the U.S. Department of the Interior became particularly concerned with current meters and stream-gaging methods on two separate occasions. The first was for a short period from 1888 to 1890 when, as previously noted, the U.S. Irrigation Survey became a part of its activities. The second had its beginning in 1894, when Congress started appropriating funds for what is now known as the Water Resources Division of the Geological Survey.

Before 1895, horizontal-axis current meters, such as those of the Haskell type which had been modified by engineers of the Irrigation Survey (Figures 68 and 69), had enjoyed the greatest popularity. In March of that year, however, the University of Nebraska, which owned one of the smaller-sized Price current meters (Gurley's model No. 376 [Figure 86*b*]), lent it to Professor O. V. P. Stout, a per diem employee of the Geological Survey, for making a streamflow measurement. His report to the Survey about its performance was so enthusiastic, that within two months, the Geological Survey acquired one of its own. That occasion marked the beginning of the Survey's preference for meters of the Price type, a preference that is still in vogue. The Geological Survey has perhaps

owned more current meters than any other organization in the world. Well over 95 percent of them have been of the Price type.

The early hydrographers in the Water Resources Division of the Geological Survey soon found it necessary to accommodate themselves to a great variety of measuring conditions while gathering its streamflow data. Streams ranging in discharge from a mere trickle to the flow of the mighty Mississippi fell under their purview. Measurements varied in character from those made while wading the smaller streams to those made from bridges, cableways, boats, and even from ice cover. The instrumentation problems connected therewith were invariably the subject of many discussions at the annual conferences of the Survey's district engineers. Prior to the conference held in Washington, D.C., in 1896, the Chief of the Division, Frederick Haynes Newell (1862-1932), requested that those engineers come prepared to submit suggestions for improving the current meters then in use. Edwin Geary Paul (Figure 90*a,b*), the mechanic of the Division, was instructed to incorporate the most practical thereof in the design of a new meter. His design, and its construction by W. & L. E. Gurley was completed on 12 November 1896 (Figure 90*c*); Paul, assisted by C. C. Babb of the Survey, rated it on 10 December of the same year at the rating station at Chevy Chase Lake, Maryland. This 12-inch-long meter, presently in the Smithsonian's collection made use of the same 5-inch-diameter rotor that had been used on the Price acoustic meters. Its other parts were quite similar to, but considerably lighter than those on the large earlier models, which Gurley had been manufacturing. Because of its unusual method of suspension, there was no necessity for providing a horizontal vane on its tailpiece. It did, however, retain the electric contact facility which characterized all cup-type current meters (other than the Price acoustic models) since the time of Daniel Farand Henry.

This experimental model is the first *Small Price* current meter to have been built. Its lightness, and the ability to disassemble and pack it in a very small space appealed to many of the field hydrographers who often had to carry them and several other items of equipment for long distances on foot. It had been designed for cable suspension only, however, a circumstance that made it necessary for the field men to be supplied with a second meter that was capable of being suspended on a rod. Consequently, the design was soon modified to provide for both rod and cable

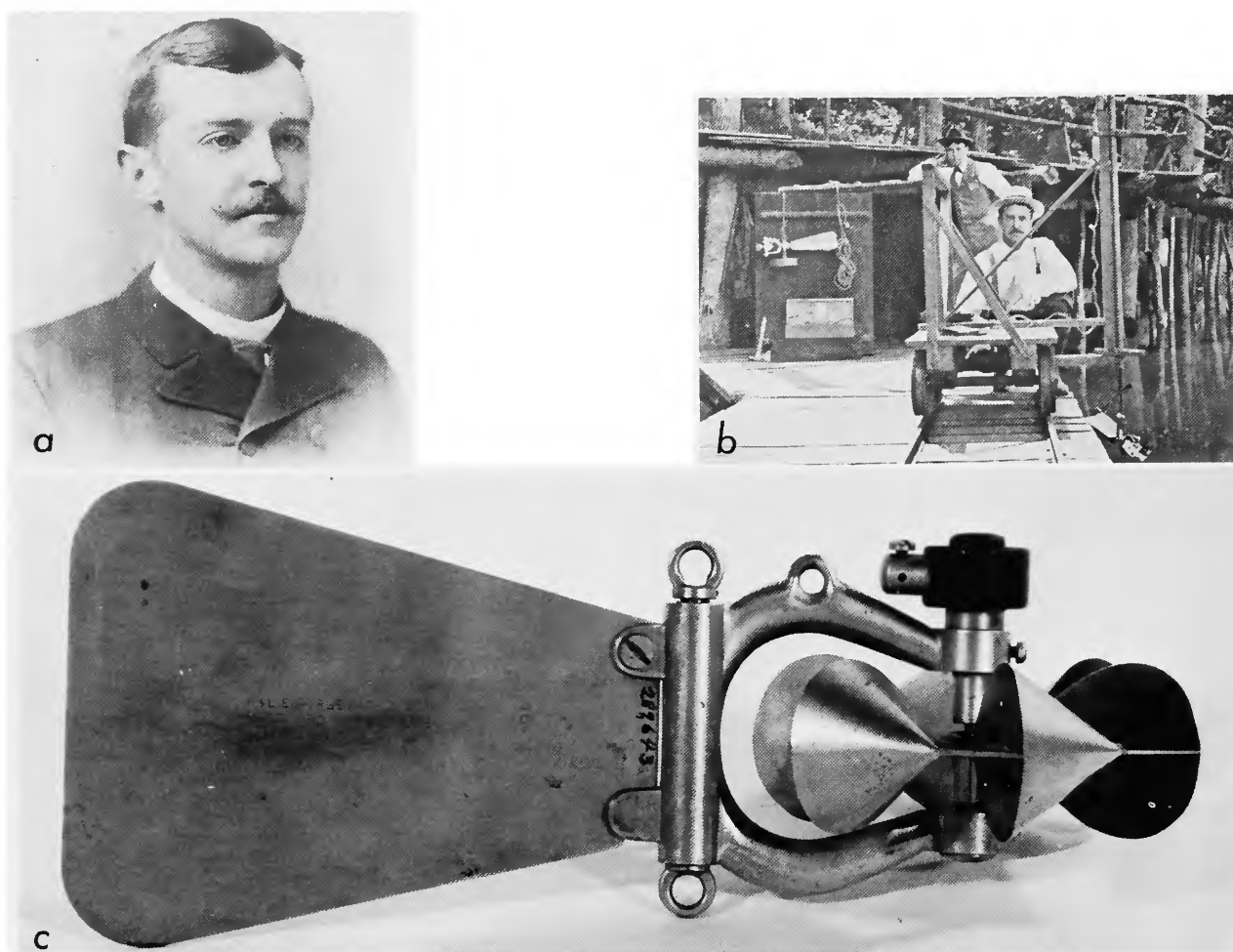

FIGURE 90.—Edwin Geary Paul and his Small Price current meter, 1896: *a*, E. G. Paul, ca. 1900; *b*, Paul, seated behind the U.S.G.S. rating car at Chevy Chase Lake, Maryland, ca. 1896; *c*, original experimental model, built by W. & L. E. Gurley, Troy, New York. (*a*, Courtesy of Mrs. E. G. Paul; *b*, from *U.S.G.S. Water-Supply and Irrigation Paper*, 56, plate 12A; *c*, NMHT 289643, Smithsonian photo 44538-E.)

suspension. The resulting model appears in Figure 91. (The accessory called a “double-end hanger,” which could be installed between the tailpiece and the yoke for accommodating a suspension rod, is not shown in the photograph.) This model met with general approval among the Geological Survey’s field engineers, and the Gurley firm began manufacturing them as a stock item. That firm continued to be the primary manufacturer of such meters until several years after the Price patents had expired.

Because of the many river-gaging stations that the Geological Survey established, its needs for current

meters inevitably kept increasing. A point was finally reached where, to assure a continuing supply of repair parts, it needed to write its own specifications for these instruments. At about the same time, the Survey developed a policy of designing each new innovation in such a way that it could be incorporated in all of their earlier meters by merely replacing an old part with the appropriate modern one, thus up-dating the old models, and saving the expense of purchasing entirely new replacement meters.

The two remaining current meters in the Smithsonian collection, (Figures 92 and 93) reflect that pol-

icy. By about 1908, the meter's yoke was changed to provide a slot through which a thin, flat "hanger" could be passed for suspending the meter and to take the place of the bulky "hanger" shown below the

meter in Figure 91. The new hangers were less expensive, less bulky, and far more streamlined than those earlier models. The improved yoke can be seen on the model shown in Figure 93, although the most



FIGURE 91.—One of the earliest Small Price current meters to be commercially manufactured, ca. 1897, by W. & L. E. Gurley. (NMHT 289644, Smithsonian photo 44538-F.)

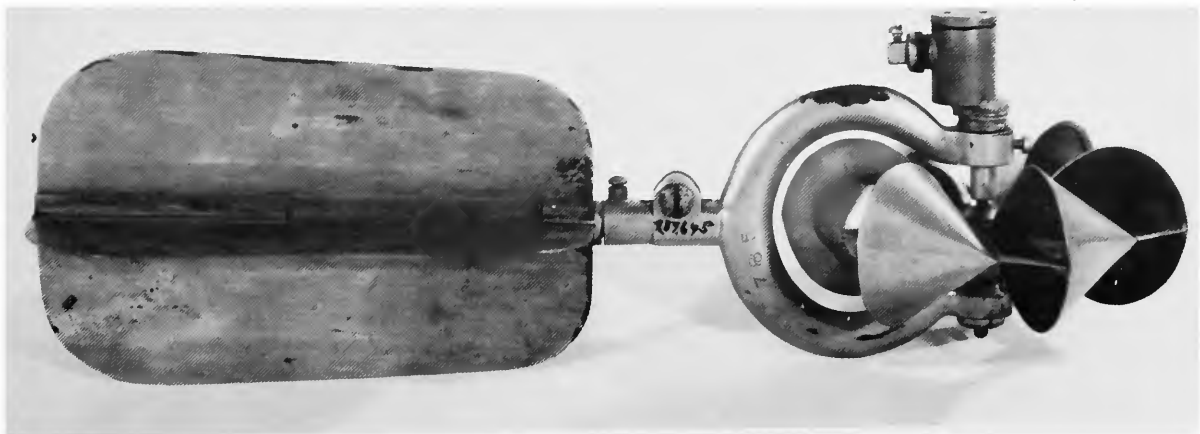

FIGURE 92.—An experimental Small Price current meter, ca. 1908; the first to be furnished with a "penta" contact chamber. (NMHT 289645, Smithsonian photo 44538-B.)

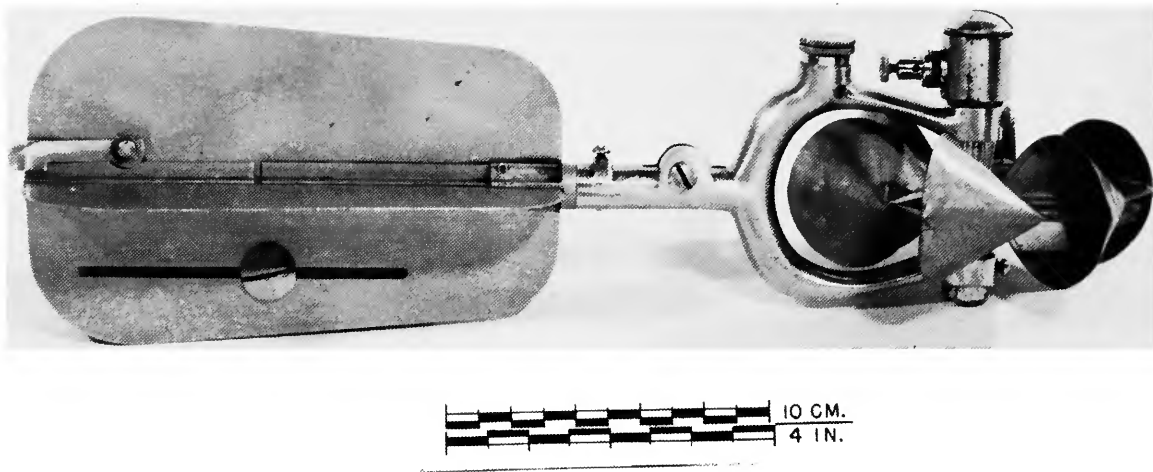

FIGURE 93.—A commercial Small Price current meter with Covert yoke and with one of its two interchangeable contact chambers, ca. 1912. (NMHT 323836, Smithsonian photo 44537-D.)

important feature of that particular meter is the new "penta count" contact chamber on it. On all earlier models of Small Price current meters, the contact facility within such chambers was so designed as to produce just a single electrical contact for every revolution of the rotor. During the period 1906 to 1908, however, John C. Hoyt of the Survey proposed that meters be supplied with an extra contact chamber within which a single contact would be made at each fifth revolution thereof. The idea of a worm-and-gear arrangement was borrowed from the accoustic meters for this purpose.

The meter shown in Figure 93 is the very model which contained the first experimental "penta" contact chamber. Because velocities measured during flood periods would often cause the rotors to revolve too rapidly for the operator to count the revolutions accurately, and because Hoyt's idea could overcome that difficulty in a very satisfactory manner, it was quickly adopted. Another innovation, proposed in 1912 by C. C. Covert, a district engineer of the Geological Survey from New York State, consisted of casting a "boss" on the upper limb of the yoke into which a wading rod might be screwed. Streams in that State, as in all other northern States, are prone to freeze over during the winter months, and before hydrographers could measure them, they had to chop a large number (usually 20 or more) holes through the ice. By suspending the meters in this new manner, the tail-

piece of the meter could be removed, and the size of the holes, together with much of the arduous labor, could be considerably reduced. That idea also met with approval, and the current meter shown in Figure 93 reflects Covert's innovation as well as the commercial version of Hoyt's idea concerning the "penta" contact chambers. The meter shown in this figure is the last of the Small Price meters presently in the Smithsonian collection, a collection which reflects practically all of the improvements in the vertical-axis, cup-type models from their first conception up to those made in 1925. Since then, only a few minor innovations have been added. The pivots on which their rotors have revolved, for example, have since had their lengths changed three times, with the longest of the lot being the present favorite. The only other change consisted of incorporating both the "single contact" and "penta contact" features within a single contact chamber having two electrical binding posts. Since that idea was adopted, hydrographers have needed only to connect the lead wire to whichever terminal best suited their needs. A modern Small Price meter, provided with all of those latest innovations appears in Figure 94.

When undertaking a study of current meters such as this, one cannot help being impressed with the persistence with which each new design tenaciously hangs on throughout the years. Rod floats such as introduced by Leonardo da Vinci, for example, are

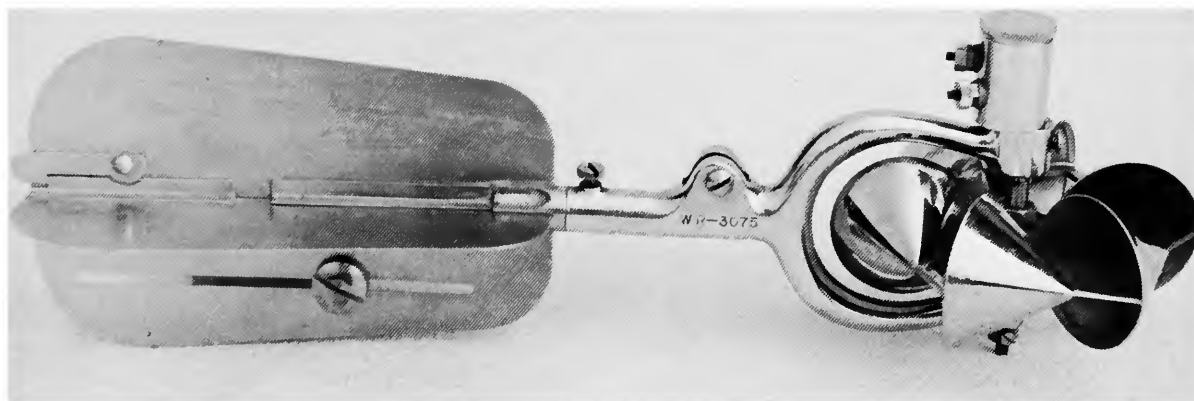

FIGURE 94.—A Small Price current meter of the type now in use.
(Property of the U.S. Geological Survey; photo by A. H. Frazier.)

still being used under certain special conditions, and the same circumstances prevail with respect to practically all of the other instruments discussed here.

In this connection, it should be explained that no attempt has been made to discuss the complete variety of devices that are known to have been used for measuring streamflow. During recent years especially, electromagnetic, electronic, acoustic, optical, photographic, radioactive, chemical, and a host of other methods have been developed, but none of them have yet replaced the conventional, mechanical type of

water current meters, nor have any of them achieved any high degree of popularity. No doubt more than 95 percent of the streamflow measurements throughout the world are presently being made with mechanical current meters, such as the more modern models that have been described here. They are simple in construction, easy to operate, rugged, easy to repair, convenient to transport from one river to another, and are relatively inexpensive. It seems unlikely that they will become obsolete for many years to come.

NOTES

- ¹ SINGER, "From Early Times," page 521.
² FRAZIER, "William Gunn Price."
³ BISWAS, *History of Hydrology*, page 20.
⁴ NOBLECOURT, "Tutankhamun's Golden Trove," page 632.
⁵ GLICK, "Medieval Irrigation Clocks," pages 424-428.
⁶ SCHIAACK, "Vergangenheit, Gegenwart," page 10ff.
⁷ JACOBSEN and LLOYD, *Sennacharib's Aqueduct at Jerwan*.
⁸ HERSCHEL, *Frontinus and the Water Supply*, page 27.
⁹ *Ibid.*, page 202.
¹⁰ COHEN and DRABKIN, *A Source in Greek Science*, page 241. See also Truesdell, "The First Engineer," page 16.
¹¹ FONTANA, *Dell' Accrescimento*, pages [5-6], as translated by the Engineering Societies Library, New York.
¹² *Ibid.*, page [21], as translated by the Engineering Societies Library, New York.
¹³ SALUSBURY, *Mathematical Collections and Translations*, pages 9-12.
¹⁴ GILLISPIE, *Dictionary*, pages 115-116.
¹⁵ POGGENDORFF, *Geschichte der Physik*, page 319.
¹⁶ SALUSBURY, *op. cit.*
¹⁷ DRAKE, *Discoveries and Opinions of Galileo*, page 115.
¹⁸ GILLISPIE, *op. cit.*, pages 115-116.
¹⁹ PARSONS, *Engineers and Engineering*, page 329.
²⁰ WOLF, *History of Science*, page 540.
²¹ GILLISPIE, *op. cit.*
²² SALUSBURY, *op. cit.*
²³ *Ibid.*, page 48.
²⁴ *Ibid.*, page 24.
²⁵ *Ibid.*, page 49.
²⁶ *Ibid.*, page 6.
²⁷ DA VINCI, Manuscript "A" folio 42 v.
²⁸ MARINONI, "Tempo Armonico," pages 45-48.
²⁹ MACCURDY, *The Notebooks of Leonardo da Vinci*, page 526.
³⁰ MASETTI, "Descrizione, Esame e Teoria," page 410.

³¹ HUMPHREYS and ABBOT, *Report Upon the Physics and Hydraulics*," page 225.

³² AGRIPPA, *Nuove Inventioni di Camillo Agrippa*.

³³ ANONYMOUS, "The Life of Monsieur Guglielmini," page 177.

³⁴ GUGLIELMINI, *Opera Omnia*, pages 190-195.

³⁵ SANTORIO, *Commentaria In Primam*, pages 345-346. See also FRAZIER, "Dr. Santorio's Water Current Meter," pages 249-253.

³⁶ BRUNING, *Verhandlingen*.

³⁷ WOLTMAN, *Theorie und Gebrauch*, page 3, table 3.

³⁸ GRANGER, *Vitruvius on Architecture*, pages 323-325.

³⁹ MILANESE, "Dr. Santorio's Water Current Meter," pages 6866-6867.

⁴⁰ MICHELOTTI, *Sperimenti Idraulici*.

⁴¹ ROUSE and INCE, *History of Hydraulics*, page 130.

⁴² BREWSTER, *The Edinburgh Encyclopaedia*, pages 761-762.

⁴³ DUBUAT, *Principes d'Hydraulique*, page 155, as translated by John Macedonia.

⁴⁴ *Ibid.*, page 319.

⁴⁵ BREWSTER, in FERGUSON, *Lectures on Select Subjects*, page 37, plate 1, figure 8.

⁴⁶ MASETTI, *op. cit.*, page 417, as translated by Dr. Carlo Zammattio and A. H. Frazier.

⁴⁷ These tests are more fully described in BEARD's article, "Practical Observations on the Power Expended in Driving the Machinery of a Cotton Manufactory at Lowell."

⁴⁸ Cf. FRIZELL, "The Water-Power of the Falls of St. Anthony," pages 423-424.

⁴⁹ PITOT, "D'une Machine pour mesurer."

⁵⁰ As translated in ROUSE and INCE, *History of Hydraulics*, page 116.

⁵¹ TROSKOLANSKI, *Hydrometry*, pages 425-445.

⁵² PARSHALL, "The Improved Venturi Flume," pages 841-880.

⁵³ TAYLOR, *The Mathematical Practitioners*, page 426.

⁵⁴ USHER, *A History of Mechanical Inventions*, page 324.

⁵⁵ DE SAUMAREZ, "V. An Account of a New Machine," page 411.

⁵⁶ WOLF, *op. cit.*, opposite page 63.

⁵⁷ DE SAUMAREZ, *Account of . . . Henry De Saumarez*, page 4.

⁵⁸ DE SAUMAREZ, "III. A Further Account of a New Machine," "IV. Observations upon the Tides," and "V. An Account of a New Machine."

⁵⁹ SAFFORD and HAMILTON, "The American Mixed-flow Turbine," page 1241, figures 5 and 6.

⁶⁰ DE SAUMAREZ, "III. A Further Account of a New Machine," "IV. Observations upon the Tides," and "V. An

Account of a new Machine."

⁶¹ SMEATON, "LXX. An Account of Some Experiments."

⁶² DE SAUMAREZ, *Account of . . . Henry De Saumarez*.

⁶³ *Ibid.*, page 3.

⁶⁴ SPENCER, "Notes," page 214.

⁶⁵ DE SAUMAREZ, *Account of . . . Henry De Saumarez*, page 8.

⁶⁶ *Ibid.*, page 13.

⁶⁷ *Ibid.*, page 16.

⁶⁸ HOOKE, "A Way-wiser for Sea," pages 84-85.

⁶⁹ FRAZIER, "Joseph Saxton," pages 47-48.

⁷⁰ Saxton diary, Smithsonian Institution Archives, 25 May-23 August 1832.

⁷¹ GREAT BRITAIN, PARLIAMENTARY PAPERS, *Report from the Select Committee*, pages 175-176.

⁷² HASKOLL, *The Practice of Engineering Field Work*, page 261.

⁷³ HUMPHREYS and ABBOT, *op. cit.*, appendix G, pages cxxiv-cxxv.

⁷⁴ The appellation of the "U.S. Coast Survey" was changed by an act of Congress, 20 June 1878, to the "U.S. Coast and Geodetic Survey." See WEBER, *Coast and Geodetic Survey*.

⁷⁵ PAYSON, "Current-Observations," pages 1304-1318.

⁷⁶ HUMPHREYS and ABBOT, *op. cit.*, page 225.

⁷⁷ FRAZIER, "Daniel Farrand Henry," pages 541-565.

⁷⁸ U.S. ARMY CORPS OF ENGINEERS, *Annual Report*, page 621.

⁷⁹ BAUMGARTEN, "Sur le moulinet de Woltman," pages 326-357, and VENTUROLI, *Elementi di Meccanica e Idraulica*, page 160.

⁸⁰ U.S. HOUSE OF REPRESENTATIVES, "Report of Gen. Theodore G. Ellis," pages 304-309.

⁸¹ *Ibid.*, pages 306-307.

⁸² STEARNS, "On the Current Meter."

⁸³ GRUNSKY, "Appendix," page 80.

⁸⁴ *Ibid.*

⁸⁵ HASKELL, "Reminiscences," page 234.

⁸⁶ FRAZIER, "Embudo, New Mexico."

⁸⁷ HOYT and GROVER, *River Discharge*, page 7.

⁸⁸ FRAZIER, "Daniel Farrand Henry," pages 541-565.

⁸⁹ HENRY, *United States International Exhibition, 1876*, page 191.

⁹⁰ U.S. HOUSE OF REPRESENTATIVES, "Appendix A," pages 304-355.

⁹¹ FRAZIER, "William Gunn Price," page 51.

⁹² NETTLETON, *Report of the State Engineer*, page 8.

⁹³ FRAZIER, "William Gunn Price."

⁹⁴ Files of Chief Hydrologist, U.S. Geological Survey, Washington, D.C.

⁹⁵ W. & L.E. Gurley files, Troy, New York.

LITERATURE CITED

ADELAIDE GALLERY. "Description of the Current Meter as Recently Improved by Mr. Saxton." *The Magazine of*

Popular Science (London), volume 1 (May 1836), pages 108-112.

- AGGELER, CECIL. "Design of a Venturi Type Current Meter." Bachelor's thesis, University of California, 1926.
- AGRIPPA, CAMILLO. *Nuove Inventioni di Camillo Agrippa*. Rome: Milanese Presso a Domenico Gigliotti, 1595.
- ANONYMOUS. "The Life of Monsieur Guglielmini." Pages 162-180 in *Memoirs of the Royal Academy of Sciences in Paris Epitomized with the Lives of the Late Members of that Society*. 2nd edition. London: William and John Innys, 1721.
- BAUMGARTEN, A. G. A. "Sur le moulinet de Woltmann destiné à mesurer les vitesses de l'eau, sur son perfectionnement et sur les expériences avec cet instrument." *Annales des Ponts et Chaussées, Mémoires et Documents* (Paris), series 2, semester 2 (1847), pages 326-357.
- BEARD, ITHAMAR A. "Practical Observations on the Power Expended in Driving the Machinery of a Cotton Manufactory at Lowell." *Journal of the Franklin Institute*, January (1833), pages 8-15.
- BISWAS, ASIT K. *History of Hydrology*. Amsterdam-London: North-Holland Publishing Co., 1970.
- BREWSTER, DAVID. *Hydrodynamics*. (Volume 10 of *The Edinburgh Encyclopaedia*, edited by Brewster.) Philadelphia: Joseph and Edward Parker, 1832.
- BRUNING, CHRISTIAAN. *Vehandlingen over de Snelheid van stromend Water* [Discussions on the Velocity of Flowing Water]. Holland, ca. 1789.
- CASTELLI, BENEDETTO. *Della Misura Dell'Acque Correnti*. Bologna: H. H. del Dozza, 1660.
- COHEN, MORRIS R., and I. E. DRABKIN. *A Source in Greek Science*. New York: McGraw-Hill Book Company, Inc., 1948.
- DA VINCI, LEONARDO. Manuscript "A" folio 42 v. Bibliothèque de l'Institut de France, Paris.
- DE SAUMAREZ, HENRY. *Account of the Proceedings of Henry De Saumarez of the Island of Guernsey, Gent*. London, 1717.
- . "V. An Account of a New Machine, Called the Marine Surveyor. . ." *Philosophical Transactions of the Royal Society of London*, volume 33 (Nov.-Dec. 1725), pages 411-432.
- . "III. A Further Account of a New Machine, Called the Marine Surveyor. . ." *Philosophical Transactions of the Royal Society of London*, volume 36 (1729, 1730), pages 45-58.
- . "IV. Observations upon the Tides in the River Thames." *Philosophical Transactions of the Royal Society of London*, volume 34 (1726, Jan.-June 1727), pages 68-76.
- DRAKE, STILLMAN. *Discoveries and Opinions of Galileo*. Garden City, New York: Doubleday & Company, Inc., 1957.
- DUBUAT, M. *Principes d'hydraulique et de pyrodynamique, verifiés par un grand nombre d'expériences faites par ordre du gouvernement*. Volume 1, new edition. Paris, 1816.
- Enciclopedia Italiana di Scienze, Lettere ed Arti*. Rome, 1934-1942.
- FERGUSON, JAMES. *Lectures on Select Subjects in Mechanics, Hydrostatics, Hydraulics, Pneumatics, Optics, Geography, Astronomy and Dialling, by James Ferguson, F.R.S. with Notes and Additional Volume Containing the Most Recent Discoveries in the Arts and Sciences, by David Brewster*. 3rd edition, volume 2. London: Stirling & Slade and Bell & Bradfute, 1823.
- FOCACCI, FRANCESCO. "Per Investigare la Celerita' Dell'acque Correnti." *Memoir di Matematica* (Italian Academy of Sciences), volume 13.
- FONTANA, GIOVAN. *Dell' Accrescimento che hanno fatto li Fiumi, Torrenti, e Fossi che hanno causato l'inondatione à Roma il Natale, 1598*. Rome: Appresso Antonio Marias, Gioiosi, 1640.
- FRAZIER, A. H. "Daniel Farrand Henry's Cup Type 'Telegraphic' River Current Meter." *Technology and Culture*, volume 5, number 4 (fall 1964), pages 541-565.
- . "Embudo, New Mexico, Birthplace of Systematic Stream Gaging." *U.S. Geological Survey Professional Paper*, number 778 (1972).
- . "Dr. Santorio's Water Current Meter, Circa 1610." *Journal of the Hydraulics Division, Proceedings of the American Society of Civil Engineers*, January 1969, pages 249-253.
- . "Joseph Saxton's First Sojourn at Philadelphia, 1818-1831, and His Contributions to the Independence Hall Clock." *The Smithsonian Journal of History*, volume 3 (1968), pages 47-48.
- . "Robert Hooke's Water Current Meter, Circa 1663." *Journal of the Hydraulics Division, Proceedings of the American Society of Civil Engineers*, January 1969, pages 439-443.
- . "William Gunn Price and the Price Current Meters." Paper 70 in *Contributions from the Museum of History and Technology (United States National Museum Bulletin, 252)*. Washington, D.C.: Smithsonian Institution, 1967.
- FRIZELL, JOSEPH P. "The Water-Power of the Falls of St. Anthony." *Transactions of the American Society of Civil Engineers*, volume 12 (1883), pages 412-424.
- GILLISPIE, CHARLES C., editor. *Dictionary of Scientific Biography*. Volume 3. New York: Charles Scribner's Sons, 1972.
- GLICK, THOMAS F. "Medieval Irrigation Clocks." *Technology and Culture*, volume 10, number 3 (July 1969), pages 424-428.
- GRANGER, FRANK, editor and translator. *Vitruvius on Architecture*. Volume 1. New York: G. P. Putnam's Sons, 1934.
- GREAT BRITAIN, PARLIAMENTARY PAPERS. *Report from the Select Committee on Metropolis Water; with Minutes of Evidence, and Appendix, 7 August 1834*.
- GRUNSKY, C. E. "Appendix." In *Report of the Commissioner of Public Works to the Governor of California, 1895*.
- GUGLIELMINI, DOMENICO. [Guglielmini, Dominici]. *Opera Omnia*. Geneva: Cramer, Perachon and Socii, 1719.
- HASKELL, EUGENE E. "Reminiscences." *The Cornell Civil Engineer*, volume 34, number 9 (June 1926), pages 234-235, 272-273.
- HASKOLL, W. DAVIS. *The Practice of Engineering Field Work*. London: Atchley and Co., 1858.
- HENRY, JOSEPH. In *United States International Exhibition 1876*. Volume 7. Washington, D.C.: U.S. Government Printing Office.

- HERSCHEL, CLEMENS. *Frontinus and the Water Supply of the City of Rome*. Boston: Dana Estes and Company, Publishers, 1889.
- HOOKE, ROBERT. "A Way-wiser for Sea." *Register of the Royal Society of London*, volume 6 (1683), pages 84-85.
- HOYT, JOHN C., and NATHAN C. GROVER. *River Discharge*. 4th edition. New York: John Wiley & Sons, Inc., 1927.
- HUGHES, HECTOR J., and ARTHUR J. SAFFORD. *A Treatise on Hydraulics*. New York: Macmillan, 1911.
- HUMPHREYS, A. A., and H. L. ABBOT. *Report upon the Physics and Hydraulics of the Mississippi River*. 2nd edition. Philadelphia: J. B. Lippincott and Co., 1861. [Also published under the same title in 1861 and reprinted in 1876 by the Bureau of Topographical Engineers, War Department as *Professional Papers of the Corps of Topographical Engineers*, number 13(4).]
- JACOBSEN, THORKILD, and SETON LLOYD. "Sennacharib's Aqueduct at Jerwan." *University of Chicago Oriental Institute Publications*, volume 24 (1935), pages 1-52, 36 plates.
- KOLUPAILA, STEPONAS. *Bibliography of Hydrometry*. 1961.
- MACCURDY, EDWARD. *The Notebooks of Leonardo da Vinci*. Volume 1. New York: Reynal and Hitchcock, 1939.
- MARINONI, AUGUSTO. "'Tempo Armonico' O 'Musicale' in Leonardo da Vinci." *Lingua Nostra*, volume 16, fascicle 2 (June 1955), pages 45-48.
- MASETTI, GIOVAMBATISTA. "Descrizione, Esame e Teoria di Tutti i Tachimitri Idraulici." Volume 2 in *Nuova Raccolta D'Autori Italiani, che Trattano del Moto Dell'Acque*. Bologna: Dalla Tipografia di Jacopo Marsigli, 1824.
- MICHELOTTI, FRANCESCO DOMENICO. *Sperimenti Idraulici*. 2 volumes. Turin: Stamperia Reale. [Volume 1, 1767; volume 2, 1771.]
- MILANESE, FERNANDO. "Dr. Santorio's Water Current Meter, Circa 1610 by A. H. Frazier (Discussion)." *Journal of the Hydraulics Division, Proceedings of the American Society of Civil Engineers*, November (1969), pages 6866-6867.
- NETTLETON, EDWIN S. *Report of the State Engineer to the Governor of Colorado for Years 1883 and 1884*. Denver: Collier & Cleaveland Lith. Co., 1885.
- NOBLECOURT, CHRISTIANE DISROCHES. "Tutankhamun's Golden Trove." *National Geographic*, volume 124, number 4 (October 1963), page 632.
- PARSHALL, RALPH LEROY. "The Improved Venturi Flume." *Transactions of the American Society of Civil Engineers*, volume 89 (1926), pages 841-880.
- PARSONS, WILLIAM BARCLAY. *Engineers and Engineering in the Renaissance*. Cambridge, Mass.: M.I.T. Press, 1968.
- PAYSON, A. H. "Current-Observations in San Francisco Harbor, California." Appendix 2 in "Report of the Secretary of War," volume 2, part 2. *House Executive Document 1*, part 2, 45th Congress, 3rd Session (1878).
- PITOT, HENRI DE. "D'Une machine pour mesurer la vitesse des eaux courantes, & le sillage des vaisseaux." Pages 363-373 in *Histoire de l'Academie Royale des Sciences, Année MDCCXXXII, Paris, 1735*.
- POGGENDORFF, JOHANN C. *Geschichte der Physik*. Leipzig, 1879.
- REYVY, JULIEN JOHN. *Hydraulics of Great Rivers: The Parana, the Uruguay, and the La Plata Estuary*. London: E. & F. N. Spon, 1874.
- ROUSE, HUNTER, and SIMON INCE. *History of Hydraulics*. Iowa City: Iowa Institute of Hydraulic Research, State University of Iowa, 1957.
- SAFFORD, ARTHUR T., and EDWARD PIERCE HAMILTON. "The American Mixed-flow Turbine and Its Setting." *Transactions of the American Society of Civil Engineers*, volume 85 (1922), pages 1237-1356.
- SALUSBURY, THOMAS. *Mathematical Collections and Translations The Second Tome*. London: William Leybourne, 1661.
- SANTORIO, SANTORIO. *Commentaria In Primam Fen Primi Libri Canonis Auicennae*. Venice: Apud Marcum Antonium Brogiollum, 1646.
- SCHAACK, MARTIN. "Vergangenheit, Gegenwart und Zukunft der Wasserversorgung" ["Past, Present and Future of Water Supply"]. Hamburg, 1954 [Reprinted from *HWW (Hamburger Wasserwerke)*.]
- SINGER, CHARLES A., and others, editors. "From Early Times to Fall of Ancient Empires." Volume 1 of *A History of Technology*. London: Oxford University Press, 1954.
- SMEATON, JOHN. "LXX, An Account of Some Experiments upon a Machine for Measuring the Way of a Ship at Sea." *Philosophical Transactions of the Royal Society of London*, volume 48, part 2 (1754), pages 532-546.
- SPENCER, HERBERT R. "Notes." *The American Neptune*, volume 14, number 3 (July 1954), page 214.
- STEARNS, FREDERICK P. "On the Current Meter, Together with a Reason Why the Maximum Velocity of the Water Flowing in Open Channels is Below the Surface." *Transactions of the American Society of Civil Engineers*, volume 12 (1883), pages 301-338.
- STORROW, CHARLES S. *A Treatise on Water-Works*. 1835.
- TAYLOR, E. G. R. *The Mathematical Practitioners of Tudor & Stuart England*. Cambridge: The University Press, 1954.
- TOLOTTI, ANTONIO SEMPITERNI. *Rota Idrometra*. Rieti, Italy, 1823.
- TROSKOLANSKI, ADAM T. *Hydrometry: Theory and Practice of Hydraulic Measurements*. Warsaw: Pergamon Press, 1960.
- TRUESDELL, W. A. "The First Engineer." *Journal of the Association of Engineering Societies*, volume 19, number 1 (July 1897), page 16.
- UNITED NATIONS WORLD METEOROLOGICAL ORGANIZATION. "Use of Weirs and Flumes in Stream Gauging." *Technical Note*, number 117 (1971).
- U.S. ARMY CORPS OF ENGINEERS. *Annual Report of the Chief of Engineers to the Secretary of War for the Year 1870*. Washington, D.C.: U.S. Government Printing Office, 1870.
- U.S. GEOLOGICAL SURVEY. *Water-Supply and Irrigation Paper*, number 56, plate 12A.
- USHER, ABBOTT PAYSON. *A History of Mechanical Inventions*. Boston: Beacon Press, 1959.
- U.S. HOUSE OF REPRESENTATIVES. Appendix A in "Report of the Secretary of War," volume 2, part 1 [serial 1844].

- House Executive Document 1*, part 2, 45th Congress, 3rd Session (1878).
- . "Report of Gen. Theodore G. Ellis, Assistant Engineer, Hartford, Conn., March 20, 1875." Appendix AA-14 of the "Annual Report of the Chief of Engineers for the Year 1875," volume 2, part 2 [serial 1676]. *House Executive Document 1*, part 2, 44th Congress, 1st Session (1875).
- VAN WINKEL, FRANKLIN. "Streamflow at a Single Cross Section." *Power and the Engineer*, 10 August 1910.
- VENTURI, GIOVANNI BATTISTA. *Essai sur les ouvrages physico-mathematiques de Leonard de Vinci*. Milan: Vittorio Nugoli & C., 1911. [Originally published 1797.]
- . "Experimental Inquiries Concerning the Principle of the Lateral Communication of Motion in Fluids." Pages 127-184 in Thomas Tredgold, editor, *Tracts on Hydraulics*. Translated by W. Nicholson. London, 1837.
- VENTUROLI, GIUSEPPI. *Elementi di Meccanica e Idraulica*. 1818. [Eight editions published between 1806-1852.]
- VOWLES, HUGH P. "Early Evolution of Power Engineering." *Isis*, volume 17 (1932), pages 412-420.
- WEBER, GUSTAVUS A. *Coast and Geodetic Survey: Its History, Activities, and Organization*. Baltimore: Johns Hopkins Press, 1923.
- WOLF, ABRAHAM. *A History of Science, Technology, and Philosophy in the XVIth and XVIIth Centuries*. 2nd edition. London: George Allen & Unwin Ltd., 1950.
- WOLTMAN, REINHARD. *Theorie und Gebrauch des Hydro-metrischen Flügels*. Hamburg: Benjamin Gottlob Hoffmann, 1790.

Index

- Abbot current meter, 56, 63
 Abbot, Gen. Henry L., 14, 54, 56, 63
 Academy of Sciences, Paris, 25, 43, 57
 Acoustic current meter, 82
 Adelaide Gallery (London), 52, 53
 Adjutage, 4, 33
 Aggeler, Cecil, 39
 Agrippa, Camillo, 15
 Akhenaten (Pharaoh), 2
 Akron (Ohio) Repository, 51
 Alger, Horatio, 51
 American Philosophical Society, 53
 American Society of Civil Engineers, 74
 Anemometer, 20, 50
 Appomattox, 74
 Aqueducts, 4, 6
 Arizona, State of, 77
 Arno River (Italy), 7
 Austrian Institute of Civil Engineers, 50
- Babb, C. C., 83
 Bache, A. D., 53
 Bailey current meter, 78
 Balance scales, 53
 Baldwin, James Fowle, 30
 Baldwin, Loammi, 30
 Barattieri, G. B., 13
 Batchelder, Samuel, 28
 Baumgarten, André Gustave Adolphe, 56-59
 Baumgarten current meter, 56-64, 74
 Beard, Ithamar A., 28-31
 Bentzel, Carl E., 35
 Bentzel velocity tube, 35-36
 Berger, C. L. & Sons, 61
 Bibliography of Hydrometry, 56
 Bi-filar suspension, 51
 Black Friars, Order of, 7
 Black Sea, 24
 Bligh, Captain William, 45
 Bohemia, 69
 Bologna (Italy), 16
 Bors, 20
 Bosphorus, Strait of, 22
 Boston and Lowell Railroad, 30
Bounty, H.M.S., 45
 Brewster, Sir David, 26
 British Association for the Advancement of Science, 26, 50
 British House of Commons, 41
 British National Maritime Museum, 45
 British Parliament, 41
 Brookline (Mass.), 65
 Brooklyn (N.Y.), 30
 Brunacci, Vincenzo, 13
 Brunings, Christiaan, 21
 Buff and Berger, 62-63, 75
 Buff, George Louis, 61
- Cabeo, Nicolà, 13
 California, 63,
 Castelli, Benedetto, 6-8
 Centennial Commission, 74
 Chaseville (N.Y.), 78
 Chevy Chase Lake (Md.) rating station, 83
 Code of Hammurabi, 2
 Codice Atlantico, 9
 Colne River (England), 53
 Colorado Agricultural Experiment Station, 40
 "Colorado" current meter, 77
 Colorado Springs, 76
 Concord River, 28
 Cone, Victor Mann, 40
 Connecticut River, 14, 58, 74
 Conte, 57
 Commissioners of the Admiralty, 47
 Component rotor, 70
 Continuity of flow, 8
 Coradi, G., 68
 Cornell University, 66
 Corps of Engineers, U.S. Army. *See* U.S. Corps
 of Engineers
 Covert, C. C., 86
 Covert yoke, 86
 Croatia, 20
 Cubitt, Joseph, 53
 Cubitt, William, 53
 Cuxhaven (Germany), 50
- Danube River, 24
 Darcy, Henri P.G., 34
 Dark Ages, 5
 Da Vinci, Leonardo, 8-13, 37, 48
 Deane, Zacharia, 75
 Denver (Colo.), 66, 77-78
 Department of the Interior. *See* U.S. Department of
 the Interior
 De Saumarez, Henry, 41-47
 Detroit (Mich.), 64, 83
 Direction-indicating facility, 65, 81
 Double floats, 8. *See also* Floats
 Dubuat, P. L. G., 24-27
 Dummer, John, 28
 Dutch Academy of Sciences, 21
- École des Ponts et Chaussées, 21, 30, 56
 Eddystone lighthouse, 45
 Edinburgh Encyclopaedia, 26
 Egypt, 2
 Elementi di Mechanica e Hydraulica, 56
 Elliott Bros. (London), 50, 53, 68
 Ellis current meter, 74-75, 79
 Ellis, Gen. Theodore G., 14, 58-59
 Embudo (N. Mex.), 66, 78
 England, 30, 50, 68

- Englewood (N.J.), 78
 English channel, 44-45, 50
 E. S. Ritchie and Sons, 65-67
 Estonia, 69
- Ferguson, James, 27
 Floats, 8-17. *See also* Double floats, Free floats, Rod floats
 Florence (Italy), 7
 Florida, State of, 65
 Focacci current meter, 36-37, 72
 Focacci, Francesco, 36
 Fontana, Giovan, 6-7
 Fort Collins (Colo.), 40
 Fort Shelby Hotel, 83
 Fossombroni, Vittorio, 36
 Fourcroy, de, 25
 France, 24
 Francis, James, 14, 31, 61-63
 Franklin Institute (Philadelphia, Pa.), 51, 75
 Frederick (Md.), 51
 Free floats, 8-14. *See also* Floats
 Frontinus, 4, 6-7
 Fteley, Alphonse, 59-61
 Fteley-Stearns current meter, 59-61, 77
- Gaging stations, 1
 Galileo, 6-8, 16
 Garonne River (France), 56, 58
 Gauthey, Edmund Marie, 21
 Geological Survey. *See* U.S. Geological Survey
 Germany, 68-70
 Ghadames (Oasis), 3
 Golden Gate Park (San Francisco), 63
 Great Exhibition (London), 53
 Great Lakes, 56, 73-74
 Greeley, Horace, 75
 Grover, Nathan C., 78
 Guernsey, Island of, 41
 Guglielmini, Domenico, 15-17, 24
 Gulf Stream, 65
 Gurley, W. & L. E., 81-85
- Hall current meter, 78
 Hall, William Hammond, 63-64, 67, 78
 Halley, Edmund, 46
 Hamilton canal, 28, 31
 Hamilton mills, 28, 29
 Hammurabi, 2
 Harlacher, Andreas R., 69
 Harlacher current meter, 69
 Hartford (Conn.), 74
 Haskell current meter, 78, 83
 Haskell, Eugene E., 64-67, 78
 Haskoll, W. Davis, 53
 Henry current meter, 56, 58, 73-75
 Henry, Daniel Farrand, 56, 58, 73-75, 83
 Henry, Joseph, 74
 Hero of Alexandria, 4-5, 29
 Herschel, Clemens, 37, 58, 61-62, 74, 78
 Herschel current meter, 78
 Hooke current meter, 48-50, 72
- Hoover Dam, 77
 Horizontal-axis meters, 48-71
 House of Commons, 41
 Hoyt, John C., 86
 Humphreys, A. A., 14, 54, 58, 73
 Humphreys and Abbot Report, 73-74
 Hyde Park (London), 45
 Hydroelectric power, 1
 Hydrometry, 16, 36
- Independence Hall, 52
 Integration method, 50-51
 International Boundary and Water Commission, 21
 Irrigation, 1
 Irrigation Survey. *See* U.S. Irrigation Survey
 Italian Royal Academy of Sciences, 16, 36
- Jerwan (Iraq), 4
- Keeler, Karl Fairbanks, 20-21
 Kempton (Germany), 68
 Knoxville (Pa.), 78
 Kolupaila, Steponas, 56, 69-71
- Lake Mead (Nevada), 77
 Lake Trasimeno (Italy), 7
 Lallie and Bailey, 78
 Lallie, J. S. J., 78
 La Plata estuary, 50
 Large Price current meters, 81-82
 Leach, Captain Smith H., 78-79
 Leonardo da Vinci. *See* Da Vinci, Leonardo
 Lerebours et Secretan (Paris), 57-58, 68
 Lerebours, Marc, 58, 74
 Leupold and Stevens, Inc., 21, 35
 Lithuania Hydrometric Bureau, 69
 Litigations, 1
 Log line, 47
 Logs. *See* Ships' logs
 London, 41, 50, 52-53, 68
 Longitude, 41
 Lords Commissioners of the Admiralty, 47
 Louis XIV, 43
 Lowell (Mass.), 14, 28-32, 60-62
 Lowell Courier, 29
 Lukens, Isaiah, 52
- Magazine of Popular Science*, 53
 Manitou (Colo.), 76
 Marine surveyors, 41, 45
 Marinoni, Augusto, 8
 Mariotte, Edme, 13, 41
 Marmora, Sea of, 24
 Marsili, Luigi Ferdinando, 22-24
 Martin, John, 53
 Mead, Ellwood, 77
 Merrimack River, 28
 Michelotti, Francesco Domenico, 24
 Milan (Italy), 24, 68
 Milanese, Ferdinando, 24
 Military Academy (U.S.), 30

- Mississippi River, 14, 21, 64-65, 78-81
 Mississippi River Commission, 64-65, 78-82
 Missouri River, 78, 82
 Mitchell, Henry, 65
 Monte Casino Monastery, 7
 Moore, Benjamin Theophilus, 68
 Moore's current meter, 67-68
 Munich (Germany), 68
- National Academy of Sciences, 53
 National Bureau of Standards, 53
 National Museum of History and Technology, 1
 Navy Department. *See* U.S. Navy Department
 Nesselwang (Bavaria), 68
 Nettleton, Edwin S., 75-78
 Newell, Frederick Haynes, 83
 Newton, Sir Isaac, 41, 47
 New York harbor, 65
 Nicholas, Czar of Russia, 30
- Oases, 3
 Odometer, 8
 Office of Weights and Measures, 53-54
 Ohio River, 78
 O'Neill (Nebr.), 82
 Orifices, 11, 33
 Ott, A., firm of, 68-69
 Ott, Albert, 69
 Ott current meters, 68-71
 Ott, Herman, 69
 Ott, Ludwig, 69
- Paddles, 16-21
 Paddle wheels, 21-32
 Padua (Italy), 16
 Paducah (Ky.), 78-79
 Parana River, 50
 Parshall, Ralph Leroy, 40
 Parsons, Dr., 30
 Parsons, William Barclay, 7
 Patent Office (Great Britain), 47
 Patterson, R. M., 53
 Paul, Edwin Geary, 83-84
 Payson, Lt. A. H., 55-56
 Peale, Franklin, 53
 "Penta" contact chamber, 86
 Perkins, Jacob, 53
 Persian windmill, 72, 73
 Perugia (Italy), 6-7
 Philadelphia (Pa.), 51-53, 74
 Philadelphia Mint, 53
 Pisa (Italy), 7
 Pitot, Henri de, 34
 Pitot tube, 24, 33-34, 37
 Pogendorf, 7
 Point Pleasant (Mo.), 65
 Poleni, Marquis Giovanni, 37
 Poncelot, Jean Victor, 57
 Ponts et Chaussées. *See* École des Pontes et Chaussées
 Pope Urban VIII, 7
 Powell, John Wesley, 66
- Price acoustic current meter, 82-83
 Price current meters, 75, 78-87
 Price, William Gunn, 75, 78-87
 Prismatic Club, 73
 Proprietors of Locks and Canals, 28, 31, 54, 56, 60-61, 63
- Q = A, 4, 6-8
 Q = AV, 5, 8
 Quadrant and ball, 15-17, 24
 Quinaria, 4, 33
- Rating of current meters, 50, 53
 Reynolds, Gen. William F., 56, 73-74
 Renaissance, 8
 Repository (Akron, Ohio), 51
 Révy current meter, 50-51, 68
 Révy, Julien John, 50-51
 Riefler, Clemens, 68
 Rio Grande, 66
 Ritchie, E. S., 65
 Ritchie, E. S. and Sons, 66-67
 Ritchie-Haskell direction current meter, 66
 Robinson anemometer, 73
 Rod float, 8-11, 13-14. *See also* Floats
 Rohwer, Carl, 40
 Roman aqueducts, 4, 6-7, 33
 Rome, 6-7
 Rosedale (Miss.), 81
 Rouse, Hunter, 24, 34
 Royal Institution (London), 53
 Royal Society of Edinburgh, 26
 Royal Society of France, 34, 43
 Royal Society of London, 26, 43, 45-48
 Russia, 30
- Safford, Arthur T., 43, 60-61
 Saint James Park (London), 41
 Saint Petersburg (Russia), 30
 Salusbury, Thomas, 6
 San Francisco, 56, 63-64
 Santorio, Santorio, 16, 20-21
 Saxton current meter, 17, 53-56, 63, 68
 Saxton, Joseph, 51-56
 Schaak, Martin, 3
 Schenevus (N.Y.), 78
 Scott, W. E. and Co., 77
 Secretan (Paris), 56
 Sellers, Coleman, 53
 Sennacherib, 4
 Serviss, J. H., 78
 Sexton, George, 51
 Ships' logs, 14-15, 41-49, 68
 Small Price current meters, 67, 83-87
 Smeaton, John, 45
 Smithsonian Institution, iii-iv, 26, 45, 50, 54, 56, 61, 63-64, 68, 73-74, 78-79, 82-83, 86
 South America, 50
 "Square inch" method, 33
 S-rotor, 37
 Standards (U.S.), 53

- Stearns, Frederick P., 59-61
 Stephenson steam locomotives, 30
 Stimson, Eugene K., 76
 Storrow, Charles S., 30-32
 Stout, Prof. O. V. P., 83
 Subsurface direction meter, 81
 Sudbury River, 59-60
 Survey of the Northern and Northwestern Lakes, 6-1
 Sussex Street (London), 53
- Technology and Culture, 73
 Tel 'Armarna (Egypt), 2
 Tethered floats, 8. *See also* Floats
 Thames estuary, 43-44, 47
 Thames River (England), 68
 Tiber River (Italy), 6, 56
 Tolotti, Antonio Sempiterni, 72
 Tolotti current meter, 72-73
 Trasimeno Lake (Perugia, Italy), 7
 Tredgold, Thomas, 37
 Trieste (Italy), 20
 Trinity House (London), 47
 Trowbridge, Prof. William P., 54
 Troy (N.Y.), 81, 83
 Tubing applications, 33-40
 Tutankhamun (Pharaoh), 2
 Turin (Italy), 24
- Union Colony, 76
 United Nations, 40
 University College (London), 53
 University of Nebraska, 83
 University of Notre Dame, 70
 Uruguay River, 50
 U. S. Army, 58
 U. S. Coast and Geodetic Survey, 50, 65
 U. S. Coast Survey, 53-54
 U. S. Corps of Engineers, 58, 63-64, 74-75, 78
 U. S. Department of Agriculture, 40
 U. S. Department of the Interior, 66, 83
 U. S. Geological Survey, 1, 50, 64, 66-67, 69, 78, 82-83
 U. S. International Exhibition, 1876, 74
 U. S. Irrigation Survey, 64, 66-67, 78, 83
 U. S. Lake Survey, 56, 58, 64, 73, 75
- U. S. Mint, 53
 U. S. Navy Department, 66, 78
 U. S. Waterways Experiment Station, 35
- Velocity distribution, 8-11
 Venice (Italy), 16
 Venturi flumes, 40
 Venturi, Giovanni Battista, 11, 37-39
 Venturi tubes, 37-40
 Venturoli, Giuseppe, 56
 Vertical-axis meters, 72-87
 Vertical velocity curve, 16-17, 36
 Vicksburg (Miss.), 81
 Vienna (Austria), 68
 Vitruvius, 4, 22
 Vowles, Hugh F., 73
- Warren, General G. K., 74
 Washington, State of, 83
 Washington, D. C., 53, 83
 Water masters, 1
 Water Resources Branch, 67, 69, 83
 Watkins and Hill (London), 53
 Way-wiser for sea, 48
 Weirs, 40
 Western Canal (Lowell, Mass.), 31
 Westfield (Mass.), 51
 Wheatstone Bridge, 53
 Wheatstone, Charles, 53
 Whistler, George Washington, 29-32
 Windsor (Conn.), 51
 Wolf, Abraham, 7, 13
 Woltman current meter, 68
 Woltman, Reinhard, 21, 49-50
 World Meteorological Organization, 40
- Ximenes, Leonardo, 21
- Yakima (Wash.), 83
 Yoke, Covert. *See* Covert yoke
 Yugoslavia, 20
- Zammattio, Carlo, 8, 20
 Zurich (Switzerland), 68

