

Host-specificity and coevolution among pollinating and nonpollinating New World fig wasps

WENDY A. MARUSSICH and CARLOS A. MACHADO

Department of Ecology and Evolutionary Biology, University of Arizona, Tucson, AZ 85721-0088, USA

Abstract

Figs (*Ficus* spp., Moraceae) and their pollinating wasps (Hymenoptera, Agaonidae, Chalcidoidea) constitute a classic example of an obligate plant-pollinator mutualism, and have become an ideal system for addressing questions on coevolution, speciation, and the maintenance of mutualisms. In addition to pollinating wasps, figs host several types of nonpollinating, parasitic wasps from a diverse array of Chalcid subfamilies with varied natural histories and ecological strategies (e.g. competitors, galls, and parasitoids). Although a few recent studies have addressed the question of codivergence between specific genera of pollinating and nonpollinating fig wasps, no study has addressed the history of divergence of a fig wasp community comprised of multiple genera of wasps associated with a large number of sympatric fig hosts. Here, we conduct phylogenetic analyses of mitochondrial DNA sequences (COI) using 411 individuals from 69 pollinating and nonpollinating fig wasp species to assess relationships within and between five genera of fig wasps (*Pegoscapus*, *Idarnes*, *Heterandrium*, *Aepocerus*, *Physothorax*) associated with 17 species of New World *Urostigma* figs from section *Americana*. We show that host-switching and multiple wasp species per host are ubiquitous across Neotropical nonpollinating wasp genera. In spite of these findings, cophylogenetic analyses (TREEMAP 1.0, TREEMAP 2.02 β , and PARAFIT) reveal evidence of codivergence among fig wasps from different ecological guilds. Our findings further challenge the classical notion of strict-sense coevolution between figs and their associated wasps, and mirror conclusions from detailed molecular studies of other mutualisms that have revealed common patterns of diffuse coevolution and asymmetric specialization among the participants.

Keywords: Agaonidae, coevolution, cophylogeny, *Ficus*, host-specificity, host-switching

Received 20 August 2006; revision received 21 November 2006; accepted 8 January 2007

Introduction

Figs (*Ficus* spp., Moraceae) and their pollinating wasps (Hymenoptera, Agaonidae, Chalcidoidea) are a classic example of an obligate mutualism and an ideal system for addressing questions on coevolution, speciation, and the maintenance of mutualisms. Both the figs and their pollinating wasps are completely dependent on each other for survival and reproduction, as figs can only be pollinated by fig wasps, and fig wasps can only reproduce within figs. A fig is a unique inflorescence consisting of a hollow sphere lined with hundreds of tiny flowers (i.e. the syconium).

One or more female pollinator wasps (i.e. foundresses) enter the fig through a small pore (i.e. the ostiole) and pollinate the flowers, laying eggs in some of them, and then die inside the fig. Pollinator wasp larvae develop in galls within the flowers, each consuming the contents of one would-be seed. Adult pollinator offspring then mate within the syconium and the females fly to another fig to oviposit and pollinate. Unlike the females, male pollinator wasps are wingless, and have highly specialized mouth parts for chewing females out of their galls, fighting with other males, and, most importantly, for chewing an exit tunnel for the female wasps to leave the syconium (Cook *et al.* 1997; Zammit & Schwarz 2000; Greeff *et al.* 2003).

Traditionally, it was thought that each fig species had its own species-specific pollinator wasp species, and the fig-fig wasp mutualism was often used as a classic example

Correspondence: Dr Wendy A. Marussich, Fax: 520-621-9190; E-mail: wmarussich@gmail.com

of diversification through strict-sense or one-to-one coevolution (Ramirez 1970; Wiebes 1979; Bronstein 1987; Herre *et al.* 1996; Anstett *et al.* 1997). However, recent surveys using genetic markers instead of morphology, have revealed multiple pollinator species co-occurring on the same fig species, often in up to 60% of the fig species studied (Kerdelhue *et al.* 1999; Molbo *et al.* 2003; Molbo *et al.* 2004; Haine *et al.* 2006). A detailed study of Neotropical pollinators showed that some of the co-occurring pollinators represent instances of past host switches, as the pollinator lineages are not sister species, whereas others represent pollinator lineages that diverged on the same host fig (Molbo *et al.* 2003). Further, it was shown that several pollinator species are associated with multiple fig hosts, suggesting the occurrence of introgression among different fig species. In fact, introgression and hybridization have been demonstrated in figs from two different continents (Parrish *et al.* 2003; Machado *et al.* 2005), providing support to previous observations of hybrid fig phenotypes in nature (Condit 1950; Ware & Compton 1992; Ramirez 1994).

These findings suggest that pollinator host-switching may be a more common phenomenon than previously thought in this mutualism (Machado *et al.* 2005), bringing into question the assumption of strict-sense, one-to-one, coevolution. Nonetheless, there should be some constraints on rampant host-switching by pollinating wasps due to some important characteristics of the fig. First, zero or low pollination success due to genetic incompatibilities among fig species will most likely lead to fruit abortion, and thus represents a dead end for the wasp. Second, if there are no genetic incompatibilities between hosts, then physiological conditions required by the wasp (e.g. temperature, development time; see Patiño *et al.* 1994) may play an important role in determining whether a host-switch is successful. Finally, morphological constraints (e.g. fig size, style length, ostiole diameter) and ecological constraints (e.g. the presence of other wasp species) may preclude successful production of seeds or wasps (Herre 1989; vanNoort & Compton 1996).

In addition to pollinating wasps, figs host a diverse array of nonpollinating wasps that obligately rely on figs for their development and reproduction without providing any known benefit to their hosts (Bronstein 1991; Compton & Hawkins 1992; Boucek 1993; West & Herre 1994; West *et al.* 1996; Cook & Rasplus 2003; Pereira & do Prado 2005). All fig wasp pollinators and most nonpollinators are currently classified as being part of the same Chalcid family, Agaonidae, and sort into six different subfamilies (Agaoninae, Epichrysomallinae, Sycophaginae, Sycoecinae, Otitesellinae, and Sycoryctinae; Boucek, 1988; Boucek 1993). However, recent molecular studies have shown that the Agaonidae, as defined by Boucek, is paraphyletic (Machado 1998; Rasplus *et al.* 1998). Three of the constituent subfamilies of nonpollinating fig wasps (Sycoecinae, Otitesellinae and Sycoryctinae) were reassigned to family

Pteromalidae, and the pollinating fig wasps were left in their own family, Agaonidae (Rasplus *et al.* 1998; Campbell *et al.* 2000). The taxonomic affinities of subfamilies Sycophaginae and Epichrysomallinae remain unclear, but it is apparent that they do not belong in the Agaonidae (J. Y. Rasplus, S. vanNoort, personal communication).

Few phylogenetic studies have been conducted on non-pollinating fig wasps, either at coarse or fine taxonomic scales (Machado *et al.* 1996; Machado 1998; Rasplus *et al.* 1998; Lopez-Vaamonde *et al.* 2001; Weiblen & Bush 2002; Jousselin *et al.* 2004; Jousselin *et al.* 2006). For instance, phylogenies of New World nonpollinating wasps are generally sparse (Machado *et al.* 1996), and most New World nonpollinating wasps are not described below the genus level (Gordh 1975; Boucek 1988; Boucek 1993). The three most common New World nonpollinating wasp genera associated with one of the two endemic Neotropical fig sections, *Urostigma Americana*, are *Idarnes* Walker (subfamily Sycophaginae), *Heterandrium* Mayr (Pteromalidae, subfamily Otitesellinae), and *Aepocerus* Mayr (Pteromalidae, subfamily Otitesellinae). *Idarnes* are further split in two distinct groups, *Idarnes 'sensu stricto'* and *Idarnes 'incerta'* (Boucek 1993; West *et al.* 1996; Bernhard *et al.* submitted). In addition, wasps from a fourth genus, *Physothorax* Mayr, are also commonly observed in *Urostigma Americana* figs. *Physothorax* wasps, which belong to Chalcid family Torymidae, are parasitoids and do not use fig tissue for their development (Boucek 1988; Boucek 1993).

New World nonpollinating fig wasps from *Urostigma Americana* figs comprise three ecological types: competitors, gallers, and parasitoids. Unlike all pollinating fig wasps and some Old World nonpollinating wasps which enter the syconium to oviposit (Newton & Lomo 1979; Ramirez & Malavasi 1997; Kerdelhue *et al.* 2000; Jousselin *et al.* 2001), New World nonpollinating wasps oviposit from the outside of the fig, and thus do not disperse pollen. Competitor wasps (e.g. *Idarnes 'sensu stricto'*) are generally similar in body size to the pollinating wasps with which they co-occur; however, they have ovipositors several times longer than their bodies that they use to reach through the wall of the fig in order to oviposit directly into fig inflorescences (Gordh 1975; Boucek 1988; Bronstein 1991; Boucek 1993; West & Herre 1994; Bernhard *et al.* submitted). They are referred to as competitors because they appear to compete with the pollinating wasps for oviposition sites (West & Herre 1994; West *et al.* 1996; Pereira & do Prado 2005). Competitor wasps are the most common nonpollinating wasps in the Neotropics, and are often found in 100% of figs examined from a single crop (West *et al.* 1996; W. A. Marussich and C. A. Machado, personal observations). Galler wasps (e.g. *Idarnes 'incerta'*, *Heterandrium*, and *Aepocerus*) are usually much larger than pollinator or competitor wasps, and occur less frequently. They do not lay their eggs in fig inflorescences; instead, they oviposit directly into the fig wall, producing large galls that protrude into

the centre of the fruit (Bronstein 1991; West *et al.* 1996). Figs containing galler wasps have reduced pollinator and seed production, most likely due to the drain of fig resources necessary to produce such large galls (West *et al.* 1996). Parasitoid wasps found in *Urostigma Americana* figs (e.g. *Physothorax*) constitute the least common of the three main types of New World nonpollinating fig wasps. They have long ovipositors, similar to those of the competitor wasps, which they use to lay eggs in *Aepocerus* galls through the wall of the fig (West *et al.* 1996).

Some nonpollinating wasps do not require the presence of pollinating wasps to successfully develop in a fig host. For instance, several galler wasps (e.g. *Aepocerus*, *Heterandrium*) can override the abortion of unpollinated or under-pollinated figs (Bronstein 1991; West *et al.* 1996; W. A. Marussich, personal observation), and the males of several species such as *Idarnes* (Bronstein 1991), *Aepocerus* (West *et al.* 1996), and *Heterandrium* (W. A. Marussich, personal observation) may be capable of tunneling through the wall of the fig to create an exit hole. The lack of dependence of some groups of nonpollinators on pollinating wasps to complete their life cycle, suggests that host-specificity may be less constrained in nonpollinators than in pollinators. Nonetheless, some degree of host-specificity is still expected in nonpollinators because important morphological, ecological, and chemical constraints could reduce the likelihood of host switches. First, the nonpollinating wasp requires reproductive synchrony with fig development time; this is especially critical for competitor wasps that use seed tissue. Second, characteristics of ovipositor length and strength may not allow certain nonpollinator species to exploit fig species whose syconia walls are either too thick or too hard for sufficient penetration of the ovipositor. Third, there are expected constraints on the recognition of chemical cues (volatiles) used by fig wasps to find receptive hosts (Grison-Pige *et al.* 2002); nonpollinators should be able to recognize only those hosts with similar volatile profiles. Fourth, the presence of other wasps such as competitors and parasitoids already associated with a given fig species may constrain the possibility of host-switches by niche exclusion. Any mismatches between the wasp and the fig in those four aspects will either have negative fitness consequences for the nonpollinator or will not allow host recognition, and thus will constrain the likelihood of host-switching.

Coevolutionary studies involving fig wasps have generally focused on comparisons of the phylogenies of figs and their pollinating wasps (Herre *et al.* 1996; Machado *et al.* 1996; Weiblen 2000; Machado *et al.* 2001; Weiblen 2001; Joussetin *et al.* 2003; Yokoyama 2003; Jackson 2004; Machado *et al.* 2005; Joussetin *et al.* 2006), although nonpollinators from several geographical regions have been recently studied using cophylogenetic approaches (Machado *et al.* 1996; Lopez-Vaamonde *et al.* 2001; Weiblen & Bush 2002; Jackson

2004; Joussetin *et al.* 2004; Joussetin *et al.* 2006). Nonetheless, phylogenies of nonpollinating wasps are scarce, and most New World nonpollinating wasps are still not described below the genus level (Gordh 1975; Boucek 1988; Boucek 1993).

Here we present the largest molecular phylogenetic survey of nonpollinators to date, focusing on the six most common nonpollinating wasps associated with 17 New World *Urostigma Americana* fig species. First, we sort both the pollinating and nonpollinating wasps into 69 genetically distinguishable 'molecular species' comprised of individuals with DNA sequences of a common DNA barcoding marker (COI) that form clearly distinct and highly supported monophyletic clades. Then, we separate these species by the fig host from which they were collected to test levels of host-specificity and multiple co-occurring species, and compare their phylogenies with those of interacting wasps to determine differences in the level of host-switching among the various wasp genera. We also use several methods originally developed for coevolutionary analyses of hosts and parasites (i.e. TREEMAP 1.0, TREEMAP 2.02 β , and PARAFIT) to look for evidence of cospeciation between pollinating and nonpollinating wasps, and to test whether there are any patterns of coevolution among different wasp types based on their life history traits and the fig hosts upon which they occur.

We predict that pollinating wasps should show higher levels of host-specificity than nonpollinators because the consequences of host-switching by pollinators are more likely to be detrimental for both partners in the mutualism than host-switching by nonpollinators. Although we expect to see less species-specificity in nonpollinating wasps due to the uncoupling of their fitness from that of their hosts, we still expect some degree of host-specificity due to morphological, ecological, and chemical constraints on the nonpollinators. We also expect strong phylogenetic congruence between pollinators and competitors and between galls and their parasitoids due to their tight ecological relationships. Further, we expect to observe some degree of congruence in the phylogenies of competitors and galls, because galls are able to override abortion of unpollinated figs to which competitors may in turn have access (some competitors may be able to utilize unpollinated fig syconia, however, it is not clear whether this capacity is general across all competitor species; Bronstein 1991; West *et al.* 1996; W.A. Marussich & C.A. Machado, personal observations). Finally, we predict that levels of phylogenetic congruence should be weak between pollinators and parasitoids, and competitors and parasitoids, because they do not have direct ecological interactions.

Materials and methods

Figs were collected from 14 species of New World strangler figs (subgenus *Urostigma*, section *Americana*), in the vicinity

of the Panama Canal, Republic of Panama, between February 1997 and May 2005. Figs were also collected from one species in Florida, USA, one species in Costa Rica, and one species growing on the University of Arizona campus, for a total of 17 fig species. Ripe figs were collected from the trees, returned to the laboratory, cut in half, and placed in Petri dishes to allow the wasps to emerge. Upon emergence, all wasps were sorted into genus, or species-group in the case of *Idarnes*, using simple morphological differences (as described by Gordh 1975; Boucek 1988; Boucek 1993), and stored in ethanol at -20°C for DNA analyses. A total of 411 individuals were included in the present analyses (Table 1).

Wasp biology and classification

New World strangler figs (subgenus *Urostigma*, section *Americana*) are pollinated by wasps from the genus *Pegoscapus* (Agaonidae). *Pegoscapus* wasps have winged females and wingless males. One or more female pollinator wasps (i.e. foundresses) enter the fig through a small pore (i.e. the ostiole) and pollinate the flowers, laying eggs in some of them, and then die inside the syconium. Pollinator wasp larvae develop in galls inside the flowers, consuming the contents of one would-be seed. Mating takes place inside the fig, and then the males chew a tunnel through the wall of the fig allowing females to exit and repeat the cycle. In addition to the pollinator wasps, *Urostigma Americana* figs also host multiple nonpollinating wasps. The four most common Neotropical nonpollinating wasp genera, *Idarnes* Walker (subfamily Sycophaginae), *Heterandrium* Mayr (Pteromalidae, subfamily Otitesellinae), *Aepocerus* Mayr (Pteromalidae, subfamily Otitesellinae), and *Physothorax* Mayr (Torymidae) (Boucek 1988; Boucek 1993), are the focus of our study.

Competitor wasps belong to the genus *Idarnes* (subfamily Sycophaginae), which is comprised of three species-groups: *flavicollis*, *carne*, and *incerta* (Gordh 1975; Boucek 1988; Boucek 1993; West *et al.* 1996; Bernhard *et al.* submitted). *Idarnes 'flavicollis'* and *I. 'carne'* are ecologically and morphologically similar, and both use their long ovipositors to oviposit directly into fig inflorescences from the exterior of the fig. As *Idarnes 'flavicollis'* and *I. 'carne'* larvae consume the contents of one would-be seed, they compete directly with pollinators for seeds, and are thus considered direct competitors of the pollinators (West & Herre 1994; West *et al.* 1996; Herre & West 1997; Pereira & do Prado 2005). In addition, *I. 'flavicollis'* and *I. 'carne'* have flightless males that may be capable of tunneling through the wall of the fig to create an exit (Bronstein 1991). *Idarnes 'incerta'*, on the other hand, is morphologically and ecologically distinct from the other two types of *Idarnes* (Boucek 1988; Boucek 1993). *Idarnes 'incerta'* has females with shorter, thicker ovipositors and free-flying males, and is considered a galler

instead of a competitor because it lays its eggs in the fig wall instead of in an inflorescence. Because the morphologies and lifestyles of *Idarnes 'flavicollis'* and *'carne'* groups are similar to one another, yet differ so radically from the *Idarnes 'incerta'* group, they are often referred to as *Idarnes 'sensu stricto'* and *Idarnes 'incerta'*, respectively (West *et al.* 1996; Bernhard *et al.* submitted).

Heterandrium (Pteromalidae, subfamily Otitesellinae), *Aepocerus* (Pteromalidae, subfamily Otitesellinae), and *Idarnes 'incerta'* (subfamily Sycophaginae) are common galler wasps found on *Urostigma Americana* figs in Panama (Boucek 1988; Boucek 1993). *Aepocerus* is the most common, occurring in up to 60% of figs in some crops (Bronstein 1991). All three wasps produce large galls that extend into the syconium. In addition, both *Aepocerus* and *Heterandrium* appear to be able to prevent the abortion of unpollinated or under-pollinated figs (Bronstein 1991; West *et al.* 1996; W. A. Marussich, personal observation). The last wasp genus included in this study is *Physothorax* (Torymidae), a common parasitoid wasp that preys on *Aepocerus* larvae (West *et al.* 1996). *Physothorax* wasps have large ovipositors, similar to *I. 'sensu stricto'*, and oviposit into *Aepocerus* galls from the exterior of the fig. *Idarnes 'incerta'*, *Aepocerus*, and *Physothorax* all have free-flying males and females, thus mating likely takes place outside the fig. *Heterandrium* has both winged and wingless males, and winged females, so mating likely takes place both inside and outside the syconium.

DNA methods and phylogenetic analyses

Genomic DNA was extracted from individual wasps using the Puregene DNA extraction tissue kit (Gentra Systems). Phylogenies of pollinating (*Pegoscapus*) and nonpollinating (*Idarnes*, *Heterandrium*, *Aepocerus*, *Physothorax*) wasps were reconstructed using the mitochondrial cytochrome oxidase subunit I (COI) gene. We also included several *Tetrapus* (pollinator) and *Critogaster* (competitor) wasps from four New World freestanding figs (subgenus *Pharmacosyceae*, section *Pharmacosyceae*) as outgroups. A total of 822 base pairs of COI were amplified using the primers *New Jerry* (TTGATTTTTGGTCATCCAGAAGT) and *New Pat* (TCCAATGCACTAATCTGCCAT), and PCR products were directly sequenced in both directions using standard protocols. Sequences were cleaned and aligned using SEQUENCHER version 4.5 (GeneCodes) and assembled in SE-AL version 2.0 (Rambaut 1996). Although we recognize the drawbacks of using mtDNA sequences for barcoding (i.e. their higher probability of monophyly compared to nuclear genes and higher probability of introgression in hybridizing organisms; Hudson & Turelli 2003), previous studies of fig wasps have shown a perfect correlation of mtDNA and either microsatellite data or nuclear genealogies, and evidence of introgression has yet to be observed

Table 1 Total numbers of wasps (N) sequenced, and numbers of unique (U) and shared (S) wasp species found per fig species by wasp genera (or species-group). Shared host species are the fig species from which the same species of wasps were collected. In cases with multiple shared wasp species per fig species, shared host species for each wasp species are separated with a semicolon. All wasps were collected in Panama, except for wasps from *F. velutina* (Costa Rica), *F. laevigata* (Florida), and *F. petiolaris* (Arizona)

Fig Species	<i>Pegoscopus</i>				<i>Idarnes carme</i>				<i>I. flavicollis</i>				<i>I. incerta</i>				<i>Heterandrium</i>				<i>Aepocerus</i>				<i>Physothorax</i>			
	N	U	S	Shared hosts	N	U	S	Shared hosts	N	U	S	Shared hosts	N	U	S	Shared hosts	N	U	S	Shared hosts	N	U	S	Shared hosts	N	U	S	Shared hosts
1 <i>F. paraensis</i>	1	1	0	—	1	1	0	—	3	1	0	—	0	0	0	—	0	0	0	—	0	0	0	—	0	0	0	—
2 <i>F. obtusifolia</i>	28	2	0	—	4	3	0	—	1	0	1	4,5,11	0	0	0	—	2	2	0	—	11	1	3	6; 8a; 8b	3	3	0	—
3 <i>F. citrifolia</i>	9	1	0	—	9	1	0	—	0	0	0	—	3	1	0	—	0	0	0	—	0	0	0	—	1	1	0	—
4 <i>F. popenoei</i>	30	1	1	7,11	17	1	1	5,7	9	0	1	2,5,11	0	0	0	—	2	0	1	8,9	0	0	0	—	0	0	0	—
5 <i>F. nymphaeifolia</i>	14	1	0	—	2	0	1	4,7	3	0	1	2,4,11	0	0	0	—	0	0	0	—	0	0	0	—	0	0	0	—
6 <i>F. trigonata</i>	13	1	0	—	22	2	1	7,11	1	0	1	7	2	1	0	—	1	1	0	—	6	0	1	2	5	0	1	8
7 <i>F. near trigonata</i>	6	1	1	4,11	2	0	2	6,11; 4,5	1	0	1	6	1	0	1	8	0	0	0	—	4	1	0	—	0	0	0	—
8 <i>F. dugandii</i>	13	1	0	—	21	1	0	—	0	0	0	—	1	0	1	7	8	0	2	4,9; 9,14	13	1	2	2a; 2b	11	3	1	6
9 <i>F. turbinata</i>	1	1	0	—	0	0	0	—	3	1	0	—	1	1	0	—	7	0	2	4,8; 8,14	0	0	0	—	0	0	0	—
10 <i>F. pertusa</i>	1	1	0	—	0	0	0	—	0	0	0	—	0	0	0	—	0	0	0	—	0	0	0	—	0	0	0	—
11 <i>F. bullenei</i>	10	1	1	4,7	5	0	1	6,7	6	0	1	2,4,5	0	0	0	—	0	0	0	—	0	0	0	—	0	0	0	—
12 <i>F. colubrinae</i>	4	0	1	13	4	1	0	—	0	0	0	—	0	0	0	—	0	0	0	—	0	0	0	—	0	0	0	—
13 <i>F. perforata</i>	6	1	1	12	0	0	0	—	6	1	0	—	0	0	0	—	0	0	0	—	0	0	0	—	0	0	0	—
14 <i>F. costaricana</i>	1	1	0	—	21	2	0	—	0	0	0	—	0	0	0	—	5	0	1	8,9	1	1	0	—	0	0	0	—
15 <i>F. velutina</i>	1	1	0	—	0	0	0	—	1	1	0	—	0	0	0	—	0	0	0	—	1	1	0	—	1	1	0	—
16 <i>F. laevigata</i>	1	1	0	—	5	1	0	—	0	0	0	—	0	0	0	—	0	0	0	—	0	0	0	—	0	0	0	—
17 <i>F. petiolaris</i>	4	1	0	—	7	1	0	—	0	0	0	—	0	0	0	—	10	2	0	—	0	0	0	—	0	0	0	—
18 Totals	156	17	2		120	14	2		34	4	2		8	3	1		35	5	2		36	5	3		21	8	1	

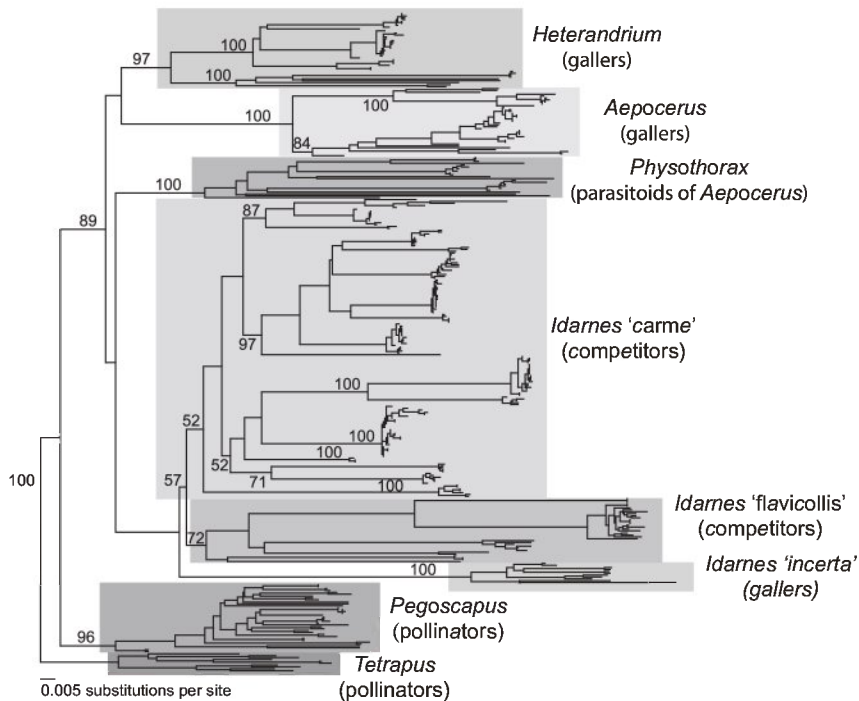

Fig. 1 Neighbour-joining (NJ) tree containing all 411 sequences used in the initial analyses. Different wasp genera (and subgenera) are indicated with coloured boxes. Bootstrap values (> 50%) based on 1000 NJ replicates are indicated.

among closely related fig wasps (Molbo *et al.* 2003; Molbo *et al.* 2004; C. A. Machado, unpublished data).

We obtained a total of 411 COI sequences (Table 1, Fig. 1), and used PAUP* version 4.0b to conduct phylogenetic analyses (Swofford 2002). We first constructed a neighbour-joining tree using all 411 sequences (Fig. 1), and then reconstructed phylogenies for each wasp genus (and species-groups in the case of *Idarnes*) using maximum likelihood (ML) methods and the general reversible model of base substitution with rate heterogeneity (REV + Γ). To test for incidences of host-switching, we constrained all wasps collected from the same fig host species to be monophyletic. Then, for each wasp genus, we conducted topological comparisons of the best unconstrained ML tree and the best ML tree constrained to monophyly by fig host species using the Shimodaira-Hasegawa (SH) one-tailed test with resampling of estimated log likelihoods (RELL) bootstrap (1000 replications). For a given genus, all wasp species collected from the same fig species were constrained both simultaneously (i.e. all wasps constrained to monophyly by fig host species) and individually (i.e. only wasps collected from one fig host species constrained at a time) to see if one or a few species were mainly responsible for the patterns of host-specificity observed. In the case of *Idarnes*, we constrained all wasps together by fig host, regardless of species-group, and also with wasps from each species-group (*carne*, *flavicollis*, *incerta*) constrained separately. As both *Heterandrium* and *Aepocerus* also appear to contain two species-groups each (see Figs 1, 4, and 5), we constrained

them to monophyly by fig species, both as single monophyletic clades and divided into their respective species-groups. Rejection of monophyly indicates that genera are likely diversifying through host-switching or parallel radiations.

Due to computational constraints, we pruned the tips of the branches of our ML trees until we were left with 69 distinct 'molecular species' of wasps (Table 1). To determine these distinct wasp 'species' we compared the Tamura-Nei pairwise distances (Tamura & Nei 1993) for all sequences on the tip of each branch, and if the differences within a particular branch tip were less than 2%, and the differences compared to the next nearest branch were 6% or greater, we designated all individuals on that branch to be of the same species. This approach worked well and there were no ambiguous cases. We then randomly selected one sequence from each 'molecular species' to represent that species in the cophylogenetic analyses. See Table S1 (Supplementary material) for pairwise distances from a representative subset of wasp species. For the remainder of the paper we will refer to these 69 differentiated genetic groups as 'species.' Because all of the nonpollinators and several of the pollinators are currently undescribed below the genus level, we assigned temporary species names based on the fig host species they were collected from, e.g. *I. 'popenoei'* refers to a genetically distinct group of *Idarnes* wasps collected from the fig species *F. popenoei*. In cases in which one wasp species was collected from multiple fig hosts, all fig species names were incorporated into the wasp

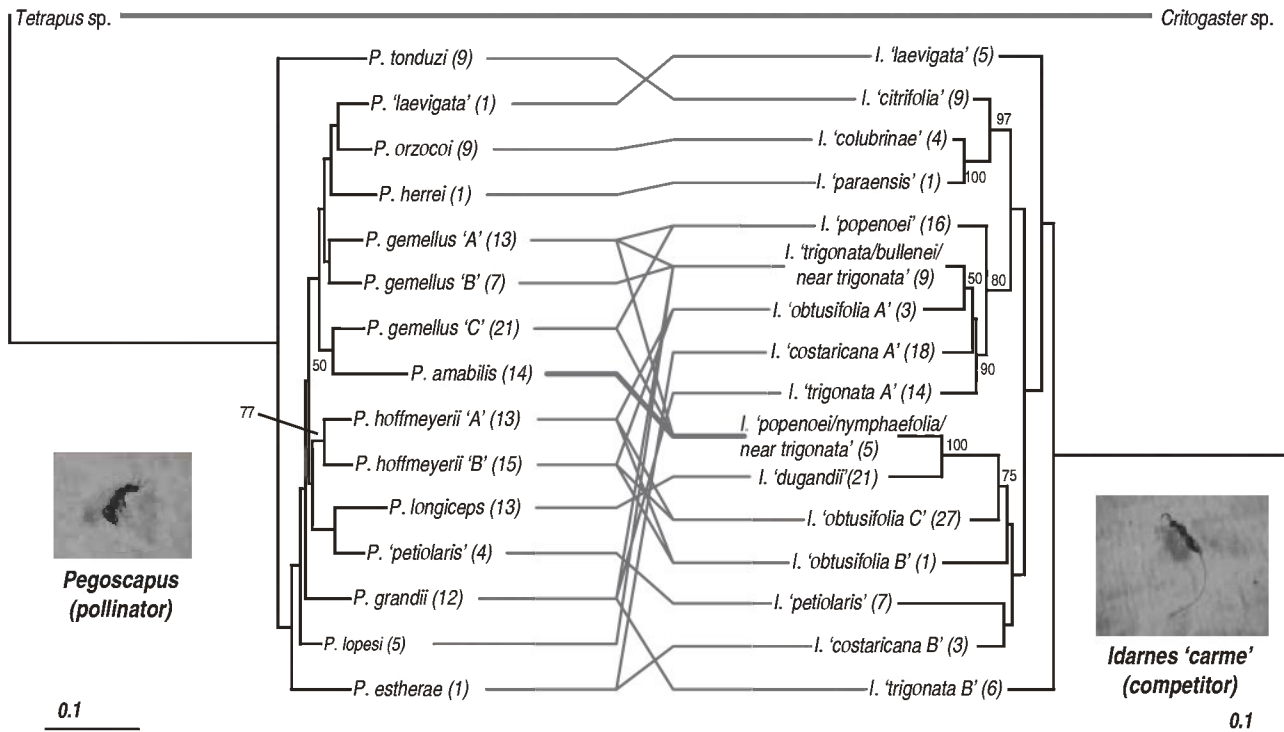

Fig. 2 Tanglegram comparing maximum likelihood (ML) trees of fig pollinators (*Pegoscapus*) and *Idarnes (carme)* competitors. Lines linking taxa are based on fig host species. Bootstrap values (> 50%) based on 1000 NJ replicates are indicated. Bold lines indicate significant links between taxa (PARAFIT, $P < 0.05$).

species name, e.g. *I. 'popenoei/nymphaefolia/near trigonata.'* Conversely, if there were multiple wasp species collected from the same fig species, they were distinguished by using A, B, etc. after the name, e.g. *I. 'obtusifolia A'* and *I. 'obtusifolia B'*. Numbers of sequenced individuals of each wasp species are indicated in parentheses on all trees (see Figs 2–8 plus Figs S1–S4, Supplementary material), and representative COI sequences for each of these 69 distinct wasp species are available from GenBank (Accession numbers: EF158858–EF159145). We then determined the numbers of shared and unique wasp species for each wasp genus (or species-group) and conducted an $R \times C$ -test of independence using a G-test (Sokal & Rohlf 1995) to determine whether the frequency of shared vs. unique wasp species varies by wasp genus.

Cophylogenetic analyses

Several statistical methods have been developed over the past decade to test for evidence of cospeciation using phylogenies and DNA sequence data (Page 1994; Paterson & Banks 2001; Legendre *et al.* 2002; Brooks *et al.* 2004; Siddall 2004; Stevens 2004; Siddall 2005). We selected three of the most commonly used software packages, TREEMAP 1.0 (Page 1995), TREEMAP 2.02 β (Charleston & Page 2002),

and PARAFIT (Legendre *et al.* 2002), to test for congruence between phylogenies of the different fig wasp genera (and species-groups for *Idarnes*, *Heterandrium*, and *Aepocerus*). We tested the degree of congruence between the phylogenies of each of the nonpollinator groups (*I. 'carme'*, *I. 'flavicollis'*, *I. 'incerta'*, *Heterandrium*, *Aepocerus*, and *Physothorax*) with the pollinators (*Pegoscapus*), the gallers and parasitoid (*I. 'incerta'*, *Heterandrium*, *Aepocerus*, and *Physothorax*) with the competitors (*I. 'sensu stricto'*), and the parasitoid (*Physothorax*) with its galling wasp host (*Aepocerus*), for a total of 22 different pairwise comparisons. For the analyses, we divided *Idarnes* into their three separate species-groups (i.e. *flavicollis*, *carme*, and *incerta*), and also lumped *Idarnes 'carme'* and *I. 'flavicollis'* together into *I. 'sensu stricto'* because *I. 'carme'* and *I. 'flavicollis'* are both competitors, and even though their morphological differences are well-defined (Boucek 1988; Boucek 1993; Bernhard *et al.* submitted), our COI phylogeny only provides weak support for their classification as separate monophyletic groups (Fig. 1). We also further divided the *Aepocerus* and *Heterandrium* phylogenies into two distinct, well-supported species-groups (A and B) for some analyses (Fig. 1). We linked phylogenies together by fig host species; wasp species that did not have a corresponding species from the same fig host to link with were eliminated from the analysis, as they

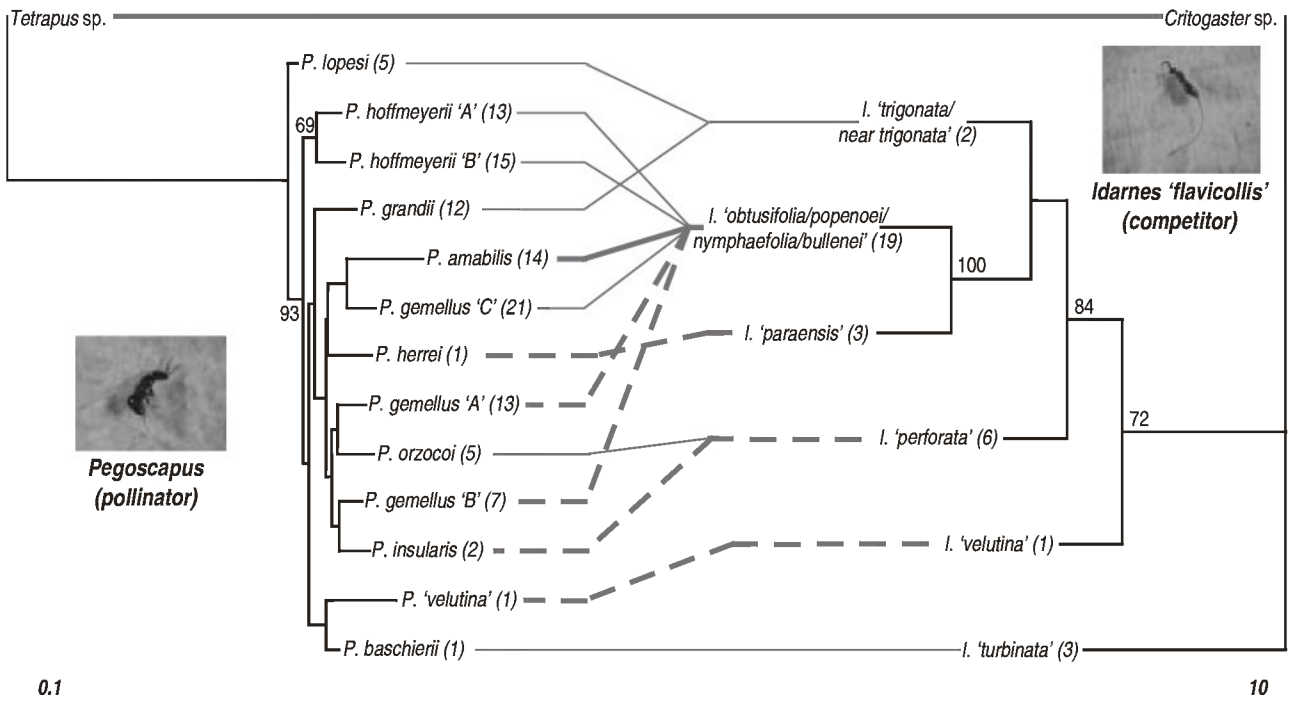

Fig. 3 Tanglegram comparing maximum likelihood (ML) trees of fig pollinators (*Pegoscapus*) and *Idarnes* (*flavicollis*) competitors. Lines linking taxa are based on fig host species. Bootstrap values (> 50%) based on 1000 NJ replicates are indicated. Bold lines indicate significant links between taxa (PARAFIT, $P < 0.05$), and dashed lines indicate marginally significant links between taxa (PARAFIT, $P < 0.1$).

are more likely to be missing due to incomplete sampling rather than an extinction event. Pictorial representation of these pairwise linked phylogenies are called tanglegrams (see Figs 2–8 and Figs S1–S4, Supplementary material). The three different cophylogenetic methods are described below:

TREEMAP 1.0 is the standard software program used for cophylogenetic analyses. It is a topology-based program that reconciles two trees using four types of events, i.e. cospeciation (C), host-switching (H), duplication (D), and sorting (S), to explain the differences between the phylogenies (Page 1994; Page 1995). We input the best pruned ML tree for two genera (or species-groups), and linked the taxa on the two trees by fig host species. Using parsimony, TREEMAP 1.0 suggests multiple reconstructions that attempt to maximize the number of cospeciations and minimize the number of noncospeciation events using either an exact search or a heuristic search algorithm. Then randomization tests are performed on each reconstruction to test whether the two phylogenies contain more cospeciation events than expected by chance.

TREEMAP 2.02 β is an updated version of TREEMAP that uses jungles instead of parsimony to reconcile two trees (Charleston 1998; Charleston & Page 2002). A jungle is a directed graph of all possible mappings of one tree onto another and, when solved, guarantees to deliver all potentially optimal solutions. The main drawback to using

jungles is that finding all potentially optimal solutions requires a significant amount of calculations, and thus the TREEMAP 2.02 β software program does not generally work when the number of links between taxa exceeds twenty. TREEMAP 2.02 β also allows the option to apply different 'costs' to each of the four cophylogenetic events and, using the timed analysis feature, branch length information can be incorporated as well. We used both timed and nontimed analyses and used the default cost settings of 0 for cospeciations and 1 for host-switching, duplications, and losses. Despite the advances in TREEMAP 2.02 β , both versions of TREEMAP are commonly used for cophylogenetic analyses.

PARAFIT is a distance-based approach that is not dependent upon fully resolved phylogenies. PARAFIT uses distance matrices to statistically test the global hypothesis of coevolution between two clades, and also tests the significance of each of the individual links between taxa (Legendre *et al.* 2002). PARAFIT calculates two statistics, PARAFITLink1 and PARAFITLink2; we chose to use PARAFITLink1 because it is more conservative and reduces type I error, especially in situations in which portions of the two trees are coevolutionary while other portions are not (Legendre *et al.* 2002). For each of the 22 pairwise wasp combinations we used both pairwise total character differences and pairwise Tamura–Nei distances to construct the input matrices for use in the PARAFIT analyses; however, we present only the Tamura–Nei results. Significant links between the taxa

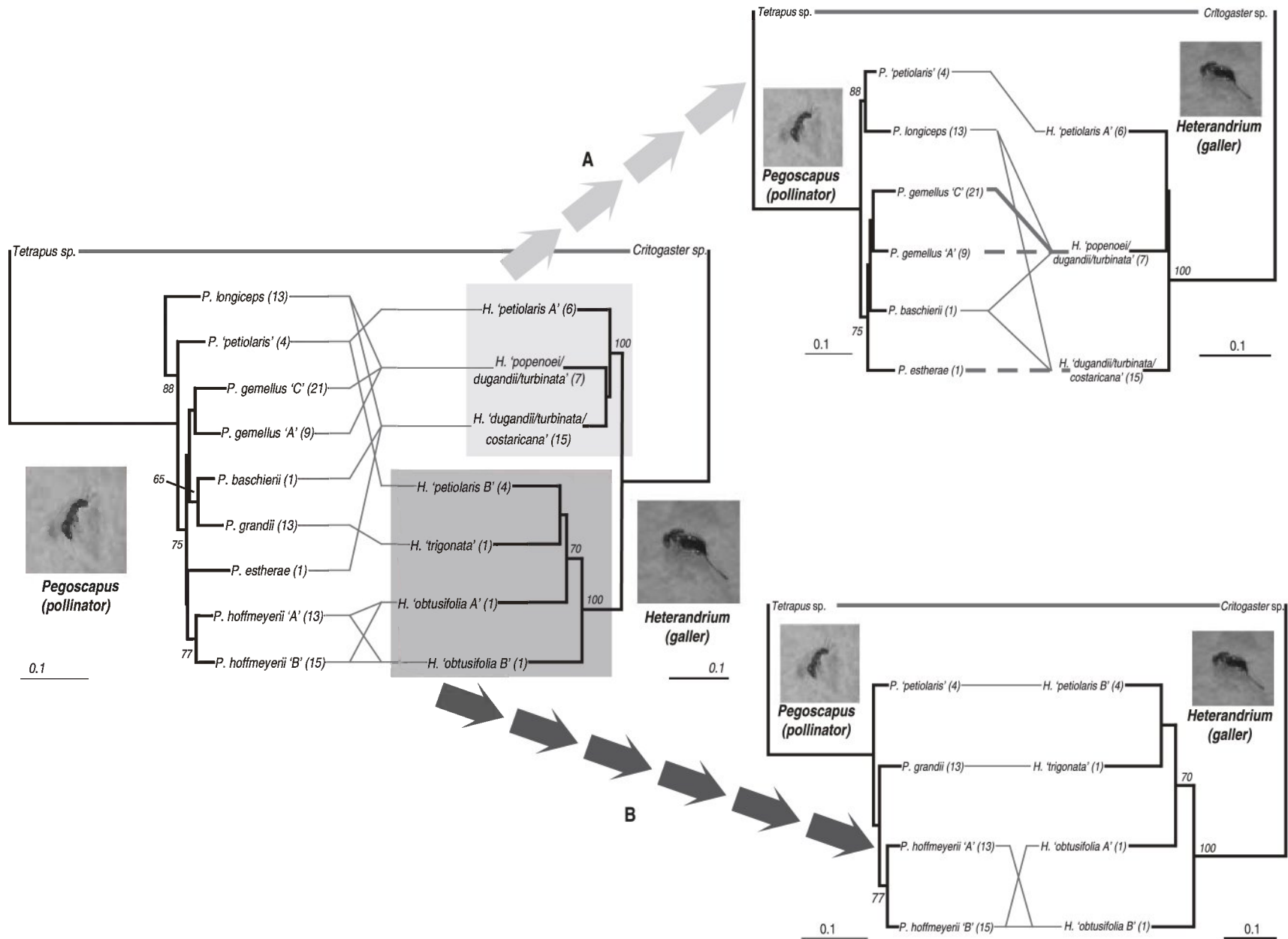

Fig. 4 Tanglegram comparing maximum likelihood (ML) trees of fig pollinators (*Pegoscapus*) and *Heterandrium* galler. Lines linking taxa are based on fig host species. Bootstrap values (> 50%) based on 1000 NJ replicates are indicated. *Heterandrium* phylogeny is split into two well-supported clades, A and B, for further analysis. Bold lines indicate significant links between taxa (PARAFIT, $P < 0.05$), and dashed lines indicate marginally significant links between taxa (PARAFIT, $P < 0.1$).

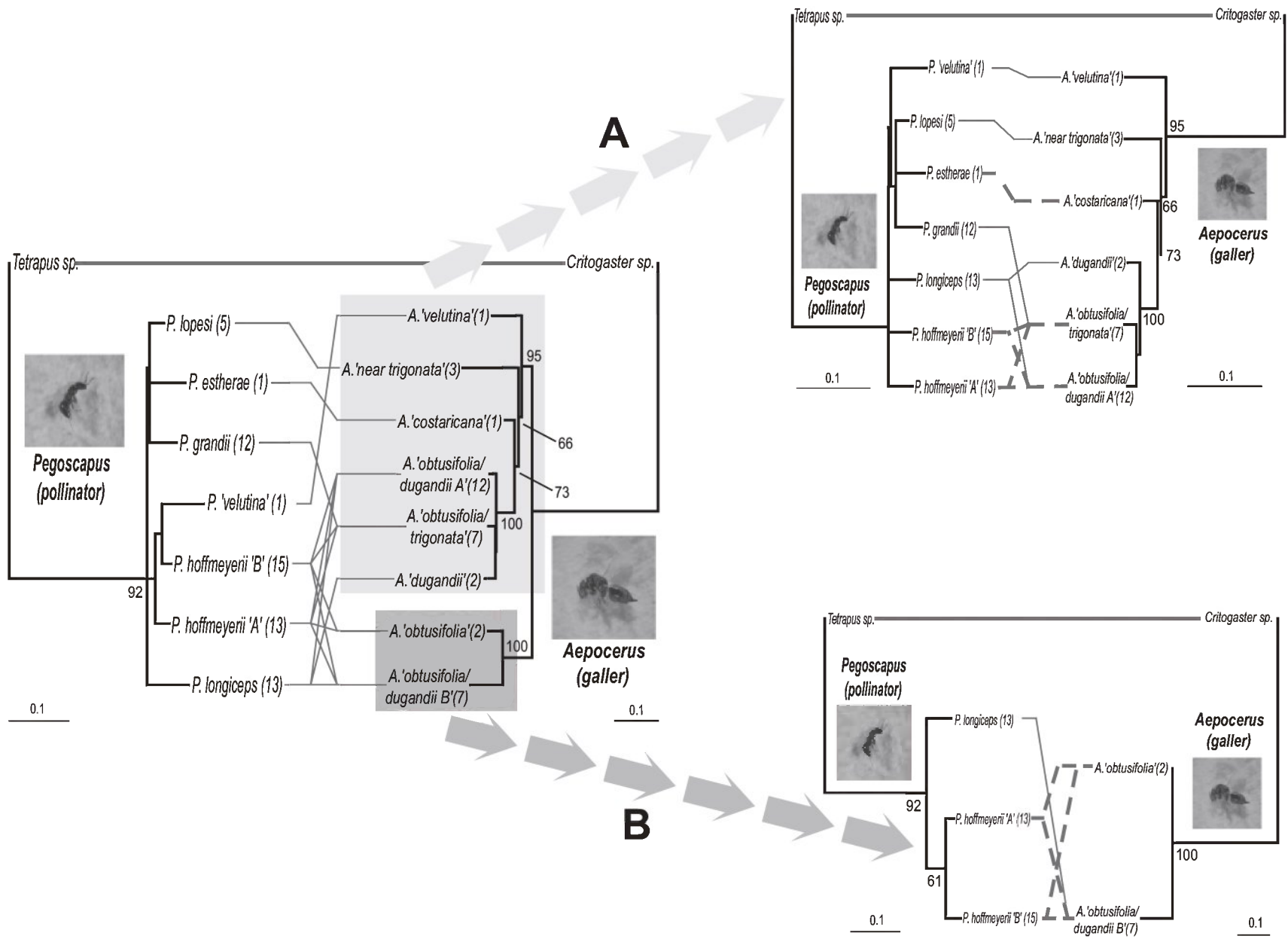

Fig. 5 Tanglegram comparing maximum likelihood (ML) trees of fig pollinators (*Pegoscapus*) and *Aepocerus* galler. Lines linking taxa are based on fig host species. Bootstrap values (> 50%) based on 1000 NJ replicates are indicated. *Aepocerus* phylogeny is split into two well-supported clades, A and B, for further analysis. Bold lines indicate significant links between taxa (PARAFIT, $P < 0.05$), and dashed lines indicate marginally significant links between taxa (PARAFIT, $P < 0.1$).

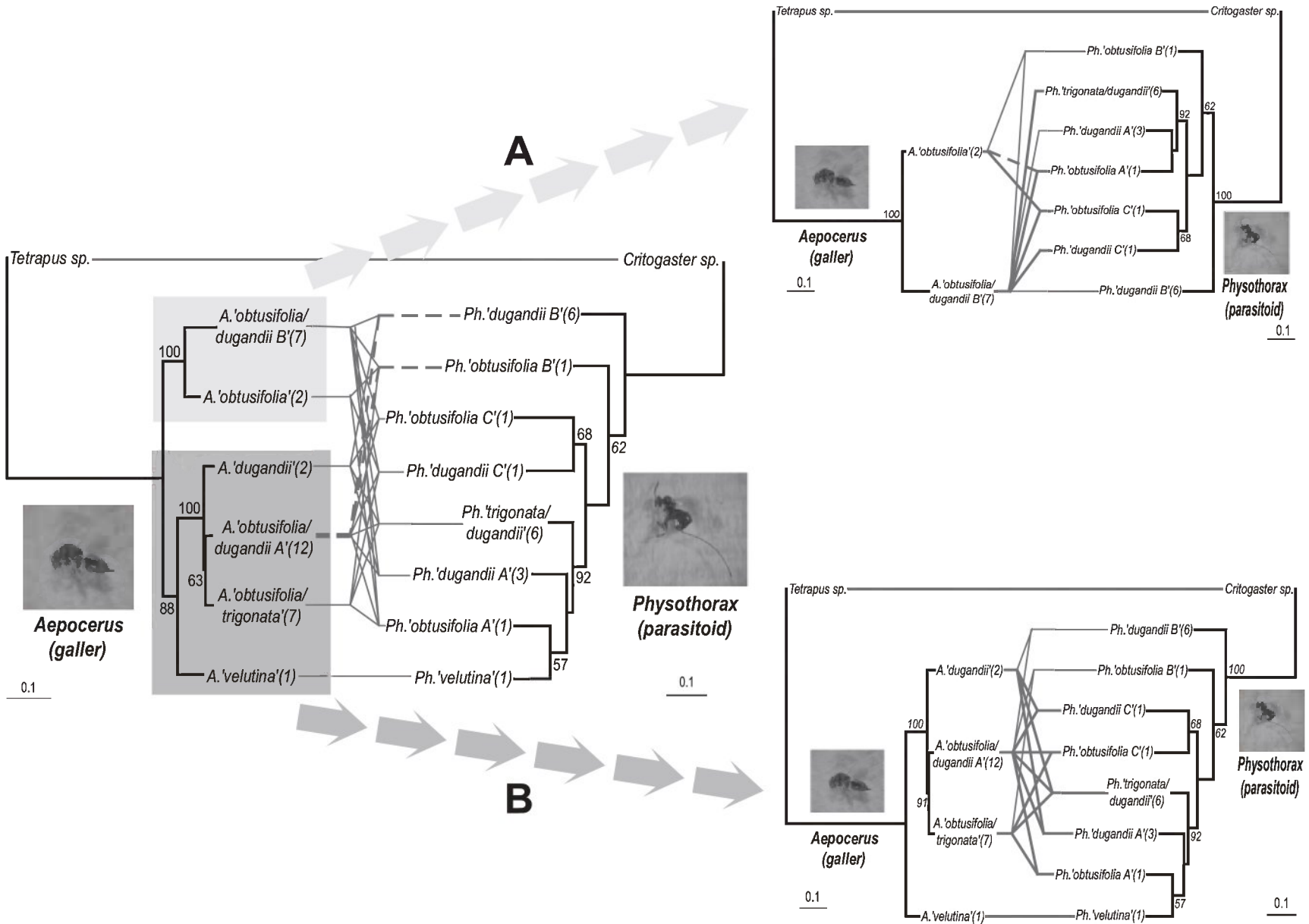

Fig. 6 Tanglegram comparing maximum likelihood (ML) trees of a galling fig wasp (*Aepocerus*) and its parasitoid (*Physothorax*). Lines linking taxa are based on fig host species. Bootstrap values (> 50%) based on 1000 NJ replicates are indicated. *Aepocerus* phylogeny is split into two well-supported clades, A and B, for further analysis. Bold lines indicate significant links between taxa (PARAFIT, $P < 0.05$), and dashed lines indicate marginally significant links between taxa (PARAFIT, $P < 0.1$).

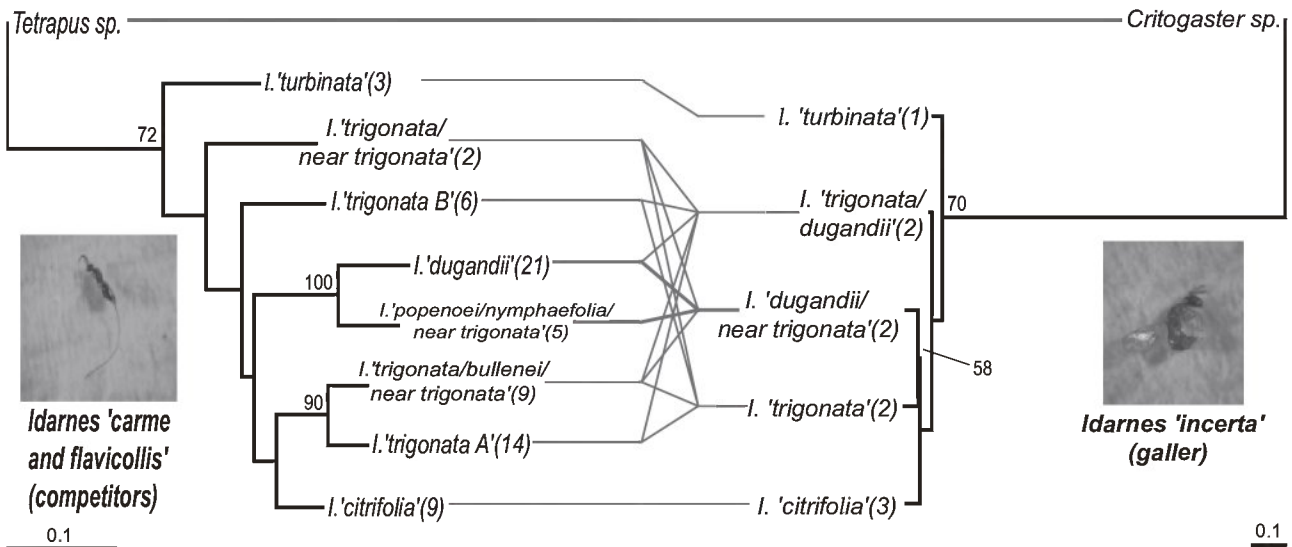

Fig. 7 Tanglegram comparing maximum likelihood (ML) trees of *Idarnes* 'sensu stricto' competitors and *Idarnes* 'incerta' galler. Lines linking taxa are based on fig host species. Bootstrap values (> 50%) based on 1000 NJ replicates are indicated. Bold lines indicate significant links between taxa (PARAFIT, $P < 0.05$).

were indicated on the TREEMAP tanglegrams (Figs 2–8, plus Figs S1–S4, Supplementary material); a solid line indicates a probability of $P < 0.05$ and a dashed line indicates a probability of $P < 0.1$. We chose to indicate links with probabilities of $0.05 < P < 0.1$ on our figures because many pairwise species links had probabilities in this range, and we felt that it is informative to be able to see these trends. Tables presenting actual values for each of the individual species links are available online (Tables S2–S13, Supplementary material).

Results

Phylogenetic analyses and tests of host-switching

The global phylogeny (Fig. 1) shows that the Neotropical nonpollinating wasps form a monophyletic group that is distinct from the pollinators, and is in agreement with three less detailed phylogenetic studies (Machado *et al.* 1996; Machado 1998; Rasplus *et al.* 1998). In addition, the four nonpollinating wasp genera (*Idarnes*, *Heterandrium*, *Aepocerus*, and *Physothorax*) all form distinct, monophyletic clades (Fig. 1). All genera are well-supported (bootstrap values 97–100%), with the exception of the *Idarnes* species complex (Fig. 1; bootstrap value 61%). *Heterandrium* and *Aepocerus*, both galler from subfamily Otitesellinae, grouped together in agreement with their taxonomic classification, although in a poorly supported clade. Further, each of those two genera can be divided into two well-supported species-groups (see Figs 1, 4, and 5). Although *Idarnes* species-groups do form three distinct clades corresponding

to *I. 'carme'*, *I. 'flavicollis'*, and *I. 'incerta'*, only the *I. 'incerta'* clade had high bootstrap support (Fig. 1; bootstrap values 52%, 72%, and 100%, respectively), hence we also combined *I. 'carme'* and *I. 'flavicollis'* into *I. 'sensu stricto'* for several cophylogenetic analyses. Interestingly, *Physothorax*, a member of Chalcid family (Torymidae), is part of the strongly supported clade containing all Neotropical nonpollinators from family Pteromalidae (*Heterandrium*, *Aepocerus*) and the undefined family containing *Idarnes* (Fig. 1), indicating once again that family Agaonidae, as defined by Bouček (1988, 1993), is not monophyletic (Machado *et al.* 1996; Machado 1998; Rasplus *et al.* 1998).

Topological comparisons of the best unconstrained ML tree and the best ML tree constrained to monophyly by fig species (SH test with 1000 RELL bootstrap) show that none of the wasp genera are monophyletic with respect to fig host species: *Idarnes* (all three species-groups combined: $\Delta -\ln L = 3029.63$, $P < 0.001$; all three species-groups constrained individually: $\Delta -\ln L = 678.46$, $P < 0.001$), *Heterandrium* ($\Delta -\ln L = 3250.02$, $P < 0.001$; each species-group constrained individually: $\Delta -\ln L = 678.46$, $P < 0.001$), *Aepocerus* ($\Delta -\ln L = 349.84$, $P < 0.001$; each species-group constrained individually: $\Delta -\ln L = 100.11$, $P < 0.001$), *Physothorax* ($\Delta -\ln L = 78.87$, $P < 0.001$), and *Pegoscopus* ($\Delta -\ln L = 89.91$, $P < 0.001$). Individual SH tests by fig species revealed that several wasp species co-occurring on particular fig species were responsible for the rejection of monophyly. For *I. 'carme'*, multiple wasp species occurring on *F. popenoei*, *F. trigonata*, *F. near trigonata*, and *F. costaricana* all rejected monophyly ($P < 0.05$). For *Heterandrium*, multiple wasp species occurring on *F. dugandii* and *F. turbinata* were

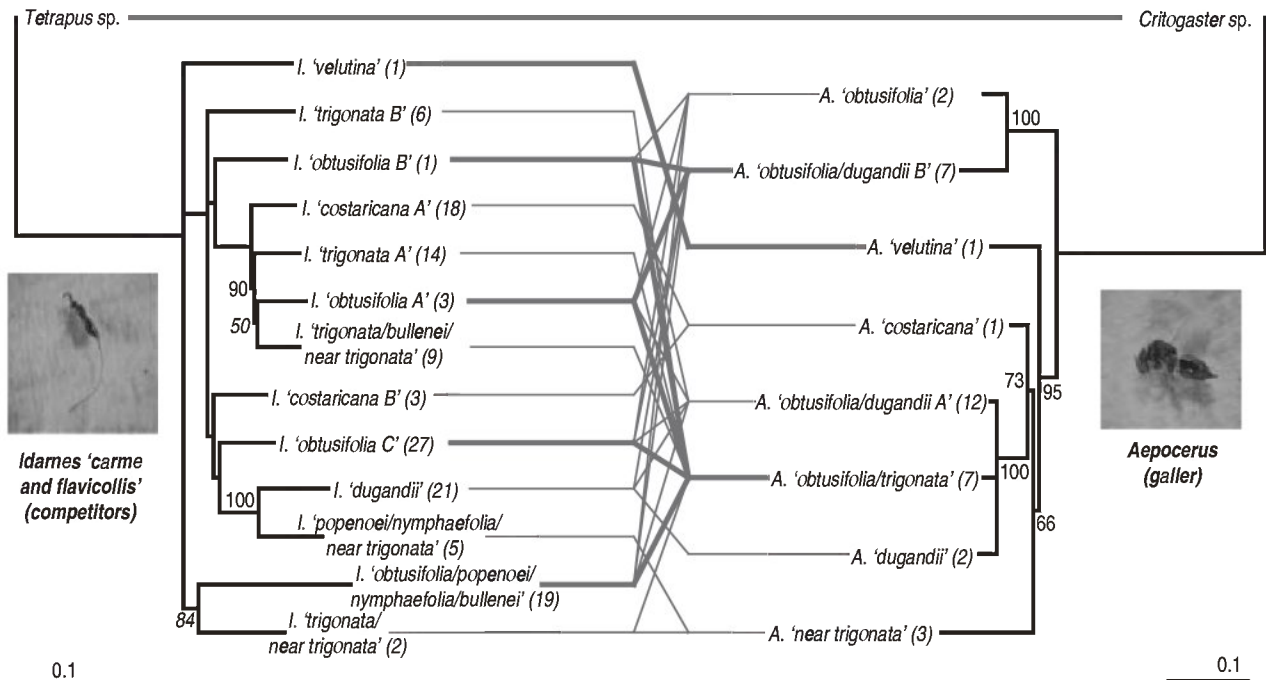

Fig. 8 Tanglegram comparing maximum likelihood (ML) trees of *Idarnes* 'sensu stricto' competitors and one group of gallers (*Aepocerus*). Lines linking taxa are based on fig host species. Bootstrap values ($> 50\%$) based on 1000 NJ replicates are indicated. *Aepocerus* phylogeny is split into two well-supported clades, A and B, for further analysis. Bold lines indicate significant links between taxa (PARAFIT, $P < 0.05$), and dashed lines indicate marginally significant links between taxa (PARAFIT, $P < 0.01$).

responsible for the rejection of monophyly ($P < 0.001$). For both *Aepocerus* and *Physothorax*, wasp species occurring across *F. obtusifolia* and *F. dugandii* were responsible for the rejection of monophyly ($P < 0.01$). Thus, for all wasp types except *I. 'flavicollis'* and *I. 'incerta'*, for which we did not find multiple wasp species co-occurring on the same fig host, there is strong evidence for diversification through host-switching or parallel radiation.

All wasp genera (or species-groups) contained wasp species that were shared across multiple fig species, and several fig species were host to multiple species of wasps from the same genus (Table 1). The proportion of unique wasp species ranged from 0.625 for the gallers *Aepocerus* and *Heterandrium*, to 0.895 for the pollinator *Pegoscapus*, but the ratio of unique to shared wasp species did not vary across species-groups ($R \times C$ test of independence, $G = -1.035$, d.f. = 6, $P = 0.959$). The highest wasp diversity was found on *F. obtusifolia*: three unique species of *Pegoscapus*, three unique species of *I. 'carne'*, two unique species of *Heterandrium*, one unique species of *Aepocerus*, and three unique species of *Physothorax*. In addition, *F. obtusifolia* contained single species of both *I. 'flavicollis'* and *Aepocerus* that each co-occurred across three different species of figs. *Idarnes 'carne'* wasps were found co-occurring across five fig species, *I. 'flavicollis'* wasps were found co-occurring across six fig species, and *Heterandrium* wasps were found

co-occurring across four fig species (Table 1). *Idarnes 'carne'*, *Heterandrium*, and *Physothorax* all have multiple wasp species co-occurring on a given fig species. Interestingly, host-switching (inferred from cases of host sharing) was most common among the competitors (*I. 'carne'* and *I. 'flavicollis'*), and least common among the parasitoid (*Physothorax*) and one of the gallers (*I. 'incerta'*), although sample size may explain the latter observation as the number of observed species in *I. 'incerta'* was very small.

Cophylogenetic analyses

TREEMAP 1.0. We used TREEMAP 1.0 to construct tanglegrams (see Figs 2–8 and Figs S1–S4, Supplementary material), and then conducted both heuristic and exact searches for each of the 17 different wasp associations we tested (Table 2). The maximum numbers of cospeciation events for each of the associations remained constant, even when host switches and duplications were included, using both exact and heuristic searches. We tested whether the numbers of cospeciation events were greater than could be obtained by chance alone by repeatedly randomly permuting the parasite tree and recalculating the number of cospeciation events between the two trees. One thousand random parasite trees were generated for each association using the

Table 2 Summary of TREEMAP 1.0 comparisons between wasp phylogenies. Values in bold indicate the number of cospeciations observed is not likely due to chance ($P < 0.05$)

'Host'	<i>n</i> *	'Parasite'	<i>n</i> *	No. of cospeciations	No. of duplications	No. of host switches	No. of sorting events	<i>P</i> †	Figure
<i>Pegoscapus</i>	15	<i>Idarnes 'carne'</i>	16	6	10	1	68	0.22	2
<i>Pegoscapus</i>	13	<i>Idarnes 'flavicollis'</i>	6	1	5	0	29	0.97	3
<i>Pegoscapus</i>	5	<i>Idarnes 'incerta'</i>	4	1	4	0	13	0.95	S1
<i>Pegoscapus</i>	9	<i>Heterandrium</i>	7	2	4	1	15	0.16	4
<i>Pegoscapus</i>	6	<i>Heterandrium (group A)</i>	3	1	2	0	6	0.81	4
<i>Pegoscapus</i>	4	<i>Heterandrium (group B)</i>	4	2	2	0	5	0.41	4
<i>Pegoscapus</i>	7	<i>Aepocerus</i>	8	2	6	0	21	0.16	5
<i>Pegoscapus</i>	7	<i>Aepocerus (group A)</i>	6	1	1	0	1	0.63	5
<i>Pegoscapus</i>	3	<i>Aepocerus (group B)</i>	2	2	5	0	5	0.36	5
<i>Pegoscapus</i>	5	<i>Physothorax</i>	8	4	4	0	7	0.01	S2§
<i>Aepocerus</i>	6	<i>Physothorax</i>	8	1	7	0	19	0.92	6
<i>Aepocerus (group A)</i>	2	<i>Physothorax</i>	7	1	6	0	4	0.95	6
<i>Aepocerus (group B)</i>	4	<i>Physothorax</i>	8	2	6	0	11	0.21	6
<i>Idarnes 'sensu stricto'</i> ‡	8	<i>Idarnes 'incerta'</i>	4	2	2	0	9	0.00	7
<i>Idarnes 'sensu stricto'</i> ‡	15	<i>Heterandrium</i>	7	1	6	0	47	0.93	S3§
<i>Idarnes 'sensu stricto'</i> ‡	13	<i>Aepocerus</i>	8	2	6	0	42	0.02	8
<i>Idarnes 'sensu stricto'</i> ‡	10	<i>Physothorax</i>	8	2	6	0	36	0.03	S4§

*Number of wasp species in each phylogeny; †Probability of generating the same number of cospeciations or higher based on 1000 random parasite trees; ‡*Idarnes 'sensu stricto'* encompasses both competitor wasp groups: *I. 'carne'* and *I. 'flavicollis'*; §Figures available online.

proportional-to-distinguishable option, and a distribution of the number of cospeciation events was generated for each association. The resulting histograms suggest that the observed numbers of cospeciation events were not significantly greater than what would be expected by chance ($P > 0.05$, Table 2) for all associations except *Pegoscapus*–*Physothorax* ($P = 0.01$; Fig. S2, Supplementary material), *Idarnes 'sensu stricto'*–*Idarnes 'incerta'* ($P < 0.001$, Fig. 7), *Idarnes 'sensu stricto'*–*Aepocerus* ($P = 0.02$, Fig. 8), and *Idarnes 'sensu stricto'*–*Physothorax* ($P = 0.03$; Fig. S4, Supplementary material).

TREEMAP 2.02β. We used TREEMAP 2.02β to conduct both timed and nontimed analyses. Timed analyses incorporate both topology and branch length information, whereas nontimed analyses only use topology information. Unfortunately, due to computing constraints we were only able to create timed jungles for 6 of the 17 associations, none of which were statistically significant (data not shown). Also due to computing constraints, we were unable to create jungles and/or optimal reconstructions for *Pegoscapus*–*I. 'carne'* (Fig. 2); however, we were able to create nontimed jungles and optimal reconstructions for all 16 other wasp associations (Table 3).

As with the TREEMAP 1.0 analyses (Table 2), the TREEMAP 2.02β analyses (Table 3) resulted in a significant global fit between both *Pegoscapus*–*Physothorax* ($P = 0.04 \pm 0.01$; Fig. S4, Supplementary material) and *Idarnes 'sensu*

stricto'–*Idarnes 'incerta'* ($P = 0.01 \pm 0.01$, Fig. 7); however, the maximum numbers of cospeciations were 8 and 6, respectively, for the TREEMAP 2.02β analyses, compared to 4 and 2, respectively, for the TREEMAP 1.0 analyses. In addition, we also found evidence of significant congruence between *Pegoscapus*–*Idarnes 'incerta'* (eight cospeciations, $P = 0.01 \pm 0.01$; Fig. S1, Supplementary material) and *Aepocerus (group B)*–*Physothorax* (four cospeciations, $P = 0.01 \pm 0.01$, Fig. 6). In general, the TREEMAP 2.02β analyses resulted in reconstructions with more cospeciations, host switches, and duplications, but fewer sorting events (or losses) than the TREEMAP 1.0 analyses.

PARAFIT. PARAFIT results for each of the 22 pairwise wasp combinations are presented in Table 4. Tables listing the individual PARAFITLink1 values and probabilities for each of the pairwise taxa links for each of the comparisons are listed online (Tables S2–S13, Supplementary material). Significant pairwise links between the taxa are also indicated on the TREEMAP tanglegrams (Figs 2–8, plus Figs S1–S4, Supplementary material); a solid line indicates a probability of $P < 0.05$ and a dashed line indicates a probability of $P < 0.1$. Links between outgroup taxa were always significant, but were never responsible for a significant global fit probability, and thus are not included in counts of significant individual host–parasite links.

When comparing the pollinators (*Pegoscapus*) with the competitors (*I. 'sensu stricto'*), we found no global relationship

Table 3 Summary of untimed (no branch lengths) TREEMAP 2.02 β comparisons between wasp phylogenies. Values in bold indicate the number of cospeciations observed is not likely due to chance ($P < 0.05$)

'Host'	n*	'Parasite'	n*	POpt†	No. of cospeciations	No. of duplications	No. of losses	No. of host switches	cost	P‡	Figure
<i>Pegoscopus</i>	15	<i>Idarnes 'carne'</i>	16	—	—	—	—	—	—	—	2
<i>Pegoscopus</i>	13	<i>Idarnes 'flavicollis'</i>	6	42	0–6	6–12	0–20	0–6	15–26	0.48	3
<i>Pegoscopus</i>	5	<i>Idarnes 'incerta'</i>	4	4	0–8	2–10	0–5	0–5	4–9	0.01	S1¶
<i>Pegoscopus</i>	9	<i>Heterandrium</i>	7	59	0–8	6–14	0–16	0–7	16–20	0.12	4
<i>Pegoscopus</i>	6	<i>Heterandrium (group A)</i>	3	5	0–4	2–6	0–7	0–3	6–9	0.15	4
<i>Pegoscopus</i>	4	<i>Heterandrium (group B)</i>	4	14	0–4	4–8	0–7	0–4	8–11	0.66	4
<i>Pegoscopus</i>	7	<i>Aepocerus</i>	8	32	0–6	10–16	0–24	0–7	21–36	0.46	5
<i>Pegoscopus</i>	7	<i>Aepocerus (group A)</i>	6	3	0–2	2–4	0–2	0–1	4–5	0.27	5
<i>Pegoscopus</i>	3	<i>Aepocerus (group B)</i>	2	16	0–6	6–12	0–18	0–5	12–26	0.28	5
<i>Pegoscopus</i>	5	<i>Physothorax</i>	8	32	0–8	8–16	0–9	0–8	17–21	0.04	S2¶
<i>Aepocerus</i>	6	<i>Physothorax</i>	8	47	0–6	10–16	0–14	0–8	19–24	0.28	6
<i>Aepocerus (group A)</i>	2	<i>Physothorax</i>	7	6	0–6	8–14	0–3	0–5	11–13	0.13	6
<i>Aepocerus (group B)</i>	4	<i>Physothorax</i>	8	9	0–4	12–16	0–16	0–7	15–19	0.01	6
<i>Idarnes 'sensu stricto'</i> §	8	<i>Idarnes 'incerta'</i>	4	16	0–6	2–8	0–4	0–3	6–11	0.01	7
<i>Idarnes 'sensu stricto'</i> §	15	<i>Heterandrium</i>	7	56	0–6	8–14	0–21	0–7	16–29	0.24	S3¶
<i>Idarnes 'sensu stricto'</i> §	13	<i>Aepocerus</i>	8	16	0–8	8–16	0–22	0–7	18–32	0.14	8
<i>Idarnes 'sensu stricto'</i> §	10	<i>Physothorax</i>	8	54	0–8	8–16	0–27	0–8	21–37	0.08	S4¶

*Number of wasp species in each phylogeny; †Number of optimal reconstructions; ‡Lowest P -value obtained for any particular reconstruction; §*Idarnes 'sensu stricto'* encompasses both competitor wasp groups: *I. 'carne'* and *I. 'flavicollis'*; ¶Figures available online.

between phylogenies ($P = 0.336$); however, when *Idarnes 'sensu stricto'* was divided into *I. 'carne'* and *I. 'flavicollis'* for analysis, the global fit probabilities were 0.053 and 0.020, respectively. However, for *Pegoscopus*–*I. 'carne'* (Fig. 2) and *Pegoscopus*–*I. 'flavicollis'* (Fig. 3), respectively, tests of the individual host-parasite links show that only the link between one species pair was significant ($P < 0.05$). As we found high levels of host-switching and multiple wasps species per fig host for both *I. 'carne'* and *I. 'flavicollis'*, potential codivergences with the pollinator are likely obscured.

We found significant evidence of codivergence between the pollinators and the various galls. For *Pegoscopus*–*I. 'incerta'*, the global test of cospeciation indicated a significant global relationship between the *Pegoscopus* and *I. 'incerta'* phylogenies ($P = 0.047$; Fig. S1, Supplementary material), and the tests of the individual host-parasite links show significant links between two out of five species links ($P < 0.05$). For *Pegoscopus*–*Heterandrium*, the global test of cospeciation indicated no significant relationship between the *Pegoscopus* and *Heterandrium* phylogenies ($P = 0.186$), and no significant host-parasite links (Fig. 4). However, when the *Heterandrium* phylogeny was broken into two well-supported groups (see Fig. 4), the global tests of cospeciation for both groups are significant (Group A: $P = 0.031$; Group B: $P = 0.039$), suggesting a successful host-switch followed by cospeciation. For *Pegoscopus*–*Aepocerus*, when all possible links between taxa are considered, the global test of cospeciation indicates a marginally

significant global relationship between the phylogenies ($P = 0.071$), but no significant individual host-parasite links between taxa (Fig. 5). However, when *Aepocerus* is divided into two well-supported groups (see Fig. 5), the redistribution of links results in highly significant tests of global cospeciation (Group A: $P = 0.010$; Group B: $P = 0.024$), with multiple significant individual host-parasite links (Group A: 4 of 5 links with $P < 0.05$; Group B: 5 of 10 links with $P < 0.1$).

When comparing the pollinator (*Pegoscopus*) with the parasitoid of *Aepocerus* (*Physothorax*), the global test of cospeciation did not indicate a significant global relationship between phylogenies ($P = 0.206$), or individual host-parasite links (Fig. S2, Supplementary material). When comparing the galler (*Aepocerus*) and its parasitoid (*Physothorax*), there was a marginally significant global relationship between the phylogenies ($P = 0.079$, Fig. 6), but no significant individual host-parasite links. However, when *Aepocerus* was divided into two well-supported groups (see Fig. 6), the redistribution of links results in highly significant tests of global cospeciation (Group A: $P = 0.002$, Group B: $P = 0.008$) with multiple significant individual host-parasite links ($P < 0.05$; Group A: 5 of 10 links; Group B: 6 of 16 links), suggesting a successful host-switch followed by cospeciation.

Comparing the competitors (*I. 'sensu stricto'*) with the other nonpollinators yielded interesting results. The global test of cospeciation between *I. 'sensu stricto'* and the galler *I. 'incerta'* was highly significant ($P = 0.024$, Fig. 7). The test

Table 4 Summary of PARAFIT results. Values in bold indicate the level of congruence observed between the phylogenies is not likely due to chance ($P < 0.05$)

'Host'	'Parasite'	Total No. of links*	No. (%) links $P < 0.05^*$	No. (%) links $P < 0.1^*$	Global Fit Probability	Figur
<i>Pegoscapus</i>	<i>Idarnes</i> 'sensu stricto' ‡	38	0 (0)	0 (0)	0.336	—
<i>Pegoscapus</i>	<i>Idarnes</i> 'carne'	26	1 (4)	1 (4)	0.053	2
<i>Pegoscapus</i>	<i>Idarnes</i> 'flavicollis'	13	1 (8)	5 (38)	0.020	3
<i>Pegoscapus</i>	<i>Idarnes</i> 'incerta'	5	2 (40)	3 (60)	0.047	S1†
<i>Pegoscapus</i>	<i>Heterandrium</i>	14	0 (0)	0 (0)	0.186	4
<i>Pegoscapus</i>	<i>Heterandrium</i> (group A)	8	6 (75)	6 (75)	0.031	4
<i>Pegoscapus</i>	<i>Heterandrium</i> (group B)	6	0 (0)	1 (17)	0.039	4
<i>Pegoscapus</i>	<i>Aepocerus</i>	15	0 (0)	0 (0)	0.071	5
<i>Pegoscapus</i>	<i>Aepocerus</i> (group A)	5	4 (80)	4 (80)	0.010	5
<i>Pegoscapus</i>	<i>Aepocerus</i> (group B)	10	0 (0)	5 (50)	0.024	5
<i>Pegoscapus</i>	<i>Physothorax</i>	12	0 (0)	0 (0)	0.206	S2†
<i>Aepocerus</i>	<i>Physothorax</i>	26	0 (0)	2 (8)	0.079	6
<i>Aepocerus</i> (group A)	<i>Physothorax</i>	10	5 (50)	6 (60)	0.002	6
<i>Aepocerus</i> (group B)	<i>Physothorax</i>	16	6 (38)	7 (44)	0.008	6
<i>Idarnes</i> 'sensu stricto' ‡	<i>Idarnes</i> 'incerta'	10	2 (20)	2 (20)	0.024	7
<i>Idarnes</i> 'sensu stricto' ‡	<i>Heterandrium</i>	22	2 (9)	2 (9)	0.214	S3†
<i>Idarnes</i> 'sensu stricto' ‡	<i>Heterandrium</i> (group A)	9	3 (33)	3 (33)	0.015	—
<i>Idarnes</i> 'sensu stricto' ‡	<i>Heterandrium</i> (group B)	13	0 (0)	0 (0)	0.090	—
<i>Idarnes</i> 'sensu stricto' ‡	<i>Aepocerus</i>	29	7 (24)	10 (34)	0.002	8
<i>Idarnes</i> 'sensu stricto' ‡	<i>Aepocerus</i> (group A)	9	2 (22)	2 (22)	0.021	—
<i>Idarnes</i> 'sensu stricto' ‡	<i>Aepocerus</i> (group B)	24	1 (4)	1 (4)	0.061	—
<i>Idarnes</i> 'sensu stricto' ‡	<i>Physothorax</i>	20	0 (0)	0 (0)	0.337	S4†

*Does not include link between outgroups; †Figures available online; ‡ *Idarnes* 'sensu stricto' encompasses both competitor wasp groups: *I. 'carne'* and *I. 'flavicollis'*.

between *I. 'sensu stricto'* and the galler *Heterandrium* (Fig. S3, Supplementary material) was not significant ($P = 0.214$); however, when *Heterandrium* was divided into its two well-supported groups, the tests for global cospeciation were highly significant for group A ($P = 0.015$), but only marginally significant for group B ($P = 0.090$). The test between *I. 'sensu stricto'* and the galler *Aepocerus* was significant ($P = 0.002$, Fig. 8), yet when *Aepocerus* was divided into its two well-supported groups (see Fig. 8), links were significant for group A ($P = 0.021$), but only marginally significant for group B ($P = 0.061$), suggesting a host-switch followed by partial cospeciation. Finally, the global test of cospeciation between *I. 'sensu stricto'* and the parasitoid *Physothorax* was not significant ($P = 0.337$; Fig. S4, Supplementary material).

Discussion

This study is the first to thoroughly examine the phylogenies of multiple genera of New World nonpollinating fig wasps across multiple species of figs, and the first to reveal the ubiquity of host-switching and co-occurring species in multiple nonpollinating wasp genera. The global phylogeny presented in Fig. 1 does not support the placement of

all fig wasps in the monophyletic family Agaonidae, as suggested by Boucek (1988, 1993), in agreement with previous molecular work (Machado 1998; Rasplus *et al.* 1998). Taxonomy was, however, supported in the case of *Heterandrium* and *Aepocerus*, which are classified as part of subfamily Otitesellinae (Boucek 1988; Boucek 1993), although the two genera only clustered together in a poorly supported clade (Fig. 1). The finding of two genetically distinct clades within both *Heterandrium* (Fig. 4) and *Aepocerus* (Fig. 5), coupled with the rejection of monophyly by fig host species, suggests the possibility of two parallel species radiations in these two genera that may have followed patterns of species diversification in the pollinators and the competitors (Figs 2 and 3). The two *Heterandrium* and *Aepocerus* radiations we detected using DNA sequences correspond to two distinct groups with obvious differences in body size, abdomen shape, and ovipositor length (W. A. Marussich, unpublished data). These distinct species-groups are likely the product of a host-switch or duplication event followed by cospeciation, and warrant further molecular and morphological analyses and possibly reclassification as new genera or subgenera.

As predicted, host-switching is common among non-pollinating fig wasps. Two lines of evidence support this

conclusion. First, all nonpollinating wasp genera (or species-groups) examined had at least one wasp species that occurred on at least two fig hosts; *Heterandrium*, *I. 'carne'*, and *I. 'flavicollis'*, each had single wasp species that occurred across three, three, and four fig hosts, respectively (Table 1). Second, the presence of multiple wasp species per fig species appears to be quite common for most types of nonpollinator wasps in the Neotropics (Table 1), and suggests host-switching, because monophyly of all species from the same genus associated with the same fig host was strongly rejected in every case. We have yet to find multiple wasp species per fig species in *I. 'flavicollis'* or *I. 'incerta'*, but as these wasps are relatively rare on all but a few fig host species, our estimates of the prevalence of host-switching and multiple species per fig are likely conservative. Widespread host-switching among the nonpollinators is not surprising since host-switching has already been well documented in pollinators (Michaloud *et al.* 1996; Kerdelhue *et al.* 1999; Molbo *et al.* 2003). A recent study of one species of Neotropical fig, *Ficus petiolaris*, identified four distinct *Idarnes 'sensu stricto'* lineages associated with this host fig species across Baja, California and Sonora, Mexico (Bernhard *et al.* submitted). Although we sampled the same fig host species, we only observed one *Idarnes 'sensu stricto'* lineage, possibly because we only collected samples from one fig tree from the edge of its geographical range (Southern Arizona).

Despite the inferred high level of host-switching, different degrees of host-specificity were also observed in all groups of Neotropical nonpollinators. The proportion of unique, nonshared wasp species was lowest for the gallers *Aepocerus* and *Heterandrium* (0.625), intermediate for the three *Idarnes* species-groups (0.667–0.778), and highest for the pollinator, *Pegoscapus* (0.895) and the parasitoid *Physothorax* (0.889). These results fit our initial predictions that host-specificity would be more common among the pollinators, competitors, and parasitoids than the gallers, due to increased ecological constraints, especially in terms of oviposition sites. However, these conclusions should be considered preliminary because sample sizes for some wasp genera were small, especially for the galler *I. 'incerta'* and the parasitoid *Physothorax*, mainly because wasps from those genera are typically rare. Further, the proportion of unique to shared species was much higher for the pollinators than in previous studies (60% of cases with multiple species; Molbo *et al.* 2003; Machado *et al.* 2005) because our study focused mainly on the nonpollinators, and therefore only a few individual pollinators were sampled in most fig species.

By directly comparing the phylogenies of co-occurring wasp species using fig host species as a linking factor, we avoided relying on the fig phylogenies as indicative of the expected common history of each wasp group under the assumption of a long-term history of association between

host figs and their wasps. Direct comparison of wasp phylogenies has two main advantages: (1) it allows direct examination of the coevolutionary dynamics between wasp types; and (2) it is not dependent upon a well-resolved fig phylogeny. Given that recent population genetic studies have shown the occurrence of hybridization and introgression among different fig species (Parrish *et al.* 2003; Machado *et al.* 2005), less reliance on the fig phylogeny may be a major advantage as it is not clear whether a typical bifurcating phylogeny is an appropriate way to describe the history of closely-related fig hosts.

We found strong, but often conflicting, evidence of codiversification among the pollinating and nonpollinating fig wasps using three cophylogenetic software packages (Tables 2–4). TREEMAP 1.0 and TREEMAP 2.02 β have been used previously to compare the coevolution of figs and fig wasps, with conflicting results (Machado *et al.* 1996; Lopez-Vaamonde *et al.* 2001; Weiblen & Bush 2002; Jackson 2004; Machado *et al.* 2005). TREEMAP 1.0 has several shortcomings, the most important of which is that it minimizes host-switching (Page 1994; Siddall & Perkins 2003). Thus, cophylogenetic analyses of fig wasps using TREEMAP 1.0 should be viewed with caution, because host-switching is common among both pollinating and nonpollinating fig wasps. TREEMAP 2.02 β is an improvement over TREEMAP 1.0 in that it incorporates jungles, thus allowing one to find all solutions through exhaustive searches, and to incorporate host switches in the search for the best solutions. Furthermore, in TREEMAP 2.02 β there is no explicit optimality criterion; all solutions that could be optimal for some event cost scheme are presented and can be individually evaluated (Charleston 1998; Charleston & Page 2002). In addition, the number of optimal trees can be constrained by adding branch lengths and conducting a timed analysis, limiting the numbers of cospeciation events, host switches, duplications, or losses, or by changing the 'costs' of these different coevolutionary events. Nonetheless, computational constraints in TREEMAP 2.02 β , prevent analyses in which there are more than 20 links between phylogenies, and likely prevent the identification of all optimal reconstructions in many cases with less than 20 links. Another potential problem with both versions of TREEMAP is that they are completely dependent on tree topology and require fully resolved trees. If trees are not well-resolved, results can vary depending on the topology chosen for the analyses. The distance-based method, PARAFIT, although not topology dependent, has several limitations as well. Unlike TREEMAP, PARAFIT does not attempt to infer evolutionary relationships between phylogenies; it simply identifies species that have undergone cospeciation (individual links with $P < 0.05$) and species most likely to have been exposed to host-switching and sorting events ($P \gg 0.05$) (Legendre *et al.* 2002). A significant global fit probability simply suggests that the level of congruence between the two

phylogenies is not likely due to chance. As PARAFIT does not account for host-switching, and all fig wasp genera examined showed evidence of host-switching, the calculated global fit probabilities are likely conservative. Although we consider the TREEMAP results, especially for incidences of host-switching, losses, and duplications, we chose to focus mainly on the PARAFIT results to draw our main conclusions about cospeciation because PARAFIT analyses are not topology dependent, and because the results we obtained using PARAFIT seem more biologically plausible than the TREEMAP results. Interestingly, other researchers have found the exact opposite pattern when comparing TREEMAP and PARAFIT results (i.e. TREEMAP results were highly significant and biologically relevant, whereas PARAFIT results were nonsignificant except for the outgroups; e.g. Huysse & Volckaert 2005). As the quality of phylogenies is often variable, we recommend using both topology- and distance-based methods when conducting cophylogenetic analyses.

We found strong evidence of codivergence between pollinators and competitors, pollinators and gallers, competitors and gallers, and gallers and their parasitoids using PARAFIT (Table 4). Both competitor species-groups, *I. 'carne'* and *I. 'flavicollis'*, show evidence of codivergence with the pollinators (Table 4, Figs 2 and 3). These results match our prediction that physiological, ecological, and morphological constraints on competitor wasps may reduce incidences of host-switching, and may result in tightly coupled historical relationships between pollinators and their competitors. As expected, the parasitoid, *Physothorax*, did not show evidence of codivergence with the pollinators (Table 4, Fig. S2, Supplementary material), but did show evidence of codivergence with its host, *Aepocerus* (Table 4, Fig. 6), thus, supporting the hypothesis that genera with close ecological relationships, such as parasitoids and their hosts, are more likely to show parallel histories of divergence. In addition, there was also strong evidence of codivergence between the competitors (i.e. *Idarnes 'sensu stricto'*) and each of the gallers (i.e. *Idarnes 'incerta'*, *Aepocerus*, and *Heterandrium*; Figs 7 and 8, and Fig. S3, Supplementary material, respectively), as we predicted based on the observation that gallers are able to override abortion of unpollinated figs, which in turn may be made available to competitors that may not be able to use unpollinated syconia (Bronstein 1991; West *et al.* 1996; W. A. Marussich and C. A. Machado, personal observation). Both *Heterandrium* and *Aepocerus* gallers showed strong evidence of codivergence with the pollinators, but only when the two species radiations within each genus were analysed independently (Table 4, Figs 4 and 5). Further, the galler, *I. 'incerta'*, also showed evidence of codivergence with the pollinators (Table 4 and Fig. S1, Supplementary material). It is not clear what factors could explain the significant codivergence between pollinators and gallers, as the latter can use

unpollinated fruit to develop, and thus do not depend on the pollinators for completing their life cycles (Bronstein 1991; West *et al.* 1996; W. A. Marussich and C. A. Machado, personal observations). In addition, the presence of gallers in a fruit usually results in lower fitness for the pollinators sharing the same fruit (West *et al.* 1996). However, it is possible that both types of fig wasps use the same chemical cues to recognize fig hosts, and that this may constrain the range of host species a given galler uses. Alternatively, this codivergence could also be an indirect result of the observed pollinator-competitor and competitor-galler codivergences that we predicted on the basis of ecological interactions. TREEMAP 1.0 and 2.02 β both suggested that duplication and loss events, in addition to host-switching and cospeciation events, are also common between wasp groups (Tables 2 and 3). Duplication events are likely the result of successful host-switching. Loss events are harder to determine, as they may be the result of inadequate sampling; however, losses of pollinator species should have detrimental effects on the mutualism, whereas losses of nonpollinators would probably have positive effects on the mutualism.

In conclusion, despite having used a single barcoding mitochondrial locus to distinguish wasp species, we are comfortable with our inference of pervasive host-switching during the diversification of Neotropical nonpollinating wasps associated with *Urostigma Americana* figs. Previous data from pollinator wasps show that there is a perfect correlation between lineages defined on the basis of microsatellites, mitochondrial sequences, or nuclear sequences (Molbo *et al.* 2003; C. A. Machado, unpublished data). Results presented here point to the validity and utility of molecular data for the description of phylogenetic relationships among morphologically undescribed taxa, and provide strong additional evidence against the classical hypotheses of one-to-one species interactions and strict-sense coevolution in the fig-fig wasp system. Despite finding significant levels of codivergence among different wasp types using various cophylogenetic software packages, none of the tanglegrams (Figs 2–8, plus Figs S1–S4, Supplementary material) show evidence of perfect or even near perfect congruence between phylogenies. These observations of codivergence without congruence are to be expected in this system, however, as the history of divergence of this Neotropical community of fig-associated wasps is complex, and has been shaped by other events such as host-switching, duplications, and losses. Our results, coupled with recent findings in Neotropical pollinators (Molbo *et al.* 2003; Machado *et al.* 2005) and nonpollinators (Bernhard *et al.* submitted), are helping uncover a complex and more interesting picture of the history of codivergence between figs and their associated wasps, and mirror conclusions from detailed molecular studies of other mutualisms that have revealed common patterns of diffuse coevolution and

asymmetric specialization among the participants (Knowlton & Rohwer 2003; Stanton 2003; DePriest 2004; Mikheyev *et al.* 2006). From a paradigm dominated by the idea of one-to-one coevolution, we are witnessing a shift to a new paradigm of diffuse coevolution among figs and their associated wasps.

Acknowledgements

We would like to thank July Kelley and Tom Gilbert for assistance in the laboratory, Adalberto Gomez for assistance in the field, and Allen Herre for support while conducting collections in Panama. This project was supported by an NIH Postdoctoral Excellence in Research and Teaching (PERT) Fellowship from the Center for Insect Science, University of Arizona (to W.A.M.), a Supplementary Research Award from the Smithsonian Tropical Research Institute (to W.A.M.), and start-up funds from the Department of Ecology and Evolutionary Biology, University of Arizona (to C.A.M.).

References

- Anstett MC, Hossaert-McKey M, Kjellberg F (1997) Figs and fig pollinators: Evolutionary conflicts in a coevolved mutualism. *Trends in Ecology and Evolution*, **12**, 94–99.
- Bernhard KK, Stireman JO III, Machado CA, Nason JD (submitted) Host-switching and cryptic speciation in parasitic fig wasps.
- Boucek Z (1988) 6. Family Agaonidae. In: *Australian Chalcidoidea (Hymenoptera), A Biosystematic Revision of Genera of Fourteen Families, with a Reclassification of Species*, pp. 156–209. CAB International, Wallingford, UK.
- Boucek Z (1993) The genera of chalcidoid wasps from *Ficus* fruit in the New World. *Journal of Natural History*, **27**, 173–217.
- Bronstein JL (1987) maintenance of species-specificity in a neotropical fig–pollinator wasp mutualism. *Oikos*, **48**, 39–46.
- Bronstein JL (1991) The nonpollinating wasp fauna of ficus-pertusa—exploitation of a mutualism. *Oikos*, **61**, 175–186.
- Brooks DR, Dowling APG, van Veller MGP, Hoberg EP (2004) Ending a decade of deception: a valiant failure, a not-so-valiant failure and a success story. *Cladistics*, **20**, 32–46.
- Campbell B, Heraty J, Rasplus JY *et al.* (2000) Molecular systematics of the Chalcidoidea using 28S-rDNA. In: *The Hymenoptera: Evolution, Biodiversity and Biological Control* (eds Austin AD, Downton M), pp. 59–73. CSIRO Publishing, Canberra.
- Charleston MA (1998) Jungles: a new solution to the host/parasite phylogeny reconciliation problem. *Mathematical Biosciences*, **149**, 191–223.
- Charleston MA, Page RDM (2002) TREEMAP 2.0β. <http://taxonomy.zoology.gla.ac.uk/rod/treemap.html>.
- Compton SG, Hawkins BA (1992) Determinants of species richness in southern African fig wasp assemblages. *Oecologia*, **91**, 68–74.
- Condit IJ (1950) An interspecific hybrid in *Ficus*. *Journal of Heredity*, **41**, 165–168.
- Cook JM, Rasplus JY (2003) Mutualists with attitude: coevolving fig wasps and figs. *Trends in Ecology and Evolution*, **18**, 241–248.
- Cook JM, Compton SG, Herre EA, West SA (1997) Alternative mating tactics and extreme male dimorphism in fig wasps. *Proceedings of the Royal Society of London Series B-Biological Sciences*, **264**, 747–754.
- DePriest T (2004) Early molecular investigations of lichen-forming symbionts: 1986–2001*. *Annual Review of Microbiology*, **58**, 273–301.
- Gordh G (1975) The comparative external morphology and systematics of the neotropical parasitic fig wasp genus *Idarnes* (Hymenoptera: Torymidae). *University of Kansas Science Bulletin*, **50**, 389–455.
- Greeff JM, van Noort S, Rasplus JY, Kjellberg F (2003) Dispersal and fighting in male pollinating fig wasps. *Comptes Rendus Biologies*, **326**, 121–130.
- Grisson-Pige L, Bessiere JM, Hossaert-McKey M (2002) Specific attraction of fig-pollinating wasps: Role of volatile compounds released by tropical figs. *Journal of Chemical Ecology*, **28**, 283–295.
- Haine ER, Martin J, Cook JM (2006) Deep mtDNA divergences indicate cryptic species in a fig-pollinating wasp. *BMC Evolutionary Biology*, **6**.
- Herre EA (1989) Coevolution of reproductive characteristics in 12 species of new world figs and their pollinator wasps. *Experientia*, **45**, 637–647.
- Herre EA, West SA (1997) Conflict of interest in a mutualism: documenting the elusive fig wasp seed trade-off. *Proceedings of the Royal Society of London Series B-Biological Sciences*, **264**, 1501–1507.
- Herre EA, Machado CA, Bermingham E *et al.* (1996) Molecular phylogenies of figs and their pollinator wasps. *Journal of Biogeography*, **23**, 521–530.
- Hudson RR, Turelli M (2003) Stochasticity overrules the ‘three-times rule’: Genetic drift, genetic draft, and coalescence times for nuclear loci versus mitochondrial DNA. *Evolution*, **57**, 182–190.
- Huysse T, Volckaert FAM (2005) Comparing host and parasite phylogenies: Gyrodactylus flatworms jumping from goby to goby. *Systematic Biology*, **54**.
- Jackson AP (2004) Cophylogeny of the *Ficus* microcosm. *Biological Reviews*, **79**, 751–768.
- Jousselin E, Rasplus JY, Kjellberg F (2001) Shift to mutualism in parasitic lineages of the fig/fig wasp interaction. *Oikos*, **94**, 287–294.
- Jousselin E, Rasplus JY, Kjellberg F (2003) Convergence and coevolution in a mutualism: Evidence from a molecular phylogeny of *Ficus*. *Evolution*, **57**, 1255–1269.
- Jousselin E, van Noort S, Greeff JM (2004) Labile male morphology and intraspecific male polymorphism in the Philotrypesis fig wasps. *Molecular Phylogenetics and Evolution*, **33**, 706–718.
- Jousselin E, Van Noort S, Rasplus JY, Greeff JM (2006) Patterns of diversification of Afrotropical Otiteselline fig wasps: phylogenetic study reveals a double radiation across host figs and conservatism of host association. *Journal of Evolutionary Biology*, **19**, 253–266.
- Kerdelhue C, Le Clainche I, Rasplus JY (1999) Molecular phylogeny of the *Ceratosolen* species pollinating *Ficus* of the subgenus *Sycomorus* sensu stricto: Biogeographical history and origins of the species-specificity breakdown cases. *Molecular Phylogenetics and Evolution*, **11**, 401–414.
- Kerdelhue C, Rossi JP, Rasplus JY (2000) Comparative community ecology studies on old world figs and fig wasps. *Ecology*, **81**, 2832–2849.
- Knowlton N, Rohwer F (2003) Multispecies microbial mutualisms on coral reefs: the host as a habitat. *American Naturalist*, **162**, S51–S62.
- Legendre P, Desdevises Y, Bazin E (2002) A statistical test for host-parasite coevolution. *Systematic Biology*, **51**, 217–234.
- Lopez-Vaamonde C, Rasplus JY, Weiblen GD, Cook JM (2001) Molecular phylogenies of fig wasps: Partial cladogenesis of pollinators and parasites. *Molecular Phylogenetics and Evolution*, **21**, 55–71.

- Machado CA (1998) Molecular natural history of fig wasps. PhD Thesis, University of California, Irvine.
- Machado CA, Herre EA, McCafferty S, Bermingham E (1996) Molecular phylogenies of fig pollinating and non-pollinating wasps and the implications for the origin and evolution of the fig-fig wasp mutualism. *Journal of Biogeography*, **23**, 531–542.
- Machado CA, Jousset E, Kjellberg F, Compton SG, Herre EA (2001) Phylogenetic relationships, historical biogeography and character evolution of fig-pollinating wasps. *Proceedings of the Royal Society of London Series B-Biological Sciences*, **268**, 685–694.
- Machado CA, Robbins N, Gilbert MTP, Herre EA (2005) Critical review of host specificity and its coevolutionary implications in the fig/fig-wasp mutualism. *Proceedings of the National Academy of Sciences of the USA*, **102**, 6558–6565.
- Michaloud G, Carriere S, Kobbi M (1996) Exceptions to the one: one relationship between African fig trees and their fig wasp pollinators: Possible evolutionary scenarios. *Journal of Biogeography*, **23**, 513–520.
- Mikheyev AS, Mueller UG, Abbot P (2006) Cryptic sex and many-to-one coevolution in the fungus-growing ant symbiosis. *Proceedings of the National Academy of Sciences of the USA*, **103**, 10702–10706.
- Molbo D, Machado CA, Sevenster JG, Keller L, Herre EA (2003) Cryptic species of fig-pollinating wasps: Implications for the evolution of the fig-wasp mutualism, sex allocation, and precision of adaptation. *Proceedings of the National Academy of Sciences of the USA*, **100**, 5867–5872.
- Molbo D, Machado CA, Herre EA, Keller L (2004) Inbreeding and population structure in two pairs of cryptic fig wasp species. *Molecular Ecology*, **13**, 1613–1623.
- Newton LE, Lomo A (1979) The pollination of *Ficus vogelii* in Ghana. *Botanical Journal of the Linnean Society*, **78**, 21–30.
- van Noort S, Compton SG (1996) Convergent evolution of agaonine and sycoecine (Agaonidae, Chalcidoidea) head shape in response to the constraints of host fig morphology. *Journal of Biogeography*, **23**, 415–424.
- Page RDM (1994) Parallel phylogenies—reconstructing the history of host-parasite assemblages. *Cladistics*, **10**, 155–173.
- Page RDM (1995) TREE-MAP 1.0. <http://taxonomy.zoology.gla.ac.uk/rod/treemap.html>.
- Parrish TL, Koelewijn HP, van Dijk PJ, Kruijt M (2003) Genetic evidence for natural hybridization between species of dioecious *Ficus* on island populations. *Biotropica*, **35**, 333–343.
- Paterson AM, Banks J (2001) Analytical approaches to measuring cospeciation of host and parasites: through a glass, darkly. *International Journal for Parasitology*, **31**, 1012–1022.
- Patiño S, Herre EA, Tyree MT (1994) Physiological determinants of *Ficus* fruit temperature and implications for survival of pollinator wasp species—comparative physiology through an energy budget approach. *Oecologia*, **100**, 13–20.
- Pereira RAS, do Prado AP (2005) Non-pollinating wasps distort the sex ratio of pollinating fig wasps. *Oikos*, **110**, 613–619.
- Rambaut A (1996) SE-AL: Sequence Alignment Editor (version 2.0a11). <http://evolve.zoo.ox.ac.uk/>.
- Ramirez WB (1970) Host specificity of fig wasps (Agaonidae). *Evolution*, **24**, 680–691.
- Ramirez W (1994) Hybridization of *Ficus religiosa* with *F. Septica* and *F. Aurea* (Moraceae). *Revista De Biología Tropical*, **42**, 339–342.
- Ramirez W, Malavasi J (1997) Fig wasps: mechanisms of pollen transfer in Malvanthera and Pharmacosyceae figs (Moraceae). *Revista De Biología Tropical*, **45**, 1635–1640.
- Rasplus JY, Kerdelhué C, Le Clainche I, Mondor G (1998) Molecular phylogeny of fig wasps (Hymenoptera). Agaonidae are not monophyletic. *Compte Rendu de l'Académie des Sciences de Paris*, **321**, 517–527.
- Siddall ME (2004) Fallacies of false attribution: the defense of BPA by Brooks, Dowling, van Veller, and Hoberg. *Cladistics*, **20**, 376–377.
- Siddall ME (2005) Bracing for another decade of deception: the promise of Secondary Brooks Parsimony Analysis. *Cladistics*, **21**, 90–99.
- Siddall ME, Perkins SL (2003) Brooks parsimony analysis: a valiant failure. *Cladistics*, **19**, 554–564.
- Sokal RR, Rohlf JF (1995) *Biometry: the Principles and Practice of Statistics in Biological Research*, 3rd edn. W.H. Freeman, New York.
- Stanton ML (2003) Interacting guilds: moving beyond the pairwise perspective on mutualisms. *American Naturalist*, **162**, S10–S23.
- Stevens J (2004) Computational aspects of host-parasite phylogenies. *Briefings in Bioinformatics*, **5**, 339–349.
- Swofford DL (2002) PAUP*: *Phylogenetic Methods Using Parsimony (*and Other Methods)*, Version 4. Sinauer Associates, Sunderland, Massachusetts.
- Tamura K, Nei M (1993) Estimation of the number of nucleotide substitutions in the control region of mitochondrial DNA in humans and chimpanzees. *Molecular Biology and Evolution*, **10**, 512–526.
- Ware AB, Compton SG (1992) Breakdown of pollinator specificity in an African fig tree. *Biotropica*, **24**, 544–549.
- Weiblen GD (2000) Phylogenetic relationships of functionally dioecious *Ficus* (Moraceae) based on ribosomal DNA sequences and morphology. *American Journal of Botany*, **87**, 1342–1357.
- Weiblen GD (2001) Phylogenetic relationships of fig wasps pollinating functionally dioecious *Ficus* based on mitochondrial DNA sequences and morphology. *Systematic Biology*, **50**, 243–267.
- Weiblen GD, Bush GL (2002) Speciation in fig pollinators and parasites. *Molecular Ecology*, **11**, 1573–1578.
- West SA, Herre EA (1994) The ecology of the new-world fig-parasitizing wasps *Idarnes* and implications for the evolution of the fig-pollinator mutualism. *Proceedings of The Royal Society of London Series B-Biological Sciences*, **258**, 67–72.
- West SA, Herre EA, Windsor DM, Green PRS (1996) The ecology and evolution of the New World non-pollinating fig wasp communities. *Journal of Biogeography*, **23**, 447–458.
- Wiebes JT (1979) Co-evolution of figs and their insect pollinators. *Annual Review of Ecology and Systematics*, **10**, 1–12.
- Yokoyama J (2003) Cospeciation of figs and fig-wasps: a case study of endemic species pairs in the Ogasawara Islands. *Population Ecology*, **45**, 249–256.
- Zammit J, Schwarz MP (2000) Intersexual sibling interactions and male benevolence in a fig wasp. *Animal Behaviour*, **60**, 695–701.

Wendy Marussich is an evolutionary ecologist interested mutualisms, coevolution, phylogenetics, and trophic dynamics. Her main research areas are the fig/fig wasp mutualism, myrmecochory between ants and *Datura*, and effects of urbanization on trophic dynamics of arthropods. Carlos A. Machado is an evolutionary geneticist interested in population genetics, phylogenetics, plant-insect coevolution, and the genetic basis of speciation in insects. His main research systems are *Drosophila* and the fig/fig wasp mutualism.

Supplementary material

The following supplementary material is available for this article:

Fig. S1 Tanglegram comparing maximum likelihood (ML) trees of fig pollinators (*Pegoscapus*) and *Idarnes 'incerta'* galls. Lines linking taxa are based on fig host species. Bootstrap values (> 50%) based on 1000 NJ replicates are indicated. Bold lines indicate significant links between taxa (PARAFIT, $P < 0.05$), and dashed lines indicate marginally significant links between taxa (PARAFIT, $P < 0.1$).

Fig. S2 Tanglegram comparing maximum likelihood (ML) trees of fig pollinators (*Pegoscapus*), and *Physothorax*, parasitoid of *Aepocerus* galls. Lines linking taxa are based on fig host species. Bootstrap values (> 50%) based on 1000 NJ replicates are indicated. Bold lines indicate significant links between taxa (PARAFIT, $P < 0.05$), and dashed lines indicate marginally significant links between taxa (PARAFIT, $P < 0.1$).

Fig. S3 Tanglegram comparing maximum likelihood (ML) trees of *Idarnes 'sensu stricto'* competitors and one group of galls (*Heterandrium*). Lines linking taxa are based on fig host species. Bootstrap values (> 50%) based on 1000 NJ replicates are indicated. *Heterandrium* phylogeny is split into two well-supported clades, A and B, for further analysis. Bold lines indicate significant links between taxa (PARAFIT, $P < 0.05$).

Fig. S4 Tanglegram comparing maximum likelihood (ML) trees of *Idarnes 'sensu stricto'* competitors, and *Physothorax*, parasitoid of *Aepocerus* galls. Lines linking taxa are based on fig host species. Bootstrap values (> 50%) based on 1000 NJ replicates are indicated. Bold lines indicate significant links between taxa (PARAFIT, $P < 0.05$), and dashed lines indicate marginally significant links between taxa (PARAFIT, $P < 0.1$).

Table S1 Pairwise Tamura-Nei distances for four species of wasps from each of the six nonpollinator groups plus one pollinator and two outgroup taxa. Sequences are available from GenBank (Accession numbers: EF158858-EF159145).

Table S2 Probabilities computed by PARAFIT (999 permutations) using pairwise Tamura-Nei distances between the competitors (*Idarnes 'sensu stricto'*) and their corresponding pollinators (*Pegoscapus*). The null (H_0) hypothesis for the global test (bottom of table) is that competitors are randomly associated with pollinators (i.e. they did not cospeciate). For tests of individual competitor-pollinator association links, the null hypothesis is that the links are random.

Table S3 Probabilities computed by PARAFIT (999 permutations) using pairwise Tamura-Nei distances between the competitors (*Idarnes 'carne'*) and their corresponding pollinators (*Pegoscapus*). The null (H_0) hypothesis for the global test (bottom of table) is that the competitors are randomly associated with pollinators (i.e. they did not cospeciate). For tests of individual competitor-pollinator association links, the null hypothesis is that the links are random.

Table S4 Probabilities computed by PARAFIT (999 permutations) using pairwise Tamura-Nei distances between competitors (*Idarnes 'flavicollis'*) and their corresponding pollinators (*Pegoscapus*). The null (H_0) hypothesis for the global test (bottom of table) is that

competitors are randomly associated with pollinators (i.e. they did not cospeciate). For tests of individual competitor-pollinator association links, the null hypothesis is that the links are random.

Table S5 Probabilities computed by PARAFIT (999 permutations) using pairwise Tamura-Nei distances between the galls (*Idarnes 'incerta'*) and their corresponding pollinators (*Pegoscapus*). The null (H_0) hypothesis for the global test (bottom of table) is that galls are randomly associated with pollinators (i.e. they did not cospeciate). For tests of individual competitor-pollinator association links, the null hypothesis is that the links are random.

Table S6 Probabilities computed by PARAFIT (999 permutations) using pairwise Tamura-Nei distances between: **A.** all galls (*Heterandrium*) and their corresponding pollinators (*Pegoscapus*), **B.** galls (*Heterandrium*) from group A and their corresponding pollinators (*Pegoscapus*), and **C.** galls (*Heterandrium*) from group B and their corresponding pollinators (*Pegoscapus*). The null (H_0) hypothesis for the global test (bottom of table) is that the galls are randomly associated with the pollinators (i.e. they did not cospeciate). For tests of individual galler-pollinator association links, the null hypothesis is that the links are random.

Table S7 Probabilities computed by PARAFIT (999 permutations) using pairwise Tamura-Nei distances between: **A.** galls (*Aepocerus*) and their corresponding pollinators (*Pegoscapus*), **B.** galls (*Aepocerus*) from Group A and their corresponding pollinators (*Pegoscapus*), and **C.** galls (*Aepocerus*) from Group B and their corresponding pollinators (*Pegoscapus*). The null (H_0) hypothesis for the global test (bottom of table) is that competitors are randomly associated with the pollinators (i.e. they did not cospeciate). For tests of individual galler-parasitoid association links, the null hypothesis is that the links are random.

Table S8 Probabilities computed by PARAFIT (999 permutations) using pairwise Tamura-Nei distances between gall parasitoids (*Physothorax*) and their corresponding pollinators (*Pegoscapus*). The null (H_0) hypothesis for the global test (bottom of table) is that the gall parasitoids are randomly associated with the pollinators (i.e. they did not cospeciate). For tests of individual galler-pollinator association links, the null hypothesis is that the links are random.

Table S9 Probabilities computed by PARAFIT (999 permutations) using pairwise Tamura-Nei distances between: **A.** galls (*Aepocerus*) and their corresponding parasitoids (*Physothorax*), **B.** galls (*Aepocerus*) from Group A and their corresponding parasitoids (*Physothorax*), and **C.** galls (*Aepocerus*) from Group B and their corresponding parasitoids (*Physothorax*). The null (H_0) hypothesis for the global test (bottom of table) is that the parasitoids are randomly associated with the galls (i.e. they did not cospeciate). For tests of individual galler-parasitoid association links, the null hypothesis is that the links are random.

Table S10 Probabilities computed by PARAFIT (999 permutations) using pairwise Tamura-Nei distances between the galls (*Idarnes 'incerta'*) and their corresponding competitors (*Idarnes 'sensu stricto'*). The null (H_0) hypothesis for the global test (bottom of table) is that the galls are randomly associated with the competitors (i.e. they did not cospeciate). For tests of individual galler-competitor association links, the null hypothesis is that the links are random.

Table S11 Probabilities computed by PARAFIT (999 permutations) using pairwise Tamura–Nei distances between: **A.** all gallers (*Heterandrium*), **B.** gallers (*Heterandrium*) from group A, and **C.** gallers (*Heterandrium*) from group B, and their corresponding competitors (*Idarnes 'sensu stricto'*). The null (H_0) hypothesis for the global test (bottom of table) is that the gallers are randomly associated with the competitors (i.e. they did not cospeciate). For tests of individual galler–competitor association links, the null hypothesis is that the links are random.

Table S12 Probabilities computed by PARAFIT (999 permutations) using pairwise Tamura–Nei distances between: **A.** all gallers (*Aepocerus*), **B.** gallers (*Aepocerus*) from group A, and **C.** gallers (*Aepocerus*) from group B, and their corresponding competitors (*Idarnes 'sensu stricto'*). The null (H_0) hypothesis for the global test (bottom of table) is that the gallers are randomly associated with the competitors (i.e. they did not cospeciate). For tests of individual galler–competitor association links, the null hypothesis is that the links are random.

Table S13 Probabilities computed by PARAFIT (999 permutations) using Tamura–Nei distances for gall parasitoids (*Physothorax*) and competitors (*Idarnes 'sensu stricto'*). The null (H_0) hypothesis for the global test (bottom of table) is that the gall parasitoids are randomly associated with the competitors (i.e. they did not cospeciate). For tests of individual gall parasitoid–competitor association links, the null hypothesis is that the links are random.

This material is available as part of the online article from:
<http://www.blackwell-synergy.com/doi/abs/10.1111/j.1365-294X.2007.03278.x>

(This link will take you to the article abstract).

Please note: Blackwell Publishing are not responsible for the content or functionality of any supplementary materials supplied by the authors. Any queries (other than missing material) should be directed to the corresponding author for the article.