

MICHAEL H. ROBINSON
and JOSÉ OLAZARRI

*Units of Behavior and
Complex Sequences in
the Predatory Behavior
of *Argiope argentata*
(Fabricius):
(Araneae: Araneidae)*

SERIAL PUBLICATIONS OF THE SMITHSONIAN INSTITUTION

The emphasis upon publications as a means of diffusing knowledge was expressed by the first Secretary of the Smithsonian Institution. In his formal plan for the Institution, Joseph Henry articulated a program that included the following statement: "It is proposed to publish a series of reports, giving an account of the new discoveries in science, and of the changes made from year to year in all branches of knowledge." This keynote of basic research has been adhered to over the years in the issuance of thousands of titles in serial publications under the Smithsonian imprint, commencing with *Smithsonian Contributions to Knowledge* in 1848 and continuing with the following active series:

Smithsonian Annals of Flight
Smithsonian Contributions to Anthropology
Smithsonian Contributions to Astrophysics
Smithsonian Contributions to Botany
Smithsonian Contributions to the Earth Sciences
Smithsonian Contributions to Paleobiology
Smithsonian Contributions to Zoology
Smithsonian Studies in History and Technology

In these series, the Institution publishes original articles and monographs dealing with the research and collections of its several museums and offices and of professional colleagues at other institutions of learning. These papers report newly acquired facts, synoptic interpretations of data, or original theory in specialized fields. These publications are distributed by subscription to libraries, laboratories, and other interested institutions and specialists throughout the world. Individual copies may be obtained from the Smithsonian Institution Press as long as stocks are available.

S. DILLION RIPLEY
Secretary
Smithsonian Institution

SMITHSONIAN CONTRIBUTIONS TO
ZOOLOGY

NUMBER 65

*Michael H. Robinson
and José Olazarri*

Units of Behavior and
Complex Sequences in
the Predatory Behavior
of *Argiope argentata*
(Fabricius):
(Araneae: Araneidae)

SMITHSONIAN INSTITUTION PRESS

CITY OF WASHINGTON

1971

ABSTRACT

Michael H. Robinson and José Olazarri. Units of Behavior and Complex Sequences in the Predatory Behavior of *Argiope argentata* (Fabricius): (Araneae: Araneidae). *Smithsonian Contributions to Zoology*, number 65, 36 pages, 1971—An experimental and observational study of the predatory behavior of *Argiope argentata*, a large orb-web spider, is reported in detail. The predatory behavior consists of a sequence of distinct behavior units. The sequence begins when the prey strikes the web and ends when the spider starts feeding or the prey escapes. Detailed description of all the behavior units that are known to be employed in predatory sequences are given. The units are functionally distinct and involve prey location, prey discrimination, prey immobilization, and prey transportation.

Predatory sequences vary both in the units of behavior involved and in the duration of these units. Complete behavior sequences are described and analyzed. These sequences were given by adult spiders when they were presented with seven types of insect prey that differed taxonomically and/or physically. Further studies were made of the responses of spiders to both inedible artifacts and naturally occurring inedible objects.

An extensive comparison is made of the sequences elicited by different types of prey and conclusions are drawn about the adaptive significance of the various attack and restraint strategies. The model of the predatory behavior of *A. argentata* proposed by Robinson (1969) is revised and recast. A picture of considerable complexity emerges from this study.

Special publication date is handstamped in a limited number of initial copies and is recorded in the Institution's annual report, Smithsonian Year.

UNITED STATES GOVERNMENT PRINTING OFFICE
WASHINGTON : 1971

For sale by the Superintendent of Documents, U.S. Government Printing Office
Washington, D.C. 20402 - Price 45 cents (paper cover)

Contents

	<i>Page</i>
Introduction	1
Materials and Methods	1
Terminology	3
Classification of Behavior Units	4
Description of Behavior Units	5
Plucking	5
Wrapping	6
Biting	11
Cutting Out	11
Pulling Out	12
Transportation	13
Attachment of Prey to the Hub	13
Prefeeding Food Manipulation	13
Rest Stages and Grooming Activities	14
Defecation	14
Drinking	14
Description and Analysis of Behavior Sequences	14
General	14
Behavior Sequences with Live Crickets as Prey	15
Behavior Sequences with Live Moths as Prey	18
Behavior Sequences with Dead Moths as Prey	19
Behavior Sequences with Live Pentatomids as Prey	19
Behavior Sequences with Live Dragonflies as Prey	20
Behavior Sequences with Live <i>Trigona</i> sp. as Prey	21
Behavior Sequences Given to Live Flies	22
Behavior Sequences Elicited by Presentation of Artifacts	23
Behavior Sequences Given to Plant Material	24
Comparison of Behavior Sequences Elicited by Different Types of Prey	25
Sequences Initiated by the Wrap/Bite Attack Couplet	25
Sequences Initiated By the Bite/Wrap Attack Couplet	28
Sequences Initiated by the Seize/Pullout Attack Couplet	29
Discussion	29
The New Model	29
Internal Factors and Predatory Sequences	32
Adaptive Aspects of the <i>Argiope argentata</i> Predatory Sequences	33
Relations with Other Spiders	34
Problems for Further Investigation	35
Summary	35
Acknowledgments	35
Bibliography	35

Michael H. Robinson
and José Olazarri

Units of Behavior and Complex Sequences in the Predatory Behavior of *Argiope argentata* (Fabricius): (Araneae: Araneidae)

Introduction

Argiope argentata (Fabricius) is a fairly large, strikingly patterned (Figure 1) orb-web spider which is widely distributed in Central and South America (Levi, 1968). It is a spider of forest clearings, forest margins, and grassland edges, and is almost entirely diurnal in activity. An experimental analysis of some aspects of the predatory behavior of *A. argentata* has been reported by Robinson (1969). The present paper is concerned with the description and analysis of complex behavior sequences in the predatory behavior of *A. argentata* and also, for the first time, gives detailed descriptions of the behavioral units that make up these sequences. Previous workers on the predatory behavior of orb-web spiders, particularly Peters (1931, 1933a, 1933b), have emphasized the fact that prey capture consists of sequences of distinct behavioral elements and that these sequences may vary both in the order and composition of the behaviors involved. Surprisingly, such previous reports do not include quantified observations on complete behavior se-

Michael H. Robinson, Smithsonian Tropical Research Institute, P.O. Box 2072, Balboa, Canal Zone (Panama).
José Olazarri, Departamento de Zoología, Museo Nacional de Historia Natural, Casilla de Correo 399, Montevideo, Uruguay.

quences, and the descriptions of the sequences are, in the main, built up synthetically from studies of sub-sequences.

Our observations on large numbers of complete sequences reveal that there are interesting variations in the predatory behavior elicited by various types of prey. We have also found that there are variations within the sequences of behavior given to the same type of prey and that these may be both complex and revealing. Since this study was completed the senior author and his co-workers have made similar studies of the predatory behavior of other tropical and temperate orb-web spiders, and reference is made to the results of these studies wherever a comparison has been of value in elucidating aspects of our work.

Materials and Methods

All our studies were carried out at the Barro Colorado Island research station of the Smithsonian Tropical Research Institute. Investigations were entirely restricted to adult female spiders which were collected on Barro Colorado Island, from other areas in the Canal Zone, and from localities in the Republic of Panama. All the captive spiders involved in the study were housed in screened cages inside a large screened insectary. In these conditions the spiders were subject



FIGURE 1.—Adult female *Argiope argentata* feeding, at hub, on a moth. Note that the legs are held in a cruciform attitude and that the prey package hangs below the spider. The spider is on the under surface of the inclined web and is seen in dorsal aspect. Size of body, about 28 mm.

to ambient temperatures closely corresponding to those prevailing in the region and to a natural humidity regime. They were not exposed to direct sunlight or to rainfall. The screened cages ensured that the spiders could be maintained on a controlled food regime. We also conducted observations and experiments on free-living spiders in the laboratory clearing at Barro Colorado.

The insects that were used as prey were either caught in the natural habitat of the spider, or purchased (in the case of domestic crickets). Our choice of prey types for use in the extensively replicated observations was determined by two factors. First we wanted to observe the behavior sequences that were elicited by the most important types of natural prey, and also we were anxious to compare the sequences given to prey types which were either known to elicit markedly different initial responses or for which we had good reason to predict response differences. In determining important categories of natural prey we took advantage of a study of the prey caught by *A. argentata* on Barro Colorado Island (Robinson and Robinson, 1970). This study showed that, by number, the most common prey were stingless bees of the genus *Trigona*, and that these were followed by insects of the orders Orthoptera, Coleoptera, Hemiptera, Lepidoptera, Diptera, and Odonata in descending order. Our selection of prey types from this list of natural importance was influenced by the second consideration mentioned above. Thus the initial response to lepidopterans differs markedly from that given to most other types of prey (Robinson, 1969). We therefore decided to concentrate the first studies on behavior sequences involving lepidopterans and orthopterans. Peters (1931) reported that the orb-web spider *Araneus diadematus* (L.) responded differentially to vibrating flies compared with nonvibrating insects. For that reason it seemed worth investigating the behavior sequences given to flies by *A. argentata*. We also investigated the behavior sequences given to pentatomids (Hemiptera), since these are not only an important natural prey item but also produce a chemical defense which could possibly influence the spiders' predatory behavior. Responses to dragonflies (Odonata) were studied because these insects struggle very powerfully in the web and hence might be expected to induce variations in predatory behavior sequences.

In the case of some prey types (detailed in the descriptive section) we made separate studies of the behavior sequences given to living and dead insects. In these experiments the dead insects were always killed by freezing so as to avoid chemical contamination.

The number of sequences studied with respect to any one prey depended to some extent on the availability of the insect, but was never less than fifty. In the case of lepidopterans we used a variety of cryptic moths collected at night. No one moth species (or even genus) was available in sufficient quantities to be used exclusively, and this may be a factor contributing to variability in sequential behavior. Domestic crickets were used extensively as the orthopteran prey. The flies, pentatomids, stingless bees, and dragonflies were not identified. Of each of these groups, the insects that we used were assumed—on the basis of gross morphology—to be of the same species or at least closely related. All the insects were weighed before use and their length and/or wingspan measured.

Behavior sequences were recorded on specially prepared data sheets. On these all the known behavior units were preprinted so that it was only necessary to connect these in the observed order of occurrence and simultaneously note the duration of each unit. The data sheets also served to record the prey type, weight, length, spider number, and the state of the web prior to the observation. Initially we timed the behavior units with a stopwatch, but later used a Rustrak multichannel chart recorder.

Films were made of all the behavior units, as given to a variety of types of prey, and these were analyzed on a Bell and Howell movement analysis projector. The descriptions of behavior units are based both on direct observation and motion picture analysis. Illustrations of behavior units have been prepared by tracing single frames from our research films. The films are deposited with the library of the Smithsonian Tropical Research Institute.

Terminology

The terminology used in describing the stages in predatory behavior, and the behavioral units involved, is defined in the following pages and follows the usage of Robinson (1969). The terminology used to describe the structure of the orb web is given in Figure 2. Where there are differences between American and

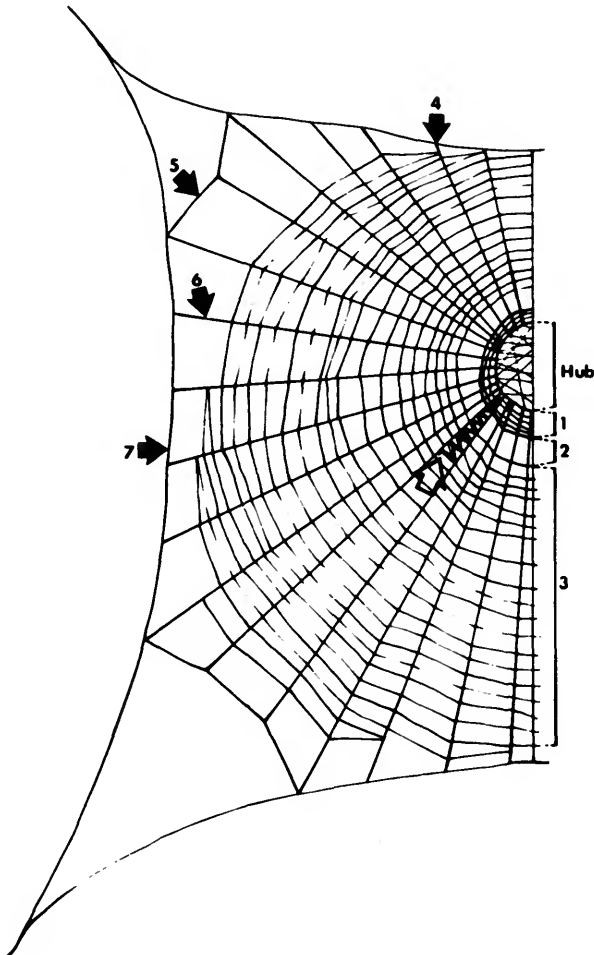

FIGURE 2.—Diagram of orb web. Key to nomenclature gives American and English terminology: 1, Attachment zone K, strengthening zone S. 2, Free zone K and S. 3, Spiral zone K, trapping zone S. 4, Upper foundation thread (bridge) K, bridge thread S. 5, (Inner) foundation line of second order K, section thread S. 6, Radius K and S. 7, Foundation line of first order (outer foundation line) K, frame thread S. (American terms marked K, from Kaston and Kaston 1952. English terms S, from Savory 1952.) The open arrow marks the position of the stabilimentum.

English usage in these terms, both terms are given on the figure and are used interchangeably in the text. Anatomical and morphological terms are used in the conventional sense(s). Legs are designated either by the use of Roman numerals or as first leg, second leg, etc. The term “jaw” is used interchangeably with the

more precise term “chelicera,” and the word “fang” is used to refer to the pointed terminal (distal) segment of the chelicera. We have also used the terms cephalothorax and abdomen interchangeably with the more general terms prosoma and opisthosoma. “Drag line” is used to refer to the silk line which the spider produces as it moves about the surface of the web. The expression “prey package” is used to describe prey that have been parcelled in silk and removed from the web. Prey is used both as a singular and plural noun.

Classification of Behavior Units

Robinson (1969) gave a functional classification of the behavior units involved in the predatory behavior of *A. argentata*. This is repeated here, in an expanded form, as a framework for the descriptions of both units and sequences. The units can be conveniently regarded as belonging to five functional categories. These are:

1. Prey location. Consisting of the location of the prey within the web area.
2. Prey discrimination. Consisting of discrimination between taxonomically different types of prey and/or between prey in different states of activity, etc.
3. Prey immobilization. Consisting of prey immobilization by biting and enswathing in silk, or simply biting.
4. Prey transportation. Consisting of the transportation of the prey from the capture site to the feeding site. Involving, as accessory stages, removal of the prey from the web at the capture site and its attachment to the web at the feeding site.
5. Feeding. Consisting of the prefeeding manipulation of the prey at the feeding site and the complex of feeding activities.

Categories 1 and 2 can be regarded as functioning to ensure that the prey is attacked rapidly and with the appropriate attack strategy or weapon. The behaviors in category 3 function to prevent the escape of the prey but may also facilitate prey transportation. Prey transportation may enable the spider to feed at a site from which it can most efficiently monitor the web or (in spiders that build a retreat) from which it can monitor the web while remaining concealed from potential predators. Attachment of the prey at the

feeding site may enable the spider to make further attacks on prey without losing existing prey. Thus categories 3 and 4 may be multifunctional, although a primary function seems probable and is assumed.

The location of prey does not involve any conspicuous overt change in the spider's behavior, although a special behavior, "plucking," which may be involved in prey location, occurs most frequently if the prey is immobile after striking the web (Robinson 1969). We have ignored prey location in our descriptions of behavior sequences. The behavior involved in discrimination between prey types is not certainly identified, although touching the prey with the tarsi, and sometimes with the pedipalps, occurs before most attacks are initiated and may represent one stage in the discriminatory process. Again we have ignored this behavior in our descriptions of behavior sequences (but see Robinson, 1969). In the case of *A. argentata*, immobilization is achieved by the employment of behavior couplets where two behavior units are firmly but not invariably associated. Thus biting and wrapping in silk are usually employed in conjunction. The order of involvement of these two behaviors is of considerable interest. In general, lepidopterans are first attacked by biting and are then quickly wrapped, whereas most other insects are attacked by wrapping and then bitten. Some small prey are seized in the jaws and pulled from the web, and are not wrapped until after transportation. Some araneid spiders appear to use biting as an invariable initial means of attack—this is not closely associated with wrapping (as it is in the *A. argentata* attack couplets). *Nephila clavipes* (L) is a spider which attacks all types of prey by biting (Robinson and Mirick, in preparation).

During or after the prey immobilization process, the spider may stand on the prey and perform grooming activities or remain motionless. We have designated this stage as "rest on prey," and in our observations recorded such a behavior whenever the duration was more than ten seconds. This time, chosen arbitrarily, seems to provide a realistic basis for distinguishing between pauses in attack behavior and a separate and distinct stage. After prey immobilization the spider may return to the hub for a variable period of time before returning to the prey and carrying it back to the hub. This period, during which the spider assumes a predatory position and will attack further prey, we call "rest at hub." There is no confusion between this behavior and the behavior by which the

spider may attach a silk line from the prey to the hub, because when rest at hub occurs the spider adopts a head-down position at the hub and arranges its legs in a typical cruciform attitude (Figure 1). The rest-at-hub stage is strongly associated with behavior sequences in which the prey is attacked by the wrap/bite couplet. The first stage in the commencement of transportation is usually marked by the spider's cutting the prey package from the web. Once the prey, or the prey package, is freed from the web it is carried to the hub by the spider. All forms of carrying behavior (described in the following section) are designated "carry" on our diagrams of behavior sequences. Once at the hub the spider may wrap, or rewrap, the prey in silk before attaching it to the web (wrap at hub). Alternatively it may simply attach an already wrapped prey to the hub. Wrap at hub may be preceded by a stage when the spider assumes a head-down posture—this stage we designate on our diagrams as "rest." A rest stage may follow wrapping at the hub and precede food manipulation. Operationally this rest stage is distinguished as being a phase when the spider is neither wrapping nor manipulating the prey. Eventually, and most frequently, the spider starts the "manipulation" of the food which usually precedes feeding. When the spider takes all its legs off the prey and assumes a cruciform position with the food in its jaws, it is regarded as being at the "feeding" stage.

Description of Behavior Units

The following descriptions of behavior units are based on a large number of observations and the careful frame-by-frame analysis of movies of the behaviors concerned. This latter technique is particularly useful since it enables rapid and visually confusing processes to be slowed down and their components can then be distinguished.

PLUCKING

Plucking is normally carried out with legs I. After prey has struck the web, the spider at the hub orients toward the general direction of the prey and, after plucking, moves toward the prey along the appropriate radii. It thereafter may pause and pluck several times during the approach to the prey. The process does not always occur and is particularly marked in circum-

stances when the prey does not struggle or vibrate after striking the web. The spider may pluck only those radii in the sector of the web where the prey is located, which is usually the case. In certain circumstances, however, the spider may turn through as much as 360° and pluck radii at intervals as it turns. We have seen this type of plucking apparently in response to sudden wind-induced web movements and also to moving contacts between vegetation and the web. Plucking that is confined to radii in the sector where prey impact has occurred is often repeated on different radii in that region until the spider has apparently located the radius (or radii) on which the prey is lying (or to which the portion of the viscid spiral holding the prey is attached). If the prey is above the spider, or above the equator of the web, the spider usually turns toward the sector where the prey is located before plucking. This fact suggests that prey location is not entirely dependent on the effects of plucking, even in the situations where the prey is immobile. Some workers have suggested that plucking serves to induce inactive prey to move and is thus a means of testing whether an object in the web is alive or dead (McCook 1889, p. 249). We are inclined to believe that it is a method of locating prey that is not dependent on inducing the prey to move. If a dead insect is thrown into the web and the spider moves toward it after plucking, the spider will turn back after the next plucking attempt if the prey is quickly removed from the web between the two plucking movements. If the prey remains in situ, the spider's movement toward it frequently accelerates after approach-plucking. In the first case, cessation of approach could be due to a perception of the resulting change in tension on the radii involved. The second case is more difficult to explain. It seems possible that plucking may transmit vibrations to unmoving objects and that these may return to the spider along the plucked radii and form a basis for discriminating between those radii with a prey load and those without.

In the case of vibrating or otherwise moving prey, the pluck stage may be omitted simply because the spider can make a precise location, after turning toward the appropriate sector, on the basis of prey-induced vibrations.

The movement involved in plucking is a flexion of the anterior legs. The legs are flexed with their tarsi in continuous contact with the radii. The effect

of the movement is to produce a sharp jerk on the radius. This jerk is certainly transmitted to any object lying on, or close to, the radius involved. The two legs I appear to pluck two adjacent radii simultaneously, although during approach plucking only one leg I may be used.

Some spiders, including *Nephila clavipes*, but not *Argiope argentata*, perform plucking movements after returning to the hub with the prey. The spider then turns to each side of the perpendicular midline of the web and plucks radii as it moves. This behavior is again suggestive of a prey-location process. Thus, it seems possible that prey impacts that occur while the spider is engaged in prey-capture activities may not be detected at the time, and plucking at the hub, on return, may result in the location of any prey which have been trapped during the period of absence from the hub. *Argiope savignyi* Levi, and some other *Argiope* spp., perform a further, and very distinctive, type of movement after returning from a prey-capture site. This consists of a slow and "deliberate" flexion of all eight legs, which is carried out with the tarsi in contact with radii and the legs spread. All the radii on which the legs are resting are slowly pulled as a consequence of this behavior and are then, just as slowly, allowed to recoil. The function of this movement is problematical, but it is one of the few conspicuous behavioral differences between *A. argentata* and *A. savignyi*.

WRAPPING

As noted above, and by Robinson (1969), wrapping may occur at several stages in the prey-capture process. It may be the initial means of restraint applied to the prey (immobilization wrapping), or it may occur after the immobilization bite and before the prey has been removed from the web. In addition, wrapping of the prey may occur during transportation and also after arrival at the hub.

An extensive account of the functional aspects of wrapping by araneid spiders is given by Robinson, Mirick, and Turner (1969).

Wrapping as an initial means of attack (and restraint) differs from postattack wrapping in that it includes a conspicuous component which Robinson (1969) called "throwing." The movements involved in throwing occur in all forms of wrapping but differ markedly in their intensity and orientation. Con-

spicuous throwing movements occur most frequently in wrapping attacks on large or heavy prey. Throwing involves the spider's casting swathes of silk over the prey and partially onto the web surface. In *A. argentata* the spider usually throws as it stands facing away from the hub. It may stand at the side of the prey closest to the hub, on the prey, or at the side away from the hub. In other araneids, particularly in *Eriophora* sp., the spider contacts the prey and then turns through 180° before initiating throwing movements. This turning to face the hub, and away from the prey, occurs only in special circumstances in the behavior of *A. argentata*. Thus if the prey struggles to the edge of the web and hangs by a few stretched web members, or dangles below the web on a stretched element of the viscid spiral, the spider will descend to the prey and turn away from it before throwing. In throwing, the spider pulls swathes of silk from its spinnerets by using the tarsi of its fourth legs. The multistrand silk swathe issues from the spinnerets in a narrow band but is expanded into a broad sheet by the leg movements. The legs then cast the broad swathe over the prey. If the spider stands in front of the prey, the leg movements are directed forward beneath the body; this type of throwing is normally confined to small prey (e.g., stingless bees). If the spider is standing on or behind the prey, the silk is cast downward or slightly backward. The effect of the series of throwing movements is to sandwich the prey against the surface of the web beneath a sheet of thrown silk. If the prey is suspended on a few threads below the web surface or at the bottom of the web, throwing tends to envelope the prey in silk and to reinforce the perhaps tenuous attachment to the web lines.

A spider may reach a large struggling insect and commence throwing, but then be faced with a situation in which the prey slips down the web toward its margin. In these cases the progress of the falling prey may be marked by a series of separate throwing bouts, each initiated as the spider pursues the prey down the web. As this takes place, the spider may turn to face the hub and, from above, throw silk backward onto the prey. This suggests that forward throwing may be possible only if the spider is able to stand on a plane surface while throwing. (The other circumstances in which *A. argentata* regularly faces away from the prey when throwing, as previously detailed, are also ones in which the spider

cannot stand on an intact web surface or the prey.) After the pursuit of dropping prey we have seen the spider and its prey finish up at the end of a large, perpendicularly elongate, hole in the web.

The throwing stage is not always very distinct. Once the tarsi of legs IV move close to the margin of the prey, throwing merges imperceptibly into the next stage of the process, as silk swathes are directed onto the prey, rather than over it, onto the web surface. Similarly, in postimmobilization wrapping (after immobilization biting in the attack on lepidopterans), silk is thrown onto the body or wing surfaces, rather than over them onto the web surface. This may be the simple consequence of the relatively large surface area of these insects.

As throwing progresses and the movements of legs IV bring the tarsi closer and closer to the prey, pushing silk against it, the prey usually starts to revolve. The spider has by then oriented itself at right angles to the long axis of the prey, and the rotation induced in the prey is thus, almost always, an axial rotation. This rotation may take place about "axles" of adhering web members at each end of the prey, and these may consist of several strands of silk wound into a tight unit as the rotation points. Sometimes the tarsi of the short third legs appear to act as points about which the rotation occurs. The rotation appears to be induced by the force exerted against the lower edge of the prey by the moving hind legs and is thus a movement toward the spider's anterior. Legs I and II of the spider are usually hooked over the upper surface of the prey and make forward "walking" movements as the prey revolves. Prey rotation may thus be a consequence of the rearward forces that these legs could exert in their walking movements. The whole effect of the rotation is similar to that of silk being wound onto a bobbin or of line being wound onto a fishing reel. As rotation proceeds, the throwing movements of legs IV cease and silk is wound directly onto the prey from the spinnerets. At this stage legs IV may continue to move against the prey but do not pick up silk from the spinnerets and carry it forward. (It seems reasonable to suppose that as throwing ceases, the principal forces producing rotation may be transferred to legs I and II.)

In the early stages of throwing, both legs IV pick up silk and cast it in nearly synchronous movements. As throwing progresses and merges into prey-rotation wrapping, the movements of the left and right legs

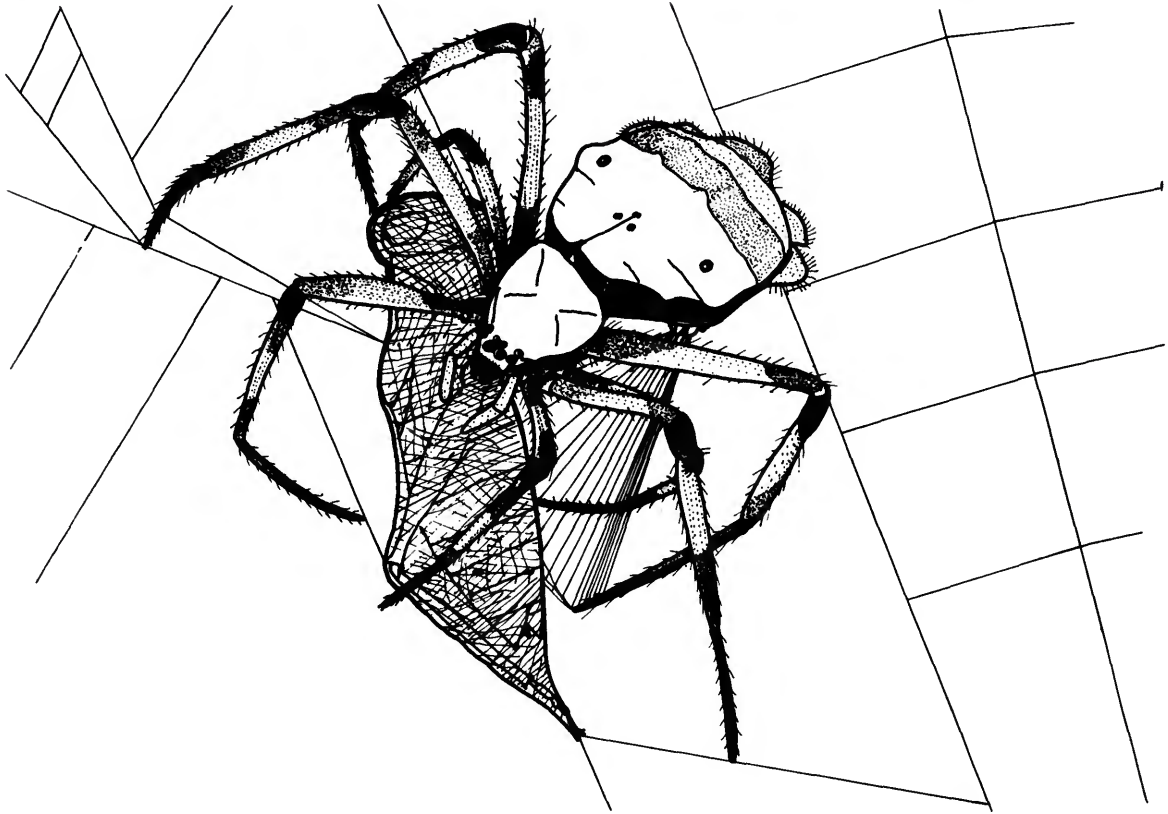

FIGURE 3.—*A. argentata* wrapping a domestic cricket. Note the fan of silk being pulled from the spinnerets by the left leg IV. The pedipalps are in contact with the surface of the prey package. (Drawn from a frame of 16 mm movie film.)

become conspicuously out of phase and the effect is of bicycling. In the case of the spider, *Nephila clavipes*, where wrapping occurs only after the prey has been bitten, the bicycling movements are slow and easily counted.

Figure 3 shows *A. argentata* at the prey-rolling stage, when throwing movements are still occurring, Figure 4 shows the direction of prey rotation in relation to the spider.

At the stage when silk is laid down directly from the spinnerets onto the rotating prey, the spider moves its abdominal apex, in an arc, from side to side along the length of the prey. The movement is probably the functional equivalent of the movement of the line distributor on a fisherman's spinning reel. The strands of the silk swathe are still widely separated

where they are rolled onto the prey. This spreading effect may be a consequence of the fact that the spinnerets on the moving abdomen describe a side-to-side arc and not a straight line. Figure 4 illustrates this point.

Very long prey (phasmids, for instance) or very long prey with bulky wings (dragonflies) may have only part of their length subjected to the throwing phase and be completely enswathed during the later stages of wrapping. In these cases the spider may itself move around and around the prey instead of remaining in one location and moving the prey around. It is interesting to note that when dragonflies are wrapped, the long abdomen may be doubled back along its own length, and the bulk of the resultant package considerably reduced as a conse-

quence. At first we thought that this might be a consequence of the prey curling its abdomen in some type of defensive response to the spider's attack, but

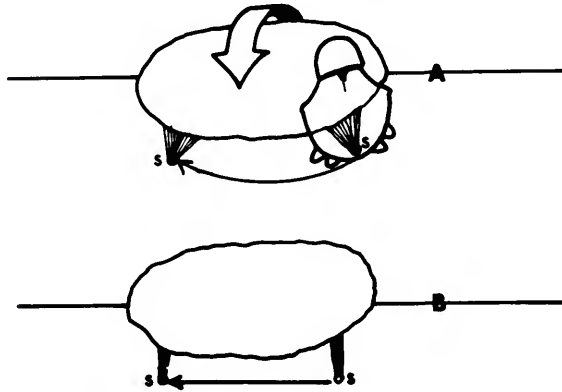

FIGURE 4.—Diagram showing rotation of prey package in relation to the spider and the effects of the movement of the spinnerets S, along an arc (A) rather than a straight line (B). The spider's legs are omitted from A.

the effect is also seen after wrapping attacks on dead dragonflies and must, therefore, be a result of the wrapping process. In a similar manner the wings and legs of other insects are often subjected to a trussing effect. Lepidopterans often strike the web with their wings in extended flight positions (Figure 5), but after wrapping, these are often reduced to much less bulky prey packages in which the wings are laterally, or dorsally, closed and bound together. The wrapping silk seems to have a trussing or binding effect because it is laid down under tension and may possibly contract in situ. It is certainly quite elastic when produced and also seems to be adhesive.

Wrapping also occurs during transportation and at the hub. In both cases the wrapping is initiated while the prey is held in the jaws, and on some occasions this also happens following a biting attack on prey. As the prey is held in the jaws the legs IV pass silk forward onto it, and after a few skeins of silk are applied, the prey is then passed back to legs III, which hold it until wrapping is completed. The process is short

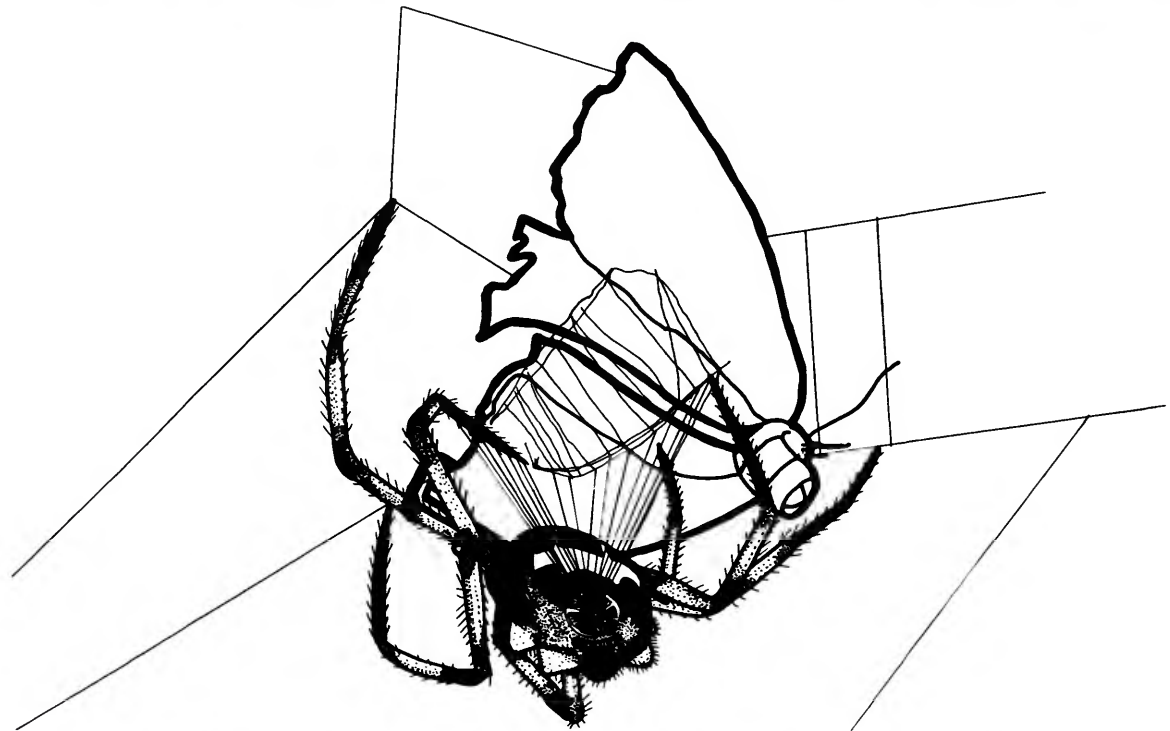

FIGURE 5.—*Argiope argentata* wrapping a moth. Note that the silk is being cast onto the insect's surface by the movements of the fourth legs. The moth has previously been immobilized by biting. (From a frame of 16 mm movie film.)



FIGURE 6.—*Argiope argentata* biting a butterfly at the wing bases. Note the damage to the web and the grasping positions of the legs. (From a 16 mm movie film.)

in duration—prey that are wrapped during transportation or at the hub have either been wrapped at the capture site or are very small and are only wrapped at the hub. Wrapping at the hub after transportation is always effected before the spider assumes a head-down position. The spider does not often carry prey to the hub if there is previously caught prey already there. If the previously caught prey at the hub is small or nearly digested, however, the spider may carry a newly caught prey and wrap the two prey into one parcel on arrival. The spider may also rewrap prey at the hub after a period of feeding.

Spiders with one leg IV missing are still capable of wrapping and eventually produce a “normal”

prey package. There is, however, a very considerable increase in the time spent over the throwing stage of the wrapping process.

Robinson (1969) noted that during the final stages of wrapping behavior, at the capture site, the pedipalps are brought into close contact with the silken envelope surrounding the prey. He suggested that these sense organs may then be monitoring the completeness of the covering silk and providing information which could affect the “decision” to stop wrapping. We have seen this movement of the pedipalps to a position of contact with the covering silk on many occasions and regard it as a regular feature of wrapping behavior.

BITING

The bite is given as a first response to lepidopterans, and after immobilization wrapping in the case of most other insects. In a biting attack the spider seizes the prey with its legs and more or less simultaneously buries the chelicerae in the prey. The bite is often delivered to the first point of contact with the prey. Sometimes this happens to be a wing or other appendage, and the bite is then transferred in short steps until it penetrates a more substantial part of the prey. It is possible that such changes in bite location result from sensory information received directly by the chelicerae. Figure 6 shows *A. argentata* biting a butterfly.

When the prey is bitten after wrapping, the bite is often directed at the head or thorax, and a sustained bite may be preceded by a number of short (momentary) bites delivered along the surface. Insects which have a particularly thick cuticle (e.g., beetles) are often subjected to a large number of short (perhaps exploratory) bites, and the final (sustained) bite frequently occurs at the site of an intersegmental membrane.

Spiders presented with nonedible artifacts often bite these before rejecting them. If the artifacts are motionless the bite occurs after preliminary touching, whereas if they are vibrating, the spider wraps them as a first response and then bites them. We were able to score the number of cheliceral penetrations of such artifacts by counting the number of punctures on the previously virgin surface. These scores bear out the direct observation that multiple biting precedes rejection. In addition, examination of the artifacts revealed a discoloration around the puncture sites. We regard this as evidence of an active secretory process during biting. In these circumstances biting may constitute an investigation of the edibility of objects in the web. The use of multiple bites would clearly be adaptive since the first bite at an insect might not provide adequate sampling of its edibility.

CUTTING OUT

When the attack couplets bite/wrap and wrap/bite are completed, the spider eventually removes the prey from the web at the capture site. This process is frequently accomplished by the spider's cutting the web members that are still in contact with the prey.

The number of threads to be cut depends on the extent of the initial entanglement and also on the effects of the wrapping process on the entangling threads. The spider may have cut or broken web threads during the rolling process and the prey may thus be largely free of the web. Figure 7 shows the extent of intact web impinging on a cricket after it had been wrapped by *A. argentata*. When the prey is attached by the axial threads (see the description of wrapping) and a few residual elements of the viscid spiral, the spider cuts the attachments with its jaws. It may, however, simply cut the axial threads with its jaws and break the other threads with its feet. We do not know of any process by which the tarsal claws are capable of cutting silk, but some threads are certainly dealt with by the feet rather than the jaws.

The order of cutting the axial threads varies according to whether the spider is to carry the prey in its jaws or suspended from a silk line. This suggests that the "decision" on the carrying technique to be employed is made before the cutting out process is commenced. Prey carried in the jaws are cut out at the hub side first and the spider then turns through 180°, holding the prey with various combinations of legs I, II, and III, as it turns to face the hub. As it faces the hub, it then cuts the point or points of attachment that remain. The prey is then seized in the jaws and the spider walks toward the hub. If the prey is to be carried behind the spider, suspended on silk, the order of cutting is reversed. The spider cuts the points of attachment away from the hub first, and as the web contracts, the prey is left suspended, from the hub side, in a hole in the web. At this stage the spider usually casts a few swathes of silk over the prey and then cuts the hub-side attachments as it walks forward, dragging the prey behind it.

On occasion the spider may commence carrying the prey after cutting the major attachments but ignoring a number of minor attachments. In these circumstances it may proceed hubward with a partially freed prey and tear a large hole in the web as it proceeds. In other cases the spider stops transportation and cuts the restraining lines with its jaws or feet. The process of blundering forward with a partially attached prey seems to occur most frequently if the prey is being carried on a line behind the spider, and, conversely, it is more likely to stop carrying and free a partially attached prey, if this is being carried in the jaws. It seems possible that the

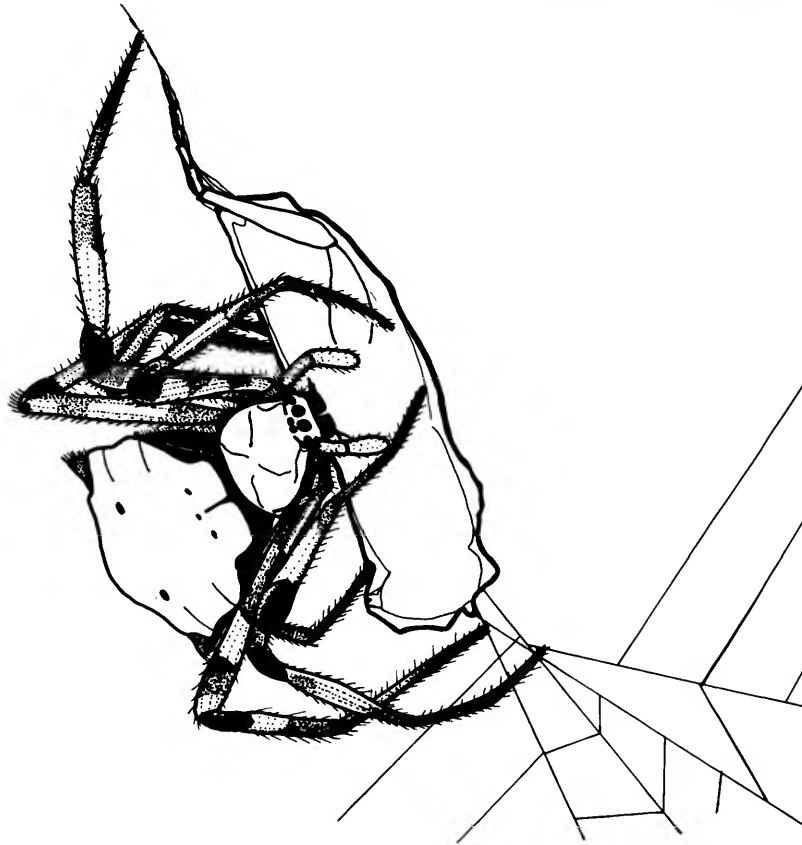

FIGURE 7.—*Argiope argentata* biting a wrapped cricket. Note the extensive damage to the web that has resulted largely from the wrapping attack and the axial threads which formed the axis of rotation of the prey package. (From a 16 mm film.)

resistance exerted by residual attachments is detected most rapidly (and readily) in the case of prey carried in the jaws. When prey is carried on a silk line, this may stretch, or more thread may be pulled from the spinnerets as resistance is exerted on the forward movement of the prey package, and these effects could confuse the spider.

When the jaws are used for cutting, the spider either moves them down to the silk to be cut or grasps the silk line with a foot and raises it up to the jaws.

PULLING OUT

As noted in earlier descriptions, very small or very light prey are pulled out of the web after being seized in the jaws. The pulling out movement does

not involve any cutting and may be achieved without damage to the web. Pulling out is accomplished by the spider extending its legs from the flexed position, which enabled the spider to seize the prey in the jaws. The spider thus pushes down on the surrounding web structure and pulls up on the prey. Removal of prey is accomplished in one or two such movements. The technique is used by *Nephila clavipes* for a large number of prey items, including such prey as adult crickets, which *A. argentata* always cuts from the web. *Argiope aurantia* Lucas often pulls lepidopterans out of the web without wrapping them, but this behavior is not consistently evoked by such prey. Lepidopterans do not adhere very strongly to the web of *A. argentata*, and it seems quite possible that one factor preventing the spider from using the pull-

out technique for butterflies and moths is the fact that it has comparatively short legs. Thus the maximum possible body-to-web distance may be insufficient to allow bulky prey to be freed by pulling. We regard this as a factor which may have influenced the course of evolution of the *A. argentata* predatory behavior.

TRANSPORTATION

CARRY IN JAWS. A wide variety of prey are carried to the hub in the jaws. This is, at least in part, a response to prey below a certain range of weights in relation to the spider's weight (Robinson, 1969). During such transportation the prey may lie beneath and parallel to the spider's body, but it is usually held in front of the spider and projects either laterally or dorsally. In these circumstances the free end of the prey package may be supported by one of the first legs, which is thus not used in the locomotory process. Spiders carrying large prey in the jaws almost always move back to the hub by walking along the web surface and not by moving along their drag line below the web surface.

CARRY ON SILK. When prey are carried back to the hub, suspended on a silk line, they hang behind the spider and away from the web surface. We have never seen prey carried from the upper part of the web in this manner. The carrying line is not detached from the spinnerets, and in some cases the prey package is carried directly hanging from these organs. In other cases the silk transport line is held by the tarsus of one of the fourth legs. The prey is always carried at least one spider's length away from the spider. We have never seen prey being carried directly from the tarsus of a fourth leg (i.e., with the tarsus grasping the silk covering of the prey package). This behavior does occur in other araneid species.

Spiders carrying prey on silk may return to the hub by walking up the web surface or by ascending their drag line. The latter process is usually very rapid and the manner in which it is achieved needs careful analysis. When the web surface is not strongly inclined to the perpendicular, the spider may ascend the drag line, while simultaneously fending itself away from the web surface by sporadic thrusts of one or both fourth legs.

The ability to carry a prey package hanging directly from the spinnerets is of considerable interest.

McCook (1889, p. 253, fig. 233) noted that prey packages could be carried by the spinnerets alone. There is apparently no discernible structure, however, in the silk gland/spinneret complex that could enable the spider to clamp, or restrain, the silk. The situation is thus somewhat anomalous. Wilson (1969), however, has noted that spiders dropping on their drag lines can remain suspended without holding onto the line with the fourth leg. They are thus able to support their own weight directly from the spinnerets in some as yet unexplained manner. The observations on prey transportation directly from the spinnerets, together with the ability of the spider to hang on the drag line, suggest that a search for a "brake" mechanism in the silk gland/spinneret complex should be fruitful.

ATTACHMENT OF PREY TO THE HUB

The spider attaches the prey to the hub, on arrival. If the prey is carried on silk, the carrying line is simply pushed against the hub silk and attached. After this the spider turns to assume a head-down position. During the turning process the spinnerets may be dabbed against the hub silk, in an arc, and the line attached to the prey may thus be attached at several points. A similar movement was observed by Peters (1931) in the case of *Araneus diadematus*. He called it the *Rundgang*. If the spider arrives at the hub with prey in the jaws, it is briefly wrapped, then transferred to the suspended position, and treated in the same way as prey carried on silk. Very small prey may not be wrapped until the spider has assumed a head-down position.

PREFEEDING FOOD MANIPULATION

After the spider has attached the prey to the hub and assumed a head-down position, it eventually starts the process that Robinson (1969) called manipulation. This consists of turning the prey package around and delivering short bites at various regions of the prey package. Legs III are the principal appendages involved in the turning process. The period of manipulation varies considerably, even with prey of the same weight and type. It is terminated when the spider assumes a cruciform attitude (Figure 1). Very frequently the final site for cheliceral insertion is on the anterior part of the prey package. The func-

tion of this choice of initial feeding site is not clear. Robinson (1969) suggested that it might provide the most direct access to the rich protein sources comprised by the muscles of locomotion and flight. After manipulation, the prey is usually held with the greater part of its length below the spider (Figure 1).

REST STAGES AND GROOMING ACTIVITIES

In some cases after the spider has attached the prey to the hub, it assumes a crudely cruciform position and for some time does not pick up the prey and begin manipulation. In our diagrams of behavior sequences this stage is figured as "rest" and may follow "carry," or "wrap at hub." During this period the spider carries out grooming activities and these vary in duration according to the type of prey that the spider has captured. They are most conspicuous after encounters with butterflies and moths and also occur at high intensity, in many cases, after the spider has captured pentatomids. Several activities comprise grooming. Usually the tarsal region of all the legs receives great attention. Frequently, the tarsi are brought to the chelicerae and drawn between these organs in a pulling movement. We do not know whether the tarsi are drawn between the apposed inner margins of the first segment of the chelicerae or whether they are moved between the fangs and the apex of the first segment. Both regions of the first segment (the inner face and the base) are amply provided with bristles or stiff hairs. In addition to this type of grooming, the legs may be scrubbed against each other, in pairs, and the pedipalps and chelicerae rubbed against each other. If the prey is a lepidopteran a small cloud of detached wing scales may result from each step in grooming. The particular attention given to the tarsi may be related to the presence of chemosensory organs on these structures. We have not seen *A. argentata* groom the surface of the body, although movements of the leg bases during tarsal grooming, and also the movements of the pedipalps, may serve to groom the eye region.

Grooming activities may also be carried out when the spider pauses during an attack—at the "rest on prey" stage—and also when it returns to the hub after leaving the prey at the capture site following a wrap/bite attack.

DEFECATION

Defecation is not part of the predatory sequence but often occurs after the commencement of feeding and even during biting at the capture site. The movements involved are conspicuous and appear to function to prevent fouling of the web by excretory products. As far as we know, these movements have not been described previously. The spider extends legs III and IV, and flexes legs I and II, thereby increasing the distance between the abdominal apex and the web surface. In addition it swings the abdomen dorsally so that it forms an angle with the cephalothorax. The subterminal anus is thus directed away from the web surface and the excretory products are then discharged under pressure and squirt away from the web. The walls and doors of our spider cages eventually register the defecations of the spiders as groups of whitish deposits arranged in clusters. In this way it is possible to count the numbers of defecations per day, on different food regimes, and it should also be quite easy to collect the material for calorimetric studies. The occurrence of defecation during attack biting is suggestive of fluid uptake at this stage.

DRINKING

We find that spiders will drink from droplets of water on the surface of the web even under conditions of high humidity and plentiful food supply.

Description and Analysis of Behavior Sequences

GENERAL

The following descriptions of behavior sequences are presented in an approximately standardized form. The responses given to each type of prey are outlined separately and illustrated in a standard form. The descriptions include an analysis of the variations in behavior that occur to a common type of prey and, under a separate heading, an analysis of the most important aspects of the temporal variations within a sequence. We have made comparisons between the sequences given to the different types of prey under a separate heading but have also noted major comparative differences under the descriptive headings. This process minimizes repetition.

All the diagrams that we use to illustrate behavior sequences show the basic units of behavior connected by arrow-headed lines. The arrows indicate the direction of change from one behavior to another, and the width of the lines is proportional to the percentage of responses that occur in the direction shown. In some cases the lines are shaded so that it is possible to follow sequences that were initiated by different behavior units. To avoid undue complexity we have omitted preattack behavior units from the diagrams.

BEHAVIOR SEQUENCES WITH LIVE DOMESTIC CRICKETS AS PREY

Figure 8 shows, in graphic form, the responses of the spider to 100 live domestic crickets that were presented in the lower part of the web (anywhere below the hub). From this figure it is possible to follow some of the main features of the most commonly occurring behavior sequences and the variations that occur between sequences. The diagram is a summary of trends and does not allow individual sequences to be followed.

Note that the "wrap first" response is given to all the crickets and that the preponderant behavior sequence given for crickets is: wrap, bite, rest on hub, cut out, carry, manipulate, and feed. This seemed to be a clear-cut sequence, following a small number of initial observations carried out at the preliminary stage of our investigation. As we made more detailed observations on a large number of sequences, however, it became obvious that, although this was a basic sequence, it was subject to variation at a number of points. The first one of these was the occurrence of a second wrapping stage after the bite. The bite follows the wrap in 92 percent of all sequences, but in 28 percent of the cases the bite is followed by a second wrapping stage. These variations are of considerable interest in the analysis of spider behavior. If we are to assume, as Peters (1931) did for the behavior of *Araneus diadematus*, that some stimulus which the spider receives from the wrapped prey triggers the bite response (and that a stimulus from the bite triggers removal from the web and carrying), then sequence variations are of great importance. Similarly if the wrap response is turned off as a result of the spider monitoring the surface of the

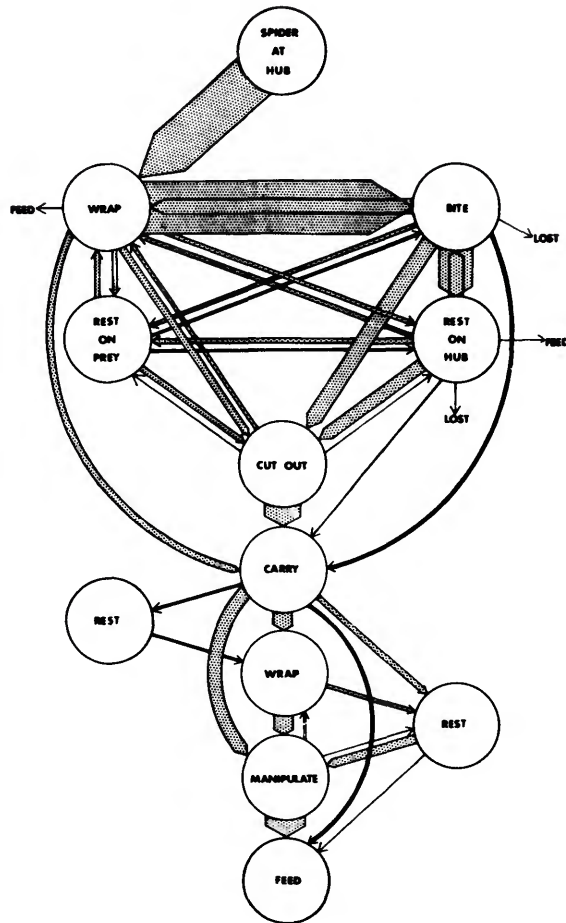

FIGURE 8.—Behavior sequences in the treatment of live domestic crickets. (For explanation of this and similar diagrams see text.)

wrapped prey during wrapping (see above and Robinson 1969), we have to explain the stimuli which cause the spider to wrap a second time after the bite. A second wrapping response also occurs after the behavior rest on prey in 6 percent of the sequences. A second wrap response also occurs after the rest on hub stage and is here strongly associated with the subsequent behavior of carrying the prey on a silk line. Sixty-eight percent of the crickets, however, were carried in this way and not all of them were wrapped after the cutout stage. The spider simply attaches a silk line to the prey package and carries without rewrapping.

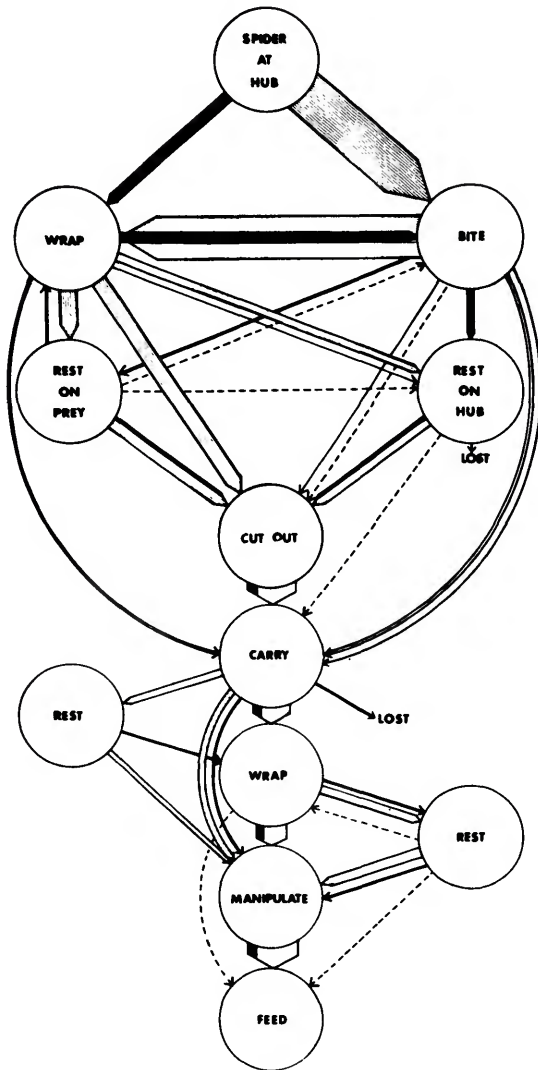

FIGURE 9.—Behavior sequences given to live moths. Sequences initiated by wrapping are shown in black or solid lines.

It is interesting that a number of the spiders go from the wrap stage to the carry stage without cutting the prey from the web (14 percent), and a smaller proportion go from bite to carry without a cutout stage (6 percent). The process of wrapping may in some cases almost completely free the prey from the web, and the spider can carry without the necessity of cutting the prey free. This fact may account for the omission of the cutout phase in the cases reported above.

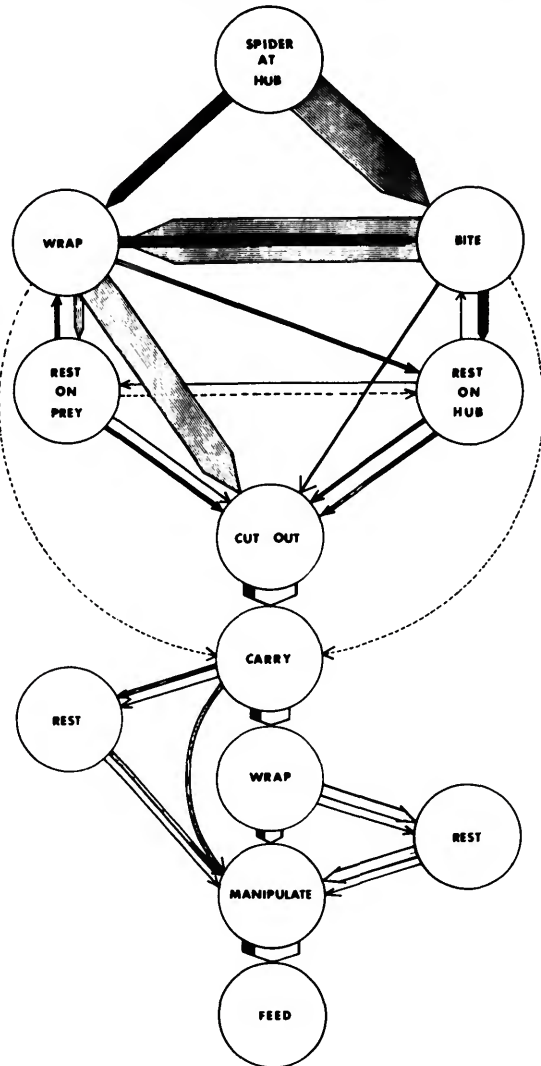

FIGURE 10.—Behavior sequences given to dead moths.

The phase rest on hub occurs in 87 percent of the predatory sequences given to crickets. This response differs markedly from that given to moths, where only a small number of spiders rest on hub (Figures 9 and 10). The spiders also rested on prey at a fairly low frequency (33 percent). This response is much more frequent in sequences given to other types of prey, particularly pentatomids (Figure 11).

Later stages of the prey-capture sequences also show some variation. The most striking of these is

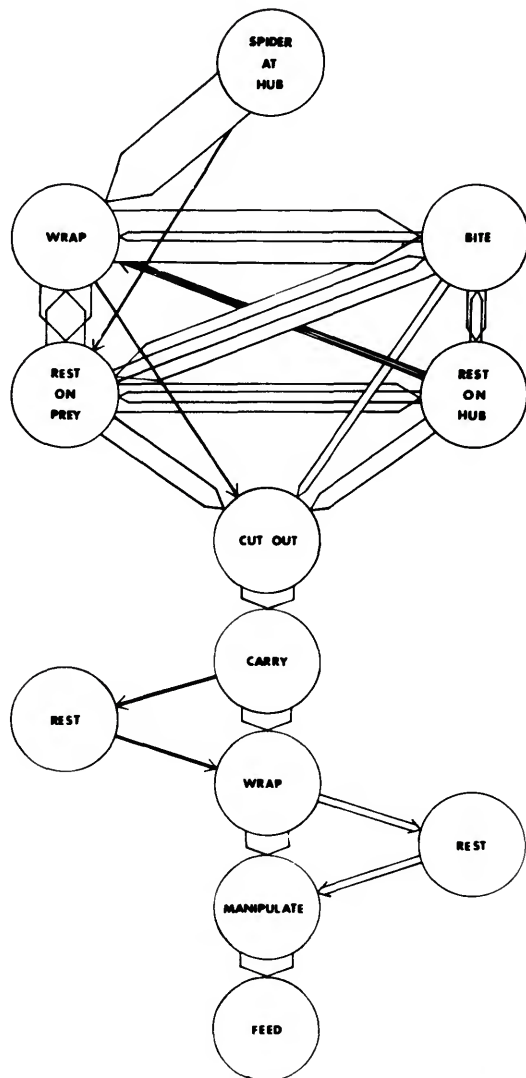

FIGURE 11.—Behavior sequences given to live pentatomids.

the absence of a wrap at hub stage in 62 percent of the sequences. The greater proportion of these were sequences in which the prey were carried behind the spider on a silk thread. Nearly all crickets carried in this way are simply hung from the hub when the spider reaches that region. Only 11 percent of the crickets that were carried to the hub on silk were wrapped before the commencement of feeding, whereas 91 percent of the crickets that were carried in the jaws to the hub were rewrapped at this stage.

An additional 8 percent of these were wrapped after the spiders started prey manipulation.

A small number of spiders assumed a resting position at the hub before the beginning of wrap at hub or prey manipulation.

TEMPORAL ASPECTS OF THE SEQUENCES. In addition to recording data on the relationships between the units within the behavior sequences, we also recorded the time spans occupied by these units. Much of this information is mainly of interest from the comparative standpoint and is discussed and tabulated later. There are, however, some interesting variations in the time spans of behavior units given to the same type of prey. Thus the range of wrap times given to crickets was from 3 to 88 seconds and the range of bite times 1 to 126 seconds. These variations were not systematically correlated with the weight or length of the prey, nor were they referable to variations in the state of hunger of the spider as far as we manipulated this during the observations. (We usually did our cricket presentations on a six-day schedule, each spider receiving six crickets on successive days, with two foodless days before the next series of six presentations. Thus on the first day of the second series the state of hunger should have been greater than on any day after the first day of a series.) We have at present no explanation to offer for the variation in the duration of the attack units, which may be due to the operation of multiple variables that our technique cannot detect. The rest-on-hub behavior is equally variable in duration, and attempts to correlate variations with the length of the preceding attack phase (when rest at hub might constitute a period of recuperation from subduing the prey) have failed to reveal any systematic trends. There is also no correlation between the duration of this phase and state of hunger.

CRICKETS PRESENTED IN THE UPPER PART OF THE WEB. We observed twenty-five behavior sequences that occurred after crickets had been presented in the upper, and smaller, part of the web. These were essentially similar to those that occurred when crickets were presented in the lower half of the web, up to the stage of prey transportation. At the stage of prey transportation there was a marked difference. Crickets of a weight that were carried on a silk thread in the lower web were not carried in this way in the upper half. All except five of these crickets were carried in the jaws. The five that were not carried

in the jaws were dealt with by a complex behavior sequence that we call the "derrick technique." All the prey thus treated were over .5 grams in weight. The spider, after immobilizing the prey by wrapping and biting, took a series (up to six) of silk lines from the prey package to the upper bridge thread of the web frame, thereby securing the prey to the web frame above it. The spider then returned to the prey and cut out the web members below it. The prey dropped and/or was pulled toward the hub, suspended on the lines from the bridge thread. If the prey dropped below or to the left or right of the hub, the spider approached it across the web and hauled it to a feeding position. Since this behavior was employed by five individuals, we feel that it may be part of the behavioral repertoire of the species. Our verbatim notes on one such incident read (after wrap, bite, rest on hub . . .) as follows:

Spider approaches prey, brief wrap, climbs up web holding out drag line with right leg IV, attaches to bridge thread, down to prey, attaches drag line and goes back to bridge thread. Returns to prey and cuts below. Prey falls to left of hub and stops about 1" above hub region, hanging free of the web. Spider returns to hub attaches drag line and then returns to prey, attaches drag line to prey and moves back to hub swinging the suspended prey in toward the hub. Prey now level with the hub and about 2" to left. Second approach to prey, repeat process of attaching drag line and swinging prey inwards. This time prey reaches hub and spider attaches line from prey to hub silk. Spider rests and cleans tarsi. Short wrap at hub, attach again and then manipulate, small bites and feed.

We saw an even more complicated form of this behavior when the spider actually fell out of the web, clinging to a large cricket. In this case the spider "derricked" the prey from the cage floor to the rear wall of the cage and then carried it on silk to the intersection of the cage wall and the upper part of the web. Once it was in this position the spider moved the prey down to the hub on a series of derrick lines. This was a very remarkable performance and took nearly 16 minutes to accomplish.

Wrapping at the hub occurred in all but one of the twenty-five sequences. This is of interest since Robinson (1969) suggested that one function of wrapping at the hub might be to safeguard the spider against losing the prey as it turns to face head down. But when the spider returns from above the hub, it may not need this safeguard since it does not have to turn at the hub. The wrap at hub stage still occurs, however, and it seems probable that it serves the

function of securing the prey to the hub and is not associated with the turning process.

BEHAVIOR SEQUENCES WITH LIVE MOTHS AS PREY

Figure 9 summarizes the responses given to 134 live moths. These, as mentioned earlier, were of several different species and genera. This factor may be a source of uncontrolled variability in the behavior sequences. The results are, in fact, no more variable than those obtained in the cases where we used a single species of insect throughout the observations, and we feel that the use of several species is not a major source of error. (We carefully excluded species that are known to possess chemical defenses that may affect the spider's behavior.)

The initial response to moths differed fundamentally from that given to live crickets. The greater proportion of moths were bitten as a first restraint (82.8 percent) and then wrapped. Only 17.2 percent were wrapped and then bitten (the attack couplet that live crickets elicited). We regard these cases as being due to discrimination failures (Robinson, 1969). This view is supported by the fact that other araneids discriminate between moths and other insects and their failure rates differ from those of *A. argentata*. Thus *Argiope savignyi* Levi, which may include a greater proportion of Lepidoptera in its natural diet, attack wraps only 8 percent of live moths. The nocturnal araneid *Eriophora fuliginea* (C. L. Koch), which may be a moth "specialist," judging by the typical structure and location of its web, makes less than 6 percent mistakes with live moths. Both these species have an apparently more perfect discriminatory ability with respect to live moths than has *A. argentata*.

Nearly 9 percent of the moths that were attacked by biting were not subjected to wrapping at the capture site but were pulled out of the web and carried in the jaws to the hub. This is a very interesting behavior that is part of the response of the spider to very light prey and some flies. Its evolutionary significance is discussed later.

The moths that were subjected to the wrap/bite attack couplet were subsequently subjected to sequences of behavior that were essentially similar to the preponderant sequences given to domestic crickets. This can be seen by following the solid black

lines on Figure 9 and comparing them with the preponderant sequences shown in Figure 8.

The moths that were bitten first were then subjected to behavior sequences that differed in at least one important respect from those that followed wrapping attacks. This was the preponderant suppression of the rest at hub phase. Over 75 percent of the moths attacked by biting were transported to the hub after the completion of the attack phase and without an intervening rest on hub stage. Variations in the occurrence of wrapping at the hub are largely correlated with the method of transportation, as in the cricket sequences. The occurrences of rest stages before wrapping at the hub, or before prey manipulation, are as variable as in the case of crickets as prey.

TEMPORAL ASPECTS OF THE SEQUENCES. As in the case of the behavior sequences elicited by domestic crickets, there are complex variations in the duration of the bite and wrap phases of behavior. Bite times (where bite was the initial behavior) ranged from 1 to 527 seconds and wrap times from 0 to 485 seconds. Temporal variations in the other behavior elements were equally striking. There was a marked difference in the bite times between moths that were bitten first and moths that were wrapped first, the first bites being significantly longer in duration. There was also a difference in wrapping durations. The duration of wrapping, as a first means of attack, was longer than the duration of wrapping after a biting attack. These results are given in detail (with statistical analysis) in Table 3.

BEHAVIOR SEQUENCES WITH DEAD MOTHS AS PREY

Since the response to live moths involved a preponderance of bite/wrap attack couplets, and Peters (1931) reported that this means of attack was evoked by prey vibrations in the case of *Araneus diadematus*, we carried out 50 observations on the responses of *A. argentata* to dead (nonvibrating) moths. The results are shown in Figure 10. Slightly more moths elicited the wrap/bite attack couplet, but the difference is not significant. The spiders pulled out, without wrapping, 4 percent fewer of the dead moths after biting than was the case with the live moths. Otherwise the sequences given to dead moths roughly approximate to those given to live moths. There is a difference in the number of rest on hub

responses given after biting attacks on dead moths as compared with the occurrence of this stage after biting attacks on living moths (compare Figures 9 and 10).

TEMPORAL ASPECTS OF THE BEHAVIOR SEQUENCES. There is a difference between the duration of bites given to dead and living moths as a first response, that given to living moths being, on average, slightly longer. This difference is not significant. The duration of wrapping after biting also differs when the moths are dead; in this case it is longer, but not significantly so, than in the case of live moths.

BEHAVIOR SEQUENCES WITH LIVE PENTATOMIDS AS PREY

Live crickets usually kick persistently when enmeshed in spider's webs and live moths flutter vigorously. Pentatomids merely move their relatively short legs in an apparently feeble manner. They do, however, have a strongly repugnant odor. We thought that these differences in activity and chemical defenses might affect the spider's approach to pentatomids and be reflected in the behavior sequences. We therefore carried out observations on fifty complete sequences given to pentatomids. The results are summarized in Figure 11. Pentatomids, like crickets, elicited the wrap/bite attack couplet. In no case did the spider bite the pentatomid as a first restraint. We had no instance of a rejection response, despite the fact that the pentatomids produce a strong odor and repel the biting attacks of the spider *Nephila clavipes* (T. Eisner, personal communication). This agrees with the data on the natural prey of *A. argentata* (Robinson and Robinson, 1970), which show that pentatomids are a regular prey item throughout the year. Of all the prey with which we tested the responses of *A. argentata*, however, pentatomids elicited by far the greatest number of rest on prey responses (86 percent). These responses occurred not merely once in an attack sequence but several times. In 4 percent of the cases the spider hesitated for several minutes before initiating the attack. In addition, wrapping occurred at least twice in 48 percent of the sequences. We feel that these differences from the typical cricket sequence may be a result of the defensive secretion of the pentatomids. Certainly the spiders often made intensive grooming movements while resting on the prey. These were very similar to

those performed after attacking moths, but there were no superficial signs that the spider was removing prey-derived materials from its body surfaces.

TEMPORAL ASPECTS OF THE BEHAVIOR SEQUENCES. The outstanding temporal aspect of the predatory sequences given to pentatomids is the great duration of the rest on prey phase. This is, on average, greatly in excess of that occurring in the responses to any other prey type. The forty-three spiders that rested on prey did so for a mean period of 178 seconds (range 11 to 509 seconds). Bite and wrap times are compared with those given to other insects in Table 3.

BEHAVIOR SEQUENCES WITH LIVE DRAGONFLIES AS PREY

Dragonflies are the largest prey caught by *A. argentata* that make very rapid wing movements when enmeshed. This behavior could perhaps be expected to induce changes in the basic predatory sequence given to non-lepidopterans. We therefore recorded details of fifty behavior sequences given to these insects. Figure 12 summarizes the results. With dragonflies, for the first time in our study, we recorded a long bite attack response to a non-lepidopteran. This occurred on only one occasion and we therefore feel that it may be an aberrant response. In other respects the sequences that we recorded for dragonflies as prey are similar in the order of their components to those given to crickets. Rest-on-prey stages occurred in 44 percent of the sequences and rest on hub in a very high proportion of cases. Prey are carried, without prior cutting from the web, in the largest number of cases that we recorded for any type of prey. This is correlated with the fact that in the intensive wrapping process, because of the large linear dimensions of dragonflies along two axes almost at right angles to each other (wings and body), the web is destroyed over a relatively large area. As a consequence the prey is largely freed from the web during the wrapping process and can be torn from the remaining attachments immediately prior to the carry stage. The wrapping of dragonflies resulted in the abdomen being bent back along its length in 44 percent of the sequences. In almost all cases the initial throwing component of the wrapping attacks was directed at the head and thorax of the prey.

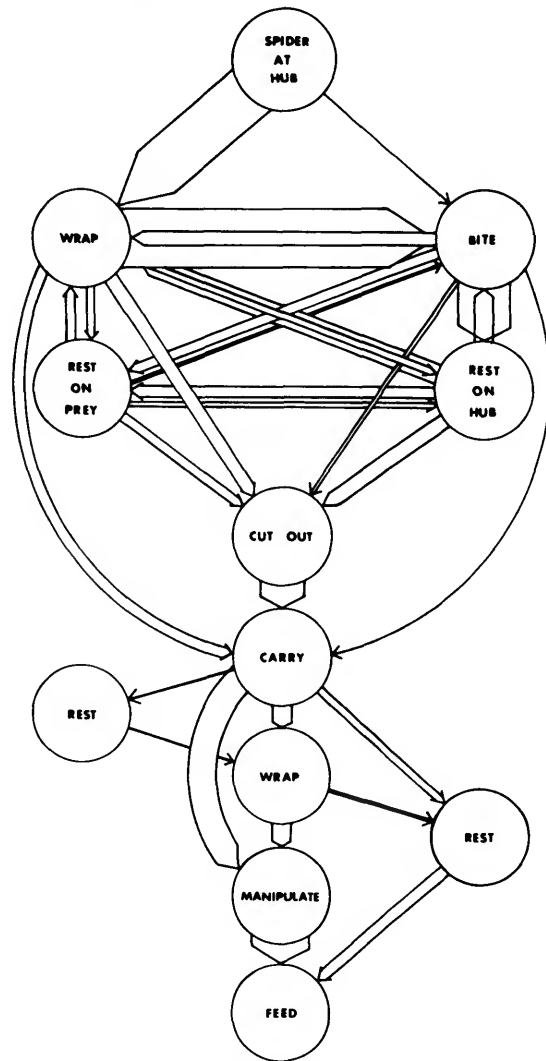

FIGURE 12.—Behavior sequences given to live dragonflies.

This process effectively secures the wing bases and restricts the further movements of the prey.

TEMPORAL ASPECTS OF THE BEHAVIOR SEQUENCES. It is interesting to note that the mean wrapping time that we recorded for dragonflies is higher than any that we recorded for other types of prey. This is true despite the fact that the average weight of these prey was less than the average weight of the live crickets. Thus the mean wrap time for dragonflies was 43.2 (range 3 to 146 seconds), whereas for crickets it was 26.6 (range 3 to 88 seconds). The time

spent in transporting the prey to the hub from the capture site is high and greatly increases the total duration of the predatory sequences. The prey packages produced from dragonflies are large and relatively cumbersome, and the spider seems to encounter considerable problems in transporting them. Our records show that dragonflies carried to the hub in the jaws are liable to catch in the web on the way to the hub. This happened to nine of the twenty-six dragonflies that were carried in the jaws. When this happened the spider stopped, rewrapped the prey, cut it from the web, and then carried it suspended on silk. This process added greatly to the time spent in transporting the prey. An additional six dragonflies became entangled in the web as they were being transported, on silk, to the hub. These were rewrapped and cut from the web before transportation was resumed. Eight of the dragonflies that were successfully carried all the way to the hub in the jaws were dragged up the web as the spider held onto a wing tip. In four cases the spider moved prey to the hub by a modification of the derrick technique. These unusual transport techniques, and the difficulties that ensued when the spiders used normal techniques, added greatly to the total sequence times (Table 3).

BEHAVIOR SEQUENCES WITH LIVE *Trigona* SP. AS PREY

Stingless bees of the genus *Trigona* constitute the most numerous prey item of *A. argentata* in the laboratory clearing of Barro Colorado Island (Robinson and Robinson, 1970). It therefore seemed appropriate to observe the behavior sequences that these small (about .015 gm) prey elicited. The results are summarized in Figure 13. Two percent of the *Trigona* were bitten and pulled from the web without being wrapped at the capture site. This is a response that is normally given to very light prey (Robinson, 1969), and we assume that the individuals that were treated this way were well under the average weight of the worker bees. In these experiments we did not weigh individual bees but weighed them in tens and then worked out the mean weight. We therefore cannot be certain that the individuals that were seized and pulled from the web were of low weight but feel that this is most probable. The araneid *Eriophora fuliginea* which is almost twice as heavy as *A. argentata* (comparing mature individuals), bites and pulls out the greater proportion of *Trigona* presented to it

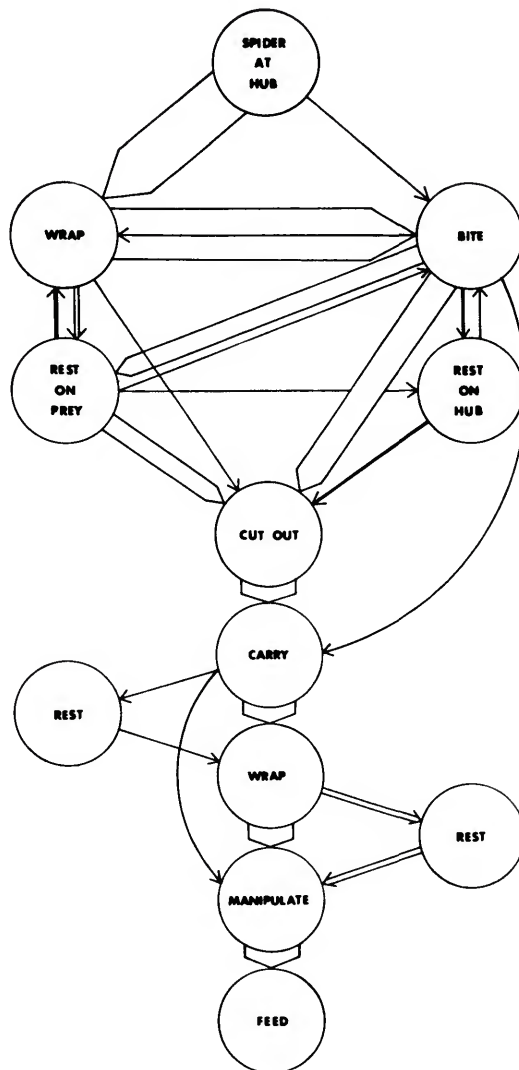

FIGURE 13.—Behavior sequences given to live *Trigona* sp.

(Robinson, Robinson, and Graney, in preparation). The responses to *Trigona* were all very simple when compared to those given to larger insects. Thus only 4 percent of the prey were subjected to a second bite and only 8 percent of the spiders returned to the hub for a rest on hub stage after the attack couplet. Ninety-eight percent of the *Trigona* were wrapped at the hub, on arrival, and this reflects the fact that all the prey were carried there in the spider's jaws.

The rarity of the occurrence of rest on hub when dealing with small prey is discussed in detail later.

It is consistent with the conclusion (Robinson, 1969, Robinson, Mirick, and Turner, 1969) that the short bite following attack wrapping could involve a small venom dose, and that retiring to the hub after the bite may enable the spider to continue monitoring the web while waiting for the bite to take effect. With small prey (less than 1/40 the spider's weight, in this case) the bite could be expected to operate quickly, and it would be inefficient, bioenergetically, to retire to the hub for a short time before beginning the process of cutting out and carrying the prey. When a rapid succession of prey strikes the web, however, the spider wraps, bites, then leaves the immobilized *Trigona* in situ, and returns to the hub (Robinson, Mirick, and Turner, 1969).

TEMPORAL ASPECTS OF THE SEQUENCES. The total sequence time for responses to *Trigona* is relatively short (mean = 77 seconds). The bite-and-wrap times are proportionally of short duration. A considerable speedup is achieved when large numbers of prey arrive in rapid succession and the cutout and carry stages are omitted. In these circumstances the mean time spent away from the hub may be as low as 18.6 seconds (data from Robinson, Mirick, and Turner).

BEHAVIOR SEQUENCES GIVEN TO LIVE FLIES

Argiope argentata, on Barro Colorado Island, catches very few dipterans, and large flies are a rare item in its natural diet (Robinson and Robinson, 1970). Most of the studies of araneid predatory behavior (see Peters 1931, 1933 for extensive references), however, have been largely concerned with the behavior of spiders toward flies. It therefore seemed appropriate to test the responses of *A. argentata* to flies. This proved to be a very difficult undertaking since we found muscid flies very difficult to obtain in any numbers. Attempts to obtain calliphorids at meat bait were frustrated by ants. We eventually resorted to collecting tabanids, with the senior author acting as bait. The results were somewhat equivocal and difficult to interpret. Dead flies were almost all wrapped, bitten, cut from the web, and carried in the jaws to the hub, where they were again wrapped. This result is essentially similar to the *Trigona* results; however, a small number of flies were pulled from the web after being seized in the jaws, and were then wrapped for the first time at

the hub. On the other hand, the live flies were subjected to three types of attack. The majority were treated in the same manner as the dead flies, but others were seized in the jaws and pulled from the web, while still others were bitten and then wrapped at the capture site. We considered that it was highly probable that flies striking the web from free flight (we released them from glass tubes held 6 inches away from the webs) might entangle themselves to varying degrees according to their (chance) orientation at the moment of impact with the web. Thus they might be capable of movements that would vary in intensity and frequency, dependent on the degree of enmeshment of the insect. Thus, if the spiders were responding to vibration, they might well be confronted with a wide range of vibration types. Clearly the only way to standardize the presentation of flies would be to vibrate dead flies held in contact with the web. At this stage we were fortunate to find a mammalian corpse that had a heavy infestation of calliphorid larvae. From this we were able to rear several hundred adult flies.

To check on our tabanid data, we first tested the behavior of the spiders toward live flies. The results are shown in Figure 14. Some of the flies were treated as before—by being seized and pulled from the web (24 percent). Others were wrapped and then bitten (74 percent), and a small proportion (2 percent) were bitten and then wrapped. The remainder of the behavior sequence was very simple indeed and can be followed from the diagram. We then tested the response to dead flies. Of these 80 percent were wrapped and then bitten, 16 percent were seized and pulled from the web, and 4 percent were bitten and then wrapped. When dead flies were vibrated at 250 cps, 32 percent were seized and pulled from the web, and the remainder were wrapped and then bitten. Rest on hub was virtually absent from the sequences given to the three types of flies (living, dead, and vibrated dead). These results raise the problem of why the flies elicit a substantial number of bite and pullout responses. This subject is discussed later.

TEMPORAL ASPECTS OF THE SEQUENCES. The sequences initiated by the seize and pullout attack technique were always shorter in mean duration than those initiated by the wrap/bite attack couplet but the difference is not significant. The sequence dura-

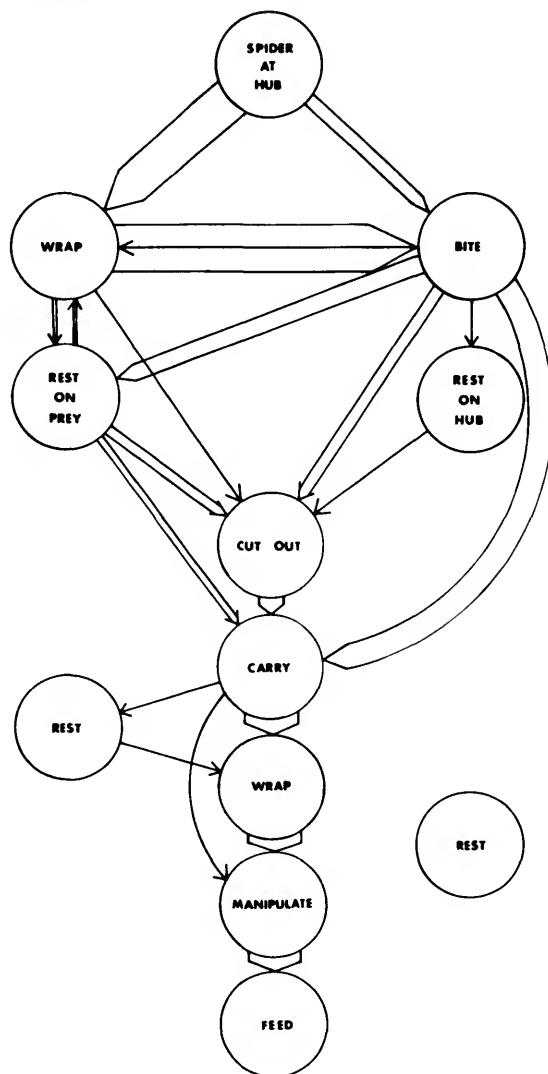

FIGURE 14.—Behavior sequences given to live flies.

tions, in general, closely approach those given to *Trigona* sp.

BEHAVIOR SEQUENCES ELICITED BY THE PRESENTATION OF ARTIFACTS

In order to investigate the effects of vibration on the spider's responses to prey, we decided to present vibrated and unvibrated models to them. Here it seemed possible to carefully control all extraneous

variables. We chose cigarette filter tips since they were of reasonable size and proportions, had a smooth surface, and were within a suitable weight range (80–85 mg). They were available in an uncontaminated form from the Rizla Company of England. We presented the tips to fifty spiders (twenty captive and thirty free-living) in alternating successive presentations of motionless and vibrating (250 cps). We found that the great majority of the tips were rejected before the transportation stage (96 percent). The rejection stage differed according to whether the tips were presented in a motionless or vibrated state. The unvibrated tips were treated to sequences involving tarsal contact, pedipalpal contact, multiple biting, cutting from the web, and rejection. Rejection involved the spider picking up the tip in legs I and II and then releasing it away from the web plane so that it dropped clear of the web. Forty-three tips were treated in this way, and twenty of these were bitten again after being freed from the web and before being dropped. Six of the unvibrated tips were wrapped after being touched and palpated, and two of these were cut out and transported to the hub. One spider manipulated and bit the prey package at the hub for over 5 minutes before rejecting it at that stage. Rejection thus occurred, in most cases, after multiple momentary biting and without wrapping. The number of bites could be scored by direct observation and also by examination of the rejected tip, which bore a number of bite marks on its smooth surface.

The great majority of the vibrated tips was subjected to wrapping (forty-two out of fifty) but only one was carried to the hub. The others were bitten after being wrapped and then cut from the web and rejected. Eight of the vibrated tips were not wrapped but subjected to touching, palpation, and multiple biting, and were then rejected. These results are of great interest since they suggest that some information received from the touch and palpate stages results in the suppression of wrapping behavior in the case of the unvibrated artifacts. This is noteworthy since dead unvibrated insects (other than lepidopterans) are invariably wrapped (Robinson, 1969). The fact that the greater proportion of vibrating artifacts was wrapped is of great interest. Although *A. argentata* can discriminate between vibrating moths and vibrating crickets (artificially vibrated at 250 cps), it apparently attacks vibrating lips as though

they were prey and does not discriminate until the bite stage following wrapping. If the discrimination of moths and butterflies from all other insects is based upon a difference in surface texture (Robinson 1969), then this may operate only if the difference from typical insect surface is gross enough to be detected quickly when the insect is vibrating. It must be highly adaptive to make a quick decision prior to attacking a vibrating prey, whereas a motionless object in the web can, perhaps, be investigated with less urgency. Insects that are already wrapped in spider silk and then presented to another spider are most frequently bitten and not wrapped, although they would be wrapped if they were not coated in spider silk. This discrimination holds even when the prewrapped prey are presented vibrating (Robinson 1969). The vibrating silk-wrapped prey must present the spider with a readily detectable cue to suppress wrapping behavior, whereas the vibrating tip does not.

We used further artifacts to determine whether a rough surface texture would suppress the wrapping response to a vibrating stimulus. Pieces of pipe cleaner were folded into masses approximately the size and weight of the filter tips and presented as vibrating stimuli (at 250 cps). Of twenty-five presented, eighteen were wrapped and seven bitten. This result is inconclusive and the whole matter is worthy of further investigation.

The use of the filter tips led to an interesting chance discovery. We noticed that a number of the tips that had been subjected to multiple biting were discolored around the bite marks and that this discoloration extended below the smooth surface layer into the absorbent inner layers. This suggests that the bite involves active secretion by the spider. This aspect of the predatory behavior of araneid spiders is poorly understood (McCrone, 1969). It seems possible that filter tips, or similar paper cylinders, could be used to monitor any secretion that occurs during biting, and that they might provide an uncontaminated source from which any such secretions could be extracted and analyzed. The bite that occurs after a wrapping attack on vibrated artifacts could, at least in the early stages, be a "normal" postimmobilization bite and might, therefore, contain the normal chemical constituents, if any, of such bites.

BEHAVIOR SEQUENCES GIVEN TO PLANT MATERIAL

We have observed a variety of plant material in the webs of *A. argentata* and decided to test the spider's responses to some types of vegetable matter. We chose to use sections of grass flowers and the flower heads of a commonly occurring entomophilous flower. The grass flower sections were smooth and cylindrical and taken from *Tripsacum* sp. Their weights ranged between .05-.08 gm, and their lengths between 20-35 mm. The flowers of *Melampodium* sp. (Compositae) were used on an entire capitulum cut from the stem immediately beneath the involucre of bracts. The capituli ranged in weight between .09-.120 gm. and were roughly hemispherical in shape.

Both types of plant material were presented by being dropped into the webs of spiders from a distance of 10 cm. We tested fifty individual spiders with each of the objects, using a new plant part for each presentation. Tests with the sections of grass flowers were carried out one week before the tests with the capituli of *Melampodium* sp.

Table 1 summarizes the results. In the case of the grass flowers, 4 percent of the spiders completed the entire predatory sequence and rejected the objects only after extensive manipulation at the hub. The greater proportion of grass flowers were rejected after exploratory biting (58 percent) and 12 percent were left in situ after a brief tarsal touch. Note that 6 percent of the grass flowers were wrapped and left in situ by spiders that were already feeding at the hub when the flowers were presented. This behavior, except for the absence of the short bite phase after the wrapping attack, is part of the normal predatory sequence.

TABLE 1.—*Response of Argiope argentata to plant materials*

Response	Grass flowers	Flower heads
Return to hub after touch.....	6	0
Reject after touch.....	2	2
Reject after touch/palpat.....	2	2
Reject after touch/palpat/bite.....	29	17
Reject after touch/palpat/wrap/bite.....	3	19
Touch/palpat/wrap/rest at hub.....	3	0
Touch/palpat/wrap/bite/rest at hub.....	0	3
Reject after touch/palpat/bite/wrap/bite....	3	2
Reject after normal prey-capture sequence....	2	5
Total.....	50	50

The other flowers evoked a higher level of complete sequences (10 percent) and a further 6 percent of sequences in which the spider retired to the hub after a wrap/bite attack couplet. Only 34 percent of the *Melampodium* sp. flowers were rejected after exploratory biting, and 38 percent were wrapped before biting and subsequent rejection.

The responses to plant materials were thus fairly complex and certainly more complex than the responses to unvibrated filter tips. The differences between the responses to the wind pollinated flowers and the insect pollinated flowers could, at least in part, be due to the perhaps more complex odor characteristics of the latter. It is even possible that the *Melampodium* sp. flowers had acquired odors from pollinating insects, or are confused with insects that have acquired their odor.

The occurrence of complete sequences of predatory behavior to basically inedible objects suggests that either some objects have sufficient relevant stimulus characteristics to pass a number of discrimination stages or that some spiders may not be sufficiently experienced in dealing with plant materials to enable them to make adequate discriminations. The further possibility that sensory input from the discrimination behavior may be insufficient to block a very strong predatory motivation cannot be discounted. This matter is discussed later.

Comparison of Behavior Sequences Elicited by Different Types of Prey

We have attempted to summarize the main differences and similarities between the behavior sequences given to various types of prey in Tables 2 and 3. Table 2 records the frequency of occurrence of all the observed behavior units in relation to each type of prey. We have included in this table some data that are not described in the preceding sections. Some of the data so used are taken from Robinson (1969), while others are incomplete data from our study. Incomplete data are those referring to the attack phase only and do not extend to the postattack phases of behavior sequences. They are included for the sake of comparison.

Table 3 summarizes our data on the durations of some of the behavior units elicited by different types of prey and includes means, ranges, standard errors, and standard deviations. This table also gives the

mean weights of the types of prey and their more important statistical parameters.

The differences in behavior that the tables reveal, and which have been partially expounded in the previous descriptive section, can be formalized in a review of the sequences that follow the three basic attack strategies. We present, next, such a review as an introduction to the discussion of the problems and generalizations that are engendered by our study.

SEQUENCES INITIATED BY THE WRAP/BITE ATTACK COUPLET

The following types of prey were attacked, either entirely or predominantly, by means of the wrap/bite couplet: crickets, grasshoppers, dragonflies, pentatomids, beetles, stingless bees (*Trigona* sp.), and flies. In all cases, except attacks on flies, this was the attack strategy employed in at least 98 percent of the sequences. Of these prey types only the *Trigona* and flies weighed less than .05 gms. It is therefore convenient to consider the treatment of the small, low-weight prey separately.

The prey-capture sequences given to large prey, with the single exception of the responses to pentatomids, included a rest at hub phase at a frequency of greater than 75 percent. This phase occurred after the completion of the attack behaviors and before the prey was transported to the hub. A rest-on-prey phase occurred during the sequences given to the larger prey, but occurred at a frequency greater than 45 percent only in the case of pentatomids. Pentatomids elicited a rest on prey stage in 86 percent of the sequences, and this behavior is similar in frequency to rest on hub for the other large prey. The repetition of wrapping and biting during the attack phase is generally of low frequency but was highest in the case of the pentatomids. Our incomplete data for attacks on beetles as prey suggest that the bite may be repeated several times in the case of these insects. This is also true for the behavior of *Eriophora fuliginea* toward beetles (Robinson, Robinson, and Graney, in preparation). Disruption of transportation by prey becoming entangled in the web, principally during transportation of the prey in the jaws, was highest in the case of dragonflies.

The prey-capture sequences that were elicited by the two types of small prey were striking in their relative simplicity. In the sequences elicited by flies and

TABLE 2.—Percentage of frequency of involvement of the various units of predatory behavior in sequences given to types of prey
(See text for explanation)

Prey and number observed	Attack couplet					At capture site		Post-attack behavior						Reference		
	Wrap+ Short bite	Long+ bite	Wrap	Bite and pull out	2nd wrap	2nd bite	Rest on prey	Rest at hub	Cut-out	Carry in jaws*	Carry on silk	Wrap at hub*	Rest at hub			
Crickets (L)..... N=100	100	92	No	No	No	28	34	33	87	80	Freq.	Freq.	38	32		
Crickets (D)..... N=50	100	90	No	No	No	Data on attack phase only										Unpublished
Crickets (V) ¹ N=30-42 Total 102	99	93.1	1	1	No	Data on attack phase only										Robinson, 1969
Grasshoppers (L)..... N=41	100	92.7	No	No	No	Some- times	Some- times	Freq.	Freq.	Freq.	Freq.	Freq.	Freq.	Some- times	Robinson, 1969, and unpub- lished data from small samples.	
Grasshoppers (D)..... N=20	100	90	No	No	No	Data on attack phase only										Robinson, 1969
Pentatomids (L)..... N=50	100	100	No	No	No	48	30	86	56	100	Freq.	Rare	100	25		
Pentatomids (D)..... N=20	100	100	No	No	No	Data on attack phase only										Robinson, 1969
Pentatomids (V)..... N=20	100	100	No	No	No	Data on attack phase only										Robinson, 1969
Beetles (L)..... N=32	100	100	No	No	No	Some- times	Freq.	Freq.	Freq.	Freq.	Freq.	Freq.	Freq.	Some- times	Robinson, 1969 and unpub- lished data from small samples	
Dragonflies (L)..... N=50	98	98	2	2	No	48	32	44	92	80	34 ²	66 ²	34	20		
Trigona (L)..... N=50	98	98	No	No	2	8	4	Some- times	8	98	100	No	98	14		
Trigona (D/V)..... N=30	100	100	No	No	No	Data on attack phase only										Robinson, 1969
Moths (L)..... N=134	17.2	17.2	82.8	74.8 ³	No	16	10	32	23	92	Freq.	Freq.	Freq.	35		
Moths (D)..... N=50	22	22	78	74 ³	No	11	8	18	17	92	66	34	66	39		
Moths (V) ¹ N=32-35 Total 103	19.4	19.4	80.6	80.6	No	Data on attack phase only										Robinson, 1969
Butterflies (L)..... N=25	16	16	84	84	No	Data on attack phase only										Unpublished
Butterflies (V)..... N=25	18	18	82	82	No	Data on attack phase only										Unpublished
Moth bodies (V)..... N=36	22.2	22.2	78.8	78.8	No	Data on attack phase only										Robinson, 1969
Flies (L)..... N=50	74	74	2	2	24	6	2	40	4	74	100	No	98	2		
Flies (D)..... N=50	80	80	4	4	16	4	No	24	No	Freq.	100	No	96	2		
Flies (V)..... N=50	68	68	No	No	32	No	No	No	No	Freq.	100	No	92	2		

* Prey carried in jaws is usually wrapped at the hub.

¹ Insects vibrated at three frequencies. Results averaged.

² Eighteen percent of dragonflies carried in jaws were tangled in the web on the way to the hub, wrapped, and carried on silk.

³ Small percentages of live and dead moths were pulled out of the web after the long bite and carried to the hub without being wrapped.

L = Live D = Dead V = Vibrated
N = Number of each type of prey observed

TABLE 3.—*Durations of behavior units occurring during attack sequences give to different types of prey*
(See text for explanation)

Prey and attack method	Weight	Attack couplet				Total
		Wrap	Short bite	Long bite	Wrap	
Crickets (L)						
N.....	100	100	100*			100
Mean.....	389.3	26.6	25.9			123.5
SD.....	115.0	24.1	34.6			105.8
SEM.....	11.5	2.4	3.4			10.6
Range.....	171-720	3-88	0-126			25-280
Pentatomids (L)						
N.....	50	50	50			50
Mean.....	118.1	23.6	30.0			210.6
SD.....	64.8	19.6	26.0			148.0
SEM.....	9.2	2.8	3.7			29.6
Range.....	40-376	4-92	2-170			31-565
Dragonflies (L)						
N.....	50	49	49	1	1	43 ¹
Mean.....	243.4	43.2	18.3	45	14	165.6
SD.....	204.9	47.3	23.7			82.4
SEM.....	29.0	6.7	3.3			12.6
Range.....	90-875	3-146	5-69			91-339
Moths (L): Bite/wrap						
N.....	111			111	111*	111
Mean.....	131.9			53.1	77.8	219.1
SD.....	91.4			69.8	80.9	293.0
SEM.....	8.7			6.6	7.7	28.0
Range.....	44-403			1-527	0-485	42-1040
Moths (L): Wrap/bite						
N.....	23	23	23			23
Mean.....	159.4	25.8	15.7			87.0
SD.....	39.2	24.6	16.1			90.6
SEM.....	9.0	5.1	3.3			16.8
Range.....	95-224	5-105	2-65			36-429
Moths (D): Bite/wrap						
N.....	39			39	39*	39
Mean.....	151.8			79.1	31.6	171.6
SD.....	82.1			58.6	27.6	87.7
SEM.....	13.0			9.3	4.4	13.9
Range.....	57-486			3-245	0-110	55-420
Moths (D): Wrap/bite						
N.....	11	11	11			11
Mean.....	170.7	13.5	9.4			63.5
SD.....	70.6	8.9	6.7			3.5
SEM.....	22.3	2.8	2.1			1.1
Range.....	101-346	5-37	1-25			62-265
Flies (L): Wrap/bite²						
N.....		37	37			37
Mean.....		10.1	9.4			79.3
SD.....		7.1	9.1			44.6
SEM.....		1.2	1.4			7.3
Range.....		1-32	2-45			25-230
Flies (L): Bite/pull out						
N.....					12	12
Mean.....					15.0	36.6
SD.....					16.3	19.1
SEM.....					4.7	5.5
Range.....					1-48	14-80
Flies (D): Wrap/bite²						
N.....		40	40			40
Mean.....		7.7	6.8			61.3
SD.....		6.5	4.7			38.6
SEM.....		1.0	0.7			6.1
Range.....		2-20	1-15			38-154
Flies (D): Bite/pull out						
N.....					8	8
Mean.....					4.0	44.2
SD.....					1.0	23.3
SEM.....					0.4	8.2
Range.....					3-5	25-70

TABLE 3.—Continued

Prey and attack method	Weight	Attack couplet			Wrap	Bite and pull out	Total
		Wrap	Short bite	Long bite			
Flies(D/V): Wrap/bite							
N.....		34	34				34
Mean.....		10.6	9.4				54.4
SD.....		9.6	8.9				19.6
SEM.....		1.6	1.5				3.4
Range.....		3-30	3-32				35-76
Flies(D/V): Bite/pull out							
N.....					16		16
Mean.....					4.5		34.4
SD.....					3.7		21.4
SEM.....					0.9		5.3
Range.....					1-9		22-63

¹ Total time for full sample not known. Spider fed at capture site, or left prey at capture site for long periods.

² A small number of live and dead flies were bitten and wrapped. Sample too small for statistical analysis. N/B flies not weighed individually. Range of weights=.020-.030 gm.

L = Live D = Dead V = Vibrated

SD = Standard deviation

SEM = Standard error of the mean

* Note that some of these units were too short a duration to be scored. See also Table 2.

Trigona sp., repetitions of biting and wrapping were of very low frequency (less than 8 percent in both cases). The rest-at-hub phase was omitted in nearly all the sequences involving small prey (92 percent, or more, of the sequences), and all such prey were transported to the hub in the jaws. Wrapping of the prey at the hub occurred in 98 percent of all the sequences given to small prey.

As far as the durations of behavior units are concerned, the most interesting data are those on bite and wrap times. There is no significant difference between these for the whole range of large prey. The mean wrap time for dragonflies is numerically much larger than that for the heavier crickets and lighter pentatomids but the difference is not statistically significant. The duration of the rest-on-prey phase in sequences involving pentatomids is significantly greater than that occurring in the sequences involving all other types of prey.

Sequences involving moths as prey, that were initiated by the wrap/bite attack couplets, can also be considered at this point. The behavior units involved are essentially similar to those occurring in sequences given to crickets, both in form and order of involvement. The basic sequence is thus: wrap, bite, rest on hub, cut out, carry, and feed. The durations of the attack phases do not differ significantly from those given in the same stages of attack on other types of large prey, except in the case of wrapping attacks on dead moths (where the sample size of ten is probably an inadequate basis for comparison).

SEQUENCES INITIATED BY THE BITE/WRAP ATTACK COUPLET

The greater proportion of all lepidopterans, whether living or dead, whole or mutilated, were subjected to attack by means of the bite/wrap attack couplet. The bite involved in these attacks is significantly longer in duration than the bites given to other insects following wrapping attacks and is also significantly longer in duration than the bites given to lepidopterans after wrapping attacks. The wrapping phase that follows the long bite is longer than the attack wrapping of other insects in the case of live moths but not in the case of dead moths. In this case, however, the variance is extremely great and may be related to the fact that living moths present far more complex trussing and binding problems than do dead moths. The total duration of prey-capture sequences initiated by the bite/wrap attack couplet is much greater than that occurring in the case of insects attacked by the wrap/bite couplet. Comparing total durations for sequences given to lepidopterans of the same range of weights, the mean sequence times for biting attacks are significantly longer than those for sequences initiated by wrapping attacks. In these comparisons the time spent at the hub, between the attack on the prey and its removal from the web and transportation, is not included in the total sequence time, since the spider is then in a position to make further attacks and is not actually involved with the prey.

A rest-on-hub phase, between attack and transportation, occurs at a low frequency in sequences initiated by biting attacks. Other aspects of the prey-capture sequences that were initiated by the bite/wrap couplet are essentially similar to those occurring in sequences given to large prey types, with the notable exception that repetitions of attack behaviors are very infrequent. The occurrence of wrap at hub, after transportation, is correlated with the previous occurrence of the behavior carry in jaws, as was the case with all other sequences. A small number of flies—living, dead, and vibrated—were attacked by the bite/wrap sequences, and sequences initiated in this way contained the same behavior units in the same order of occurrence as did those given to moths.

SEQUENCES INITIATED BY THE SEIZE/PULLOUT ATTACK COUPLET

Sequences that involved the spider seizing the prey in the jaws and then pulling it free from the web were very simple indeed. They occurred only to flies and differ from the small proportion of sequences in which lepidopterans were pulled from the web, after biting, because the pullout movements followed the seizure of the prey without an obvious or measurable pause.

These sequences did not include rest-on-hub or rest-on-prey phases and were simply: seize, pull-out, carry in jaws, wrap at hub, and feed. In mean duration they were shorter than the attacks on flies that were initiated by the other two attack couplets.

Discussion

The behavior of *Argiope argentata* toward different types of prey involves a number of units which occur at different functional stages in the predatory process. The units actually employed in any predatory sequence seem to be related to certain characters of the prey type. This fact led Robinson (1969) to propose a model which described and accounted for some of the major features of the predatory behavior of the spider. The model was intended as a basis for preliminary generalization and further investigation, and was at that stage known to be an oversimplification. There are a large number of problems associ-

ated with attempts to elucidate behavior mechanisms and approach the question of causation. Causal factors can be approached at different levels of analysis and Tinbergen has repeatedly (1969, for instance) emphasized that questions of behavioral ontogeny and evolution are properly part of the question of causality. We have not yet approached the question of the ontogeny of predatory behavior but hope to do so at some stage. Comparative studies carried out by the senior author and co-workers have led to an examination of some of the factors that may have been involved in the evolution of araneid predatory behavior (Robinson, Mirick, and Turner, 1969).

Disregarding ontogenetic and evolutionary problems, it is still possible to pursue the causal analysis of behavior at widely different levels of analysis. Tinbergen has stressed this fact (1951, 1963, 1969) and Hinde (1966) has provided a succinct review of these levels of analysis. Our analysis has been largely concerned with an examination of entire behavior sequences and of the differences between sequences given to different types of prey. In addition, we have investigated some of the types of stimuli that the spider discriminates between, in the course of its predatory behavior, and the effects of the discriminations on the subsequent course(s) of behavior. This latter field has also been investigated by the senior author and co-workers in other studies. The emphasis in all these investigations has been on the external stimuli provided by the prey, and we have not proceeded very far in analyzing the possible effects of the internal state of the spider on its behavior.

Even at this level of analysis the results of the studies of *Argiope argentata* have become more and more complex. We have recast and extended the original model proposed by Robinson (1969) to include our results. The new model is shown in Figure 15.

THE NEW MODEL

The new model is in the form of a conventional flow diagram and uses standard symbols. It includes many of the "decision" or discrimination stages that we have observed, but remains a gross oversimplification. Discriminations that are not included in the diagram certainly occur (particularly those involved in the postattack phases of the predatory sequences). Some of these discriminations are discussed below.

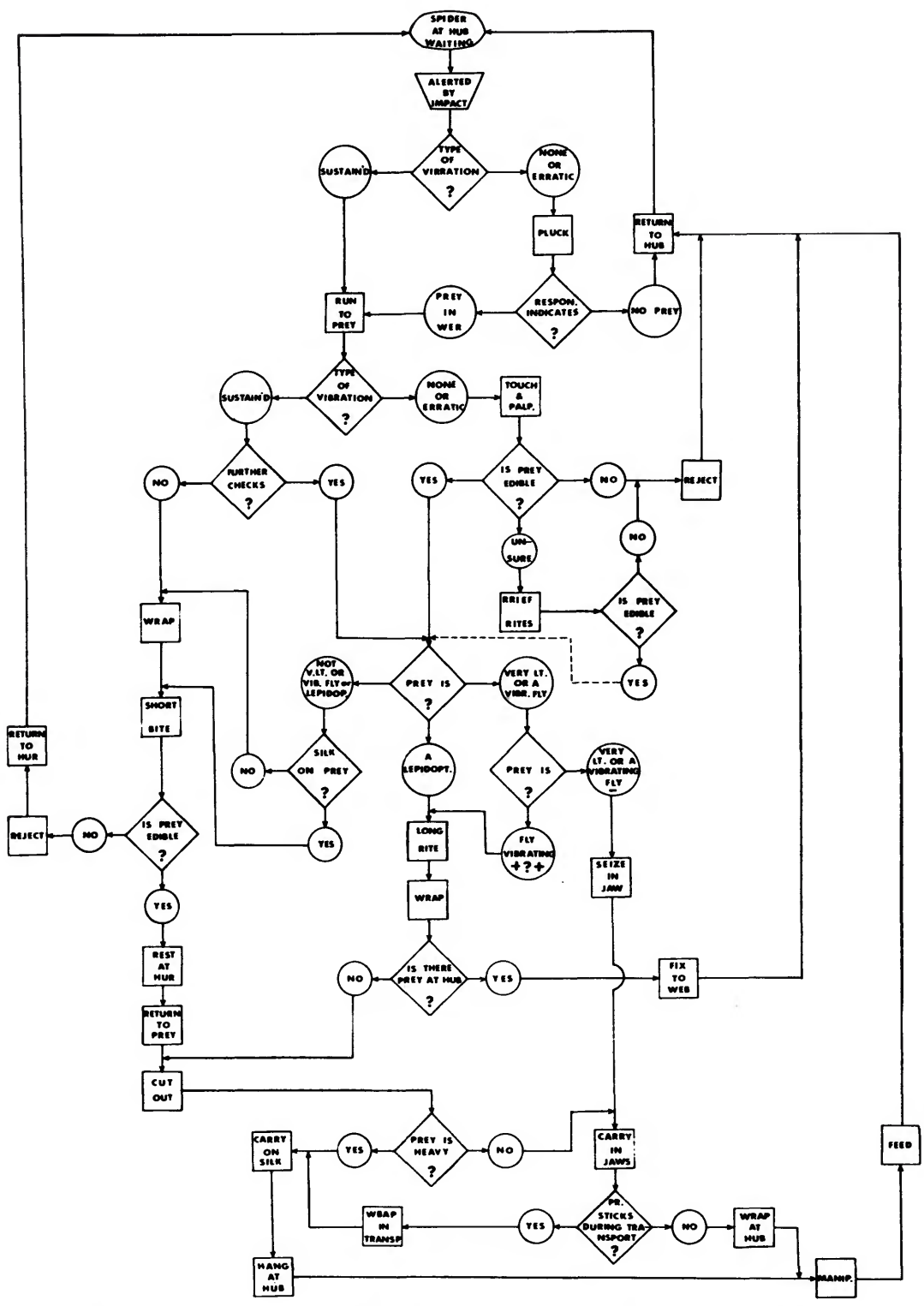

FIGURE 15.—New model of the predatory behavior of *Argiope argentata*. (See text for explanation.)

Essentially the new model differs from that originally proposed by including a more detailed presentation of the discriminatory stages that occur, or can occur, after the spider has contacted an object in the web. In addition, we have used the data obtained by the presentation of artifacts to strengthen Robinson's original suggestion that vibrations may in some cases lead to the suppression of discrimination stages after the spider has contacted the prey (Robinson, 1969, fig. 2, pp. 165–166). We have also added decision stages prior to, and during, the act of transportation. These were not included in the earlier model although some of them were known and described at that stage.

The stages up to the spider running toward the prey are presented as involving the same discriminations as were proposed in the original model. Thus the spider is shown as being alerted by the impact of an object striking the web. If the prey is then continuously vibrating, the spider runs straight toward the prey but otherwise makes plucking movements. These are assumed to be the basis for discriminating between the presence or absence of prey. Note that plucking may also serve to enable the spider to locate prey and may sometimes occur when the prey is continuously vibrating. (The potential dual function of plucking is a matter for further investigation.) It also seems possible that the spider receives information about the size and/or weight of the prey before it leaves the hub on a predatory excursion, or during its approach to the prey. We infer this discrimination because we have found that very large prey are approached slowly, and sometimes even with the anterior legs raised off the web and flexed back over the prosoma. The latter behavior is rarely seen in *A. argentata* but did occur in some sequences in which the prey exceeded .80 gms, irrespective of whether the prey was active or inactive. Very long prey (e.g., 80mm. + phasmids) were also approached in this way. It is noteworthy that the large araneid, *Nephila clavipes*, which attacks all prey by biting, approaches much lighter prey in this way (Robinson and Mirick, in preparation). The flow diagram does not include a discrimination stage, based on weight and size, occurring from the hub or during the approach to prey.

We have seen no differential responsiveness to prey that are vibrating at different frequencies but suspect that *A. argentata* may make frequency discrimi-

nations. The vibration receptors of some araneids appear to be sufficiently sensitive to frequency differences to allow this possibility (Frings and Frings, 1966, Walcott, 1969).

Once the spider has reached the prey, further discriminations can occur. If the prey is in a state of sustained vibration, however, these stages may be suppressed. We believe that this conclusion, arrived at after the senior author's studies of the responses of spiders to artificially vibrated prey, is confirmed by our studies of the responses of *A. argentata* to artifacts. The fact that the greater proportion of vibrating filter tips were wrapped, and then only rejected after exploratory biting, should be contrasted with the response to unvibrated filter tips. The latter were wrapped only in a small number of cases and nearly always subjected to exploratory biting and not wrapping. Such biting apparently enabled the spider to proceed directly to the rejection stage. It is noteworthy that unvibrated "edible" objects are not subjected to exploratory biting but are attacked after a variable, but brief, period of touching. The touching phase may involve both the tarsi and the pedipalps but is sufficient to allow the spider to make the discrimination necessary for the employment of the appropriate attack strategy. The spider is capable also of making this discrimination in the case of vibrating prey. It can effectively block the wrapping response when presented with vibrating prey that are wrapped in spider's silk, and then proceed directly to the short bite that normally occurs after wrapping. The "decision" to wrap or bite, following contact with the prey, is an extraordinarily rapid one in the case of discriminations involving "normal" prey. In the case of vibrating prewrapped crickets, however, there is a very obvious delay at the touch and palpate stage. A similar prolonged contact phase was apparent when we presented plant parts to the spiders. We regard these two instances of prolonged investigation of the prey as being very suggestive.

A discrimination based on the exploratory biting of insects has not been observed. We feel, however, that the fact that this occurred in the case of unvibrated filter tips—and parts of plants—indicates that it is part of the behavioral repertoire of the species. It seems quite probable that all of the edible objects that we presented to the spiders could be "recognized" as edible, on the basis of touching or palpation, but that objects that could not be discriminated

as either edible or inedible are bitten as a final "test" of edibility. This view is supported by the fact that the spider often continues exploratory biting after it has begun rejection behaviors. In functional terms it would clearly be adaptive to attack immediately after the touch and palpation stages reveal positive evidence of edibility. On the other hand, it would also be adaptive to make further checks on the edibility of the object if the information received from touching is equivocal. The new model includes the discrimination stages outlined above and accounts for the behavior that we have observed in response to artifacts and plant parts.

The discrimination stage that we have shown as providing the basis for the seize-and-pullout attack strategy may involve information perceived during the approach to the prey or even prior to this (i.e., from the hub before the predatory excursion). We are presently unsure on this point. The factors which are responsible for the spider attacking some flies by the long bite/wrap couplet are also problematical.

A further discrimination that may be dependent on stored information is that which we have shown preceding the removal of the prey from the web. If there is prey already at the hub, the spider usually leaves the newly caught prey, in situ, at the capture site. We feel that the spider, at this stage, does not check to determine that there is prey at the hub.

Discrimination, or decision, points that are not included in the model can be inferred for a number of stages. Thus we have only included discrimination points preceding the onset of behavior units and none that affect the termination of these behaviors. It seems likely that at least some of the behavior units are terminated when the behavior results in a perceptible change in the stimuli derived from the prey. For instance, wrapping behavior may be terminated when the ensnathing layer reaches a certain state. Certainly the spider moves its pedipalps into contact with the rotating prey package in the later stages of attack wrapping. It could then be using these organs to monitor the ensnathing layer. Alternately the spider could be monitoring the struggles of the ensnathed prey and could stop wrapping when disturbances from within the package reach a certain level. There is the further possibility that the spider can assess the passage of silk through its spinnerets, and feedback from these organs could be involved in the control and termination of wrapping attacks.

Any or all of these relatively simple factors could be involved in the "decision" to stop wrapping. Other behavioral units may have their durations dependent on such decision stages.

INTERNAL FACTORS AND PREDATORY SEQUENCES

The whole question of whether the complex predatory behavior can be attributed to a chain of reflexes, or a rigid and invariable stimulus response chain, is a matter of considerable interest. Peters (1931) described the behavior of *Araneus diadematus* in this way, attributing certain behaviors to the stimulus properties of the prey and others to changes in stimulus properties induced by preceding operations performed by the spider. He showed, for instance, that biting occurred before the prey was carried to the hub and concluded that a stimulus perceived during the bite triggered the carrying response. Later (1933a), however, he modified his original model to include the influence of unspecified internal factors at each stage in the behavior sequence. The influence of internal factors on animal behavior has long been a subject of interest to ethologists and comparative psychologists. Objective criteria for assessing the influence of such factors exist and can be applied. Thus Hinde (1966, p. 134) states, "A given stimulus does not always evoke the same response. If the external situation is constant, altered responsiveness of an animal must be ascribed to changes in its internal state," and proceeds to detail operational procedures for detecting changes in internal state.

Difficulties emerge, in practice, when an experimenter attempts to maintain constant external conditions. In terms of the presentation of objects that are intended to evoke responses from animals, the use of models or dummies is a widely accepted procedure which helps to eliminate variability in stimulus parameters. The variations in responsiveness that we have detected in the behavior of *A. argentata* toward insect prey cannot certainly be attributed to variations in internal state since we cannot eliminate the possibility that there were undetected differences between the insects in each major category. The filter tips, on the other hand, were essentially models, and variations in the responses to these objects are suggestive of internal effects. The suppression of a discrimination stage in some, but not all, encounters with vibrating filter tips may be due to internal state. Similarly the occurrence of complete predatory se-

quences in the responses to filter tips and plant parts, alongside rejections (at various stages) of these objects, is suggestive. Since we did not make repeated presentations of these objects to the same spiders, we cannot separate the possible effects of experience (prior to experiments) from the possible effects of variations in the internal state. The results of the experiments with filter tips are unlikely to have been affected by previous specific experience of these objects, but it is possible that these objects could present the spiders with ambivalent stimulation. Thus they may present the spiders with surface characteristics of prey (being smooth), while, at the same time, lacking other characteristics (the appropriate feedback at the bite stage, for instance). If this is true, it is difficult to account for the fact that some spiders rejected these objects at the touch stage, others at the bite stage, and still others passed both these stages without rejecting the objects. If the filter tips provided the spider with ambivalent stimulation, the resolution of any motivational conflict could be dependent on variations in the attack threshold. Certainly we have seen behavior that appeared to be ambiguous in these circumstances. For instance the spider would approach, touch, and palpate a motionless filter tip and then extrude a small fan of wrapping silk from its spinnerets. It would not then proceed to wrap the prey, however, but would make a series of exploratory bites.

The occurrence of repetitions of elements of the attack couplets (Table 2) suggests that the predatory behavior is more than a simple stimulus response chain. If wrapping terminates when a certain change is effected in the prey package, it is difficult to see why it should be repeated, in some instances, following an intervening behavior. If the prey were alive and struggling intermittently, repetitions of attack elements might occur if the prey recommenced struggling after the termination of an attack behavior. This explanation, however, does not account for repetitions of attack elements in the treatment of dead prey. We have also observed a number of isolated instances of feeding at the capture site (see the accounts of prey-capture sequences) and feel that the suppression of transportation stages may be an effect of hunger. A further elucidation of these matters must await further experimentation, including a more extensive manipulation of the feeding regime and studies of the ontogeny of the predatory behavior.

ADAPTIVE ASPECTS OF THE *A. ARGENTATA* PREDATORY SEQUENCES

Robinson (1969) stressed the adaptive nature of the discrimination of lepidopterans from other insects and the subsequent employment of the long bite attack strategy. Moths and butterflies are known to be able to escape quickly from spider's webs (Eisner et al, 1964). Essentially the loose wing scales of these insects become detached onto the viscid spiral of the web and reduce the adhesion of the insect to the web. The high escape potential that Eisner and co-workers attributed to lepidopterans has been confirmed in a study of the prey caught by a sample population of *A. argentata* in Panama. In this study (Robinson and Robinson, 1970) it was possible to score the number of lepidopterans that escaped from the spiders by the simple expedient of counting areas of web damage on which there were adhering lepidopteran wing scales. In a sample, covering 2,809 web days, over a period of one year, the spiders caught 137 lepidopterans and there were 163 escapes. The total number of escapes for all other insects was 105 (based on web damage where no wing scales were present). Immediate attack biting may be a primitive attack strategy (Eberhard 1967; Robinson, Mirick, and Turner, 1969); its retention for use against prey that have a rapid escape potential, by spiders that have evolved attack wrapping, is probably related to the fact that it ensures the most rapid restraint of such prey. The prey, in fact, is seized in the jaws and frequently grasped tightly against the spider's body by the action of the legs. The initial seizure is essentially similar to that applied to very small prey and differs from that means of attack in not being immediately followed by removal of the prey from the web. It is worth noting that adult trichopterans have loose hairs or scales on their wings and may, in consequence, have a high escape potential. We have not been able to test the responses of *A. argentata* to these insects since they are not abundant in lowland Panama. Bristowe (1941) states that certain wasps and ichneumons have an oily cuticle and may be able to escape rapidly from spiders' webs. It would be interesting to test the responses of orb-web spiders to these insects. In this case the selective advantage of immediate biting might be opposed by counter-selection exerted as a consequence of the dangers involved in close quarters attacks on biting and/or stinging insects.

Since Robinson (1969) reported that *A. argentata* discriminated moths from other insects, the senior author and his co-workers have found that a similar discrimination is made by other araneids. These include *Argiope savignyi*, *A. florida*, *A. aurantia*, *A. trifasciata*, *Eriophora fuliginea*, and *Araneus marmoreus*. We feel that such a discrimination may well be a widespread, though previously undetected, phenomenon among advanced araneids.

The adaptive advantages of attack (=immobilization) wrapping have been suggested by Robinson (1969) and, along with wrapping at other stages in the predatory process, examined in detail by Robinson, Mirick, and Turner (1969). Here, in summary, it can be said that immobilization wrapping enables the spider to reduce its proximity to the prey during the attack phase, thereby reducing the risks of injury by the defensive armature of the prey (mechanical or chemical). It may also effect a considerable economy in time spent away from the hub of the web and a possible economy in energy expenditure (Robinson 1969, p. 170). Post-immobilization wrapping allows the spider the potentiality of leaving the prey securely attached to either the feeding site or the capture site while it makes further attacks, and with immobilization wrapping can permit the spider to transport prey that are too large to be carried in the jaws.

It must also be adaptive for the spider to test the edibility of all objects that it finds in the web and to wrap most vibrating objects with the minimum delay. Our investigations do not provide any evidence of the modification of behavior following experience (learning). There is good evidence that araneids are capable of learning (Le Guelte 1969 for a partial review), and we would expect that learning might affect the spider's discriminatory success. Turnbull's (1960) study of the prey of *Linyphia triangularis* (Clerck) shows how a spider's rejection propensities may shift, seasonally, with the seasonal fluctuations in the types of available prey and that the basis for rejection is not, in many cases, an absolute factor. Such a process, which must ensure an opportunistic exploitation of food sources, must depend on the investigation, prior to either rejection or attack, of all objects in the web. The occasional discrimination failures that we have reported in the case of vibrating prey are probably of little importance in the natural situation, where the overriding advantage will accrue

to the spider that attacks all moving objects. This may be particularly true of spiders that have evolved the strategy of immobilization wrapping, since the dangers involved in the attack phase are probably much reduced, compared with those confronting the spiders whose only attack weapon is the bite. This raises the question of the strength of the selection pressure to discriminate moths and butterflies from other insects. Although these insects only constituted 2.9 percent of the yearly catch of a sample population of spiders by numbers and 5.4 percent by weight (Robinson and Robinson, 1970), we cannot exclude the possibility that their efficient capture may at times be vital for survival. The permissible error level is undoubtedly related to these and other factors.

The seize-and-pullout attack strategy which *A. argentata* applies to small prey is probably adaptive in at least two respects. First, it applies immediate restraint to prey that may only be in contact with a small portion of adhesive silk, and may thereby minimize escapes. Second, it effects removal of prey from the web with minimum damage to this trap. (Thus wrapping attacks on *Trigona* sp. produce web damage at the wrapping stage and also at the subsequent cutout stage). The fact that some lepidopterans are pulled from the web, after the long bite, may be related to their low adhesion to the web, and the process may also serve to minimize damage to the web.

RELATIONS WITH OTHER SPIDERS

In Panama, and probably elsewhere, theridiid kleptoparasites associate with the webs of *A. argentata*. These very small spiders, belonging to the genus *Argyroides*, live on prey caught by the web owner. On many occasions, we have seen their activities during our observations on the behavior of the host species. The theridiids produce a number of complex scaffolding lines above and below the plane of the host web and take prey packages both from the hub of the *Argiope* web and also from the capture sites where the host has left prey in situ. Their behavior is worthy of further investigation. It seems possible that the kleptoparasites are alerted to the host's absence from the hub by the vibrations produced during the host's approach to, and attack upon, newly arrived prey. They then move to the host web

and grope around at the hub until they find the attachment line leading to the prey. At this stage they cut the prey free from the hub of the host web and swing out on their own drag line, eventually carrying the prey on a silk line until they reach a feeding site away from the plane of the host web. Removal of prey packages from capture sites follows a similar pattern, once the theridiids have located the prey. The question of how such packages are located is an interesting one. This prey-location process may involve more complex factors than those involved in finding prey at the hub. The kleptoparasites may be sufficiently light that their movements around the host web are not detected by the vibration receptors of the host, or they may be detected and ignored. On the other hand, the prey-removal process occasionally alerts the host and we have seen the theridiids attacked and treated as prey. Studies are in progress to determine whether the kleptoparasitic "load" is a factor which could cause *A. argentata* to periodically change its web location. Certainly the spider will move its web location under circumstances where it is catching a steady influx of prey. Robinson and Robinson (in preparation) have analyzed the number and composition of the prey items that were stolen from host webs during a thirty-day period. The numbers, mainly of stingless bees, are high enough to suggest that the parasitic effect may be significant to the host's biology.

PROBLEMS FOR FURTHER INVESTIGATION

Throughout this paper we have raised questions about aspects of the predatory behavior of *Agriope argentata* that we feel merit further investigation. It would be tedious repetition to do more than reiterate some of these in brief outline. Light may be shed on some of the problems as the result of comparative studies now in progress or projected. The difficult, for technical reasons, study of the ontogeny of predatory behavior remains untouched and is potentially of great importance. A sophisticated analysis of the sensory discriminations involved in the predatory process is needed to bridge the gap between the broad ethological investigation and the work of the sensory physiologists. The latter have provided information on some of the discriminations that the spider is capable of making, without, in general, providing evidence for their employment in normal behavior sequences.

In the broader field of araneid behavioral ecology, we recognize that there are exciting problems about strategies of web location, web orientation, and web structure. The web avoidance potentials of arthropods are virtually unknown and unexplored. The problems seem limitless and the spiders remain an intellectual challenge.

Summary

A conventional summary of the contents of this paper has been anticipated by the section on comparisons between the behavior sequences and by Tables 2 and 3. The discussion and new model (Figure 15) also have a summary function. The descriptions of behavior units can be located from the contents list, and we feel that an attempt at summarizing this section is unnecessary.

Acknowledgments

We are pleased to acknowledge the assistance that we received during this study. The scientific staff of the Smithsonian Tropical Research Institute have been a constant source of useful guidance at all stages. In particular, Drs. M. H. Moynihan, A. S. Rand, and N. G. Smith have given unsparingly of their time and have discussed many aspects of our work with us. We also received valuable practical help from Mrs. B. Robinson, Misses Heath Mirick and Olga Turner, and Mr. Friedemann Köster. Dr. H. W. Levi (Museum of Comparative Zoology, Harvard) kindly identified the spiders. Dr. P. N. Witt (Department of Mental Health, North Carolina) has been a constant source of encouragement throughout the study. We are most grateful for Mr. Olazarri's work at Barro Colorado Island (May-July 1967) which was made possible by a training grant from the Organization of American States.

Bibliography

- Bristowe, W. S.
1941. *The Comity of Spiders*. Volume II. Ray Society, London.
- Eisner, T. R. Alsop, and G. Ettershank
1964. Adhesiveness of Spider Silk. *Science* 146:1058-1061.
- Eberhard, W.
1967. Attack Behavior of Diguetic Spiders and the Origin of Prey Wrapping in Spiders. *Psyche* 74:173-181.

- Frings, H., and M. Frings
1966. Reactions of Orb-weaving Spiders (Argiopidae) to Airborne Sounds. *Ecology* 47:578-588.
- Hinde, R. A.
1966. *Animal Behaviour*. McGraw-Hill Book Co. London.
- Kaston, B. J., and E. Kaston
1952. *How to Know Spiders*. Wm. C. Brown, Co., Dubuque, Iowa.
- LeGuelte, L.
1969. Learning in Spiders. *American Zoologist* 9:145-152.
- Levi, H. W.
1968. The Spider Genera *Gea* and *Argiope* in America (Araneae:Araneidae). *Bulletin of the Museum of Comparative Zoology, Harvard*. 136:319-352.
- McCook, H. C.
1889. *American Spiders and Their Spinning Work*. Volume I. Philadelphia.
- McCrone, J. D.
1969. Spider Venoms: Biochemical Aspects. *American Zoologist* 9:153-156.
- Peters, H. M.
1931. Die Fanghandlung der Kreuzspinne (*Epeira diademata* L.) Experimentelle Analysen des Verhaltens. *Zeitschrift fur Vergleichende Physiologie*. 15:693-748.
1933a. Weitere Untersuchungen uber die Fanghandlung der Kreuzspinne (*Epeira diademata* Cl.) *Zeitschrift fur Vergleichende Physiologie*. 19:47-67.
1933b. Keine Beitrage zur Biologie der Kreuzspinne *Epeira diademata* Cl. *Zeitschrift fur Morphologie und Okdologie der Tiere*, 26:447-468.
- Robinson, M. H.
1969. Predatory Behavior of *Argiope argentata* (Fabricius). *American Zoologist*, 9:161-174.
- Robinson, M. H., H. Mirick, and O. Turner
1969. The Predatory Behavior of Some Araneid Spiders and the Origin of Immobilization Wrapping, *Psyche, Harvard*. 76:487-501.
- Robinson, M. H., and B. Robinson
1970. Prey Caught by a Sample Population of the Spider *Argiope argentata* in Panama; a Year's Census Data (Araneae; Araneidae). *Zoological Journal of the Linnean Society of London* 49:345-357.
- Robinson, M. H., B. Robinson, and W. Graney
In The Predatory Behavior of the Nocturnal Orb-Web prep. Spider, *Eriophora fuliginea* (C. L. Koch) (Araneae: Araneidae).
- Savory, T. H.
1952. *The Spider's Web*. Warne and Co., Ltd., London.
- Tinbergen, N.
1951. *The Study of Instinct*. Clarendon Press, Oxford.
1963. On Aims and Methods of Ethology. *Zeitschrift fur Tierpsychologie*, 20:410-433.
1969. *The Study of Instinct*. New Introduction. Clarendon Press, Oxford.
- Turnbull, A. L.
1960. The Prey of the Spider *Linyphia triangularis* (Clerck), (Araneae, Linyphiidae). *Canadian Journal of Zoology*, 38:859-873.
- Walcott, C.
1969. A Spider's Vibration Receptor: Its Anatomy and Physiology. *American Zoologist*, 9:133-144.
- Wilson, R. S.
1969. Control of Drag-line Spinning in Certain Spiders. *American Zoologist*, 9:103-111.

Publication in Smithsonian Contributions to Zoology

Manuscripts for serial publications are accepted by the Smithsonian Institution Press, subject to substantive review, only through departments of the various Smithsonian museums. Non-Smithsonian authors should address inquiries to the appropriate department. If submission is invited, the following format requirements of the Press will govern the preparation of copy.

Copy must be typewritten, double-spaced, on one side of standard white bond paper, with 1½" top and left margins, submitted in ribbon copy with a carbon or duplicate, and accompanied by the original artwork. Duplicate copies of all material, including illustrations, should be retained by the author. There may be several paragraphs to a page, but each page should begin with a new paragraph. Number all pages consecutively, including title page, abstract, text, literature cited, legends, and tables. A manuscript should consist of at least thirty pages, including typescript and illustrations.

The *title* should be complete and clear for easy indexing by abstracting services. Taxonomic titles will carry a final line indicating the higher categories to which the taxon is referable: "(Hymenoptera: Sphecidae)." Include an *abstract* as an introductory part of the text. Identify the *author* on the first page of text with an unnumbered footnote that includes his professional mailing address. A *table of contents* is optional. An *index*, if required, may be supplied by the author when he returns page proof.

Two *headings* are used: (1) text heads (boldface in print) for major sections and chapters and (2) paragraph sideheads (caps and small caps in print) for subdivisions. Further headings may be worked out with the editor.

In *taxonomic keys*, number only the first item of each couplet; if there is only one couplet, omit the number. For easy reference, number also the taxa and their corresponding headings throughout the text; do not incorporate page references in the key.

In *synonymy*, use the short form (taxon, author, date, page) with a full reference at the end of the paper under "Literature Cited." Begin each taxon at the left margin with subsequent lines indented about three spaces. Within a taxon, use a period-dash (.—) to separate each entry. Enclose with square brackets any annotation in or at the end of the taxon. For *synonymy* and *references within the text*, use the author-date system: "(Jones 1910)." Use the colon system for page references: "(Jones 1910: 122)," and abbreviate further data: "(Jones 1910: 122, fig. 3, pl. 5: fig. 1)."

Simple *tabulations* in the text (e.g., columns of data) may carry headings or not, but they should not contain rules. Formal *tables* must be submitted as pages separate from the text, and each table, no matter how large, should be pasted up as a single sheet of copy.

Use the *metric system* instead of (or in addition to) the English system.

Illustrations (line drawings, maps, photographs, shaded drawings) can usually be intermixed throughout the printed text. They will be termed *Figures* and should be numbered consecutively; however, if a group of figures is treated as a single figure, the individual components should be indicated by lowercase italic letters on the illustration, in the legend, and in text references: "Figure 9b." Submit all legends on pages separate from the text and not attached to the artwork. An instruction sheet for the preparation of illustrations is available from the Press on request.

In the *bibliography* (usually called "Literature Cited"), spell out book, journal, and article titles, using initial caps with all words except minor terms such as "and, of, the." (For capitalization of titles in foreign languages, follow the national practice of each language.) Underscore (for italics) book and journal titles. Use the colon-parentheses system for volume number and page citations: "10(2):5-9." Spell out such words as "figures," "plates," "pages."

For *free copies* of his own paper, a Smithsonian author should indicate his requirements on "Form 36" (submitted to the Press with the manuscript). A non-Smithsonian author will receive fifty free copies; order forms for quantities above this amount, with instructions for payment, will be supplied when page proof is forwarded.

